



Westcoast Industries

Marina Del Rey, CA 90292

310-651-1038

sales@westcoast-industries.com

www.westcoast-industries.com

SAFETY CATALOG

Full Line of PPE, Plant and Safety Products



Respiratory / Hand Protection / Head & Face Protection / Safety Eyewear
Fall Protection / Protective Clothing / Hearing and more



Safety Products

Welcome to Westcoast Industries, your one-stop-shop for all of your Industrial and Manufacturing supply needs. We are a specialized distributor of Safety, Welding, Manufacturing and Abatement products. As our client, we will devote 24/7 of our time to servicing your account and supplying you with the best products at the best pricing, on time, every time. Our delivery time is 1-2 business days for stocked products from our warehouse in Long Beach, CA.



Phone:

310-651-1038

Monday - Friday
7 AM to 7 PM



Email:

sales@westcoast-industries.com



Website:

www.westcoast-industries.com





TABLE OF CONTENTS

Eye Protection	2-39
Head & Face Protection	40-53
Hearing Protection	54-72
Respiratory Protection	73-98
Hand Protection	99-145
Welding & FR Safety	146-159
Footwear	160-161
Ergonomics	162-163
Fall Protection	164-194
Water Safety	195-200
Protective Clothing	201-214
Cold Weather Gear	215-220
Hi-Viz Apparel	221-230
Lighting	231-240
Instrumentation	241-244
Confined Space	245-247
Heat Stress	248-252
First Aid	253-261
Showers & Eyewash	262-267
Lockout/Tagout	268-274
Wipes & Cleaners	275-279
Sorbents	280-282
Hazardous Storage	283-285
Industrial Markers	286-287
Tapes & Adhesives	288-294
Barricade Tapes	295
Emergency Response	296
Manufacturer Index	297-299
Product Index	300-304

ICON LEGEND

 Ships Direct **FOB Mfg.**

Indicated products are shipped directly from the manufacturer



Some products published in this catalog can expose users to chemicals that are known to the State of California to cause cancer, birth defects or reproductive harm and are identified with a Prop 65 warning. Products have been identified based on manufacturer information and the publisher of this catalog is not responsible for information not provided or changed since the time the catalog is published. For more information visit: www.P65Warnings.ca.gov





Glasses

HexArmor

HexArmor® MX200 Eyewear

- » Rimless lens design with wide field of vision
- » Dual-injection soft-grip side arms for comfort and non-slip fit
- » LTX® Lens Technology for premium optical clarity
- » 100% UV protection
- » Metal-free hinge design
- » Compliant with ANSI Z87.1.2015, CE EN166, CSA Z94.3 (with exception of TruShield®2SF), and High Impact Rated Z87+



11-10001-02

ITEM #	ORDER #	DESCRIPTION	UOM
11-10001-02	E28800891	Green/Grey Temples, Clear Lens, TruShield® Coating	EA
11-10002-03	E28800371	Green/Grey Temples, Clear Lens, TruShield®2F Coating	EA
11-10003-04	E28801031	Green/Grey Temples, Clear Lens, TruShield®S Coating	EA
11-10004-05	E28800311	Green/Grey Temples, Clear Lens, TruShield®2SF Coating	EA
11-10006-02	E28801081	Green/Grey Temples, Grey 23% Lens, TruShield® Coating	EA
11-11003-05	E28801531	Slim Fit, Green/Grey Temples, Clear Lens, TruShield®2SF Coating	EA

HexArmor

HexArmor® MX200G Eyewear

- » Removable foam gasket for multi-application use
- » Dual-injection soft-grip side arms for a low pressure, non-slip fit
- » Clip-on head strap adjusts for a secure fit
- » Integrated channel for eye ventilation
- » LTX® Lens Technology for premium optical clarity
- » 100% UV protection
- » Metal-free hinge design
- » Compliant with ANSI Z87.1.2015, CE EN166, CSA Z94.3, and High Impact Rated Z87+



11-12003-04

ITEM #	ORDER #	DESCRIPTION	UOM
11-12001-04	E28801091	Green/Grey Temples, Clear Lens, TruShield®S Coating	EA
11-12003-04	E28801101	Green/Grey Temples, Grey 23% Lens, TruShield®S Coating	EA

⚠ WARNING: Cancer and Reproductive Harm - www.P65Warnings.ca.gov

HexArmor

HexArmor® MX250 Eyewear

- » Panoramic lens for a wide field of vision
- » Dual-injection adaptive soft-grip side arms for slip-free, stable fit
- » Lightweight, durable construction
- » Built-in brow guard
- » LTX® Lens Technology for premium optical clarity
- » 100% UV protection
- » Metal-free hinge design
- » Compliant with ANSIZ87.1.2015, High Impact Rated Z87+, and CE EN166



11-14004-06

ITEM #	ORDER #	DESCRIPTION	UOM
11-14001-02	E28801111	Green/Grey Frame, Clear Lens, TruShield® Coating	EA
11-14002-02	E28801121	Green/Grey Frame, Amber Lens, TruShield® Coating	EA
11-14003-02	E28801131	Green/Grey Frame, Grey 23% Lens, TruShield® Coating	EA
11-14004-06	E28801141	Green/Black Frame, Silver Mirror 53% Lens, Anti-fog Inside	EA



Glasses

HexArmor

HexArmor® MX300 Eyewear

- » LTX® Lens Technology for premium optical clarity
- » Dual-injection soft-grip side arms for slip-free, stable fit
- » Innovative brow guard provides additional protection from flying particles, dirt, or dust
- » Soft nose piece for comfortable yet durable fit
- » Integrated channel for eye ventilation
- » 100% UV protection
- » Metal-free hinge design
- » Compliant with ANSI Z87.1.2015, High Impact Rated Z87+, CSA Z94.3, and CE EN166



11-13001-02

ITEM #	ORDER #	DESCRIPTION	UOM
11-13001-02	E28801581	Green/Grey Frame, Clear Lens, TruShield® Coating	EA
11-13003-02	E28801591	Green/Grey Frame, Grey 23% Lens, TruShield® Coating	EA



12166-00000-20



3M™ OX™ Safety Eyewear

- » Over-the-glass coverage for prescription eyeglass wearers
- » Adjustable temples
- » DX™ anti-fog hard coat
- » Impact-resistant polycarbonate lens absorbs 99.9% UV
- » Meets the requirements of CSA Z94.3 and ANSI Z87.1-2015

ITEM #	ORDER #	DESCRIPTION	UOM
1000 Series			
12159-00000-20	665570201	Clear Lens, Black Temples	EA
2000 Series			
12166-00000-20	665574651	Clear Lens, Black Temples w/Cord Control System	EA



12261-00000-20



3M™ Privo™ Safety Eyewear

- » European style with the practicality of safety glasses
- » Slight wrap of the lenses offers extra eye protection
- » Soft nose bridge and temple tips cushion high contact points
- » Impact-resistant polycarbonate lens absorbs 99.9% UV
- » Meets the requirements of CSA Z94.3-2007 and ANSI Z87.1-2003

ITEM #	ORDER #	DESCRIPTION	UOM
12261-00000-20	665522631	Clear Lens, Black Frame	EA



3M™ Tour-Guard™ V Protective Eyewear

- » Economical protective eyewear serves needs of site visitors or general use
- » Wraparound side shields help provide extra protection
- » Medium size fits over most personal prescription eyewear
- » Meets the requirements of CSA Z94.3-2007 and ANSI Z87.1-2010
- » Clear polycarbonate lenses absorb 99.9% UVA and UVB up to 380 nm

ITEM #	ORDER #	UOM
TGV01-20	665531535	20/Pk
TGV01-100	66553152	100/Cs



TGV01-20



Glasses

3M

3M™ SecureFit™ 200 Series Protective Eyewear

- » 3M™ Pressure Diffusion Technology allows temples to naturally adjust to individual head sizes
- » Lightweight design weighs less than 1 oz.
- » Snug fit keeps eyewear in place without slippage
- » Polycarbonate lens absorb 99.9% UVA and UVB up to 380 nm
- » Meets the requirements of CSA Z94.3 and ANSI Z87.1-2010



SF202AF



SF201AS

ITEM #	ORDER #	DESCRIPTION	UOM
Anti-Fog Coating			
SF201AF	66552210	Clear Lens, Clear Frame	20/Cs
SF202AF	66552002	Gray Lens, Gray Frame	20/Cs
SF203AF	66552765	Amber Lens, Amber Frame	20/Cs
Anti-Scratch Coating			
SF201AS	66550236	Clear Lens, Clear Frame	20/Cs

3M

3M™ SecureFit™ 400 Series Protective Eyewear

- » 3M™ Pressure Diffusion Technology allows temples to naturally adjust to individual head sizes
- » Lightweight design weighs less than 1 oz.
- » Snug fit keeps eyewear in place without slippage
- » Padded temple touchpoints and soft, adjustable nose pads
- » Polycarbonate lens absorb 99.9% UVA and UVB up to 280 nm
- » Meets the requirements of CSA Z94.3 and ANSI Z87.1-2010



SF401AF

ITEM #	ORDER #	DESCRIPTION	UOM
Anti-Fog Coating			
SF401AF	665527831	Clear Lens, Black Temples	EA
SF401AF-FM	665537961	Clear Lens, Black Temples, w/ Foam Gasket	EA
SF402AF	665527851	Gray Lens, Black Temples	EA
SF402AF-FM	665537981	Gray Lens, Black Temples, w/ Foam Gasket	EA
Indoor/Outdoor Mirror Lens			
SF410AS	665527841	Mirror Lens, Black Temples	EA
SF410AS-FM	665538081	Mirror Lens, Black Temples, w/ Foam Gasket	EA
Replacement Foam Gasket			
SF-FOAM	66554220	Foam Gasket	20/Cs

3M

3M™ SecureFit™ 600 Series Protective Eyewear

- » 3M™ Pressure Diffusion Technology allows temples to naturally adjust to individual head sizes
- » Scotchgard™ Anti-fog Coating lasts longer than traditional anti-fog coatings
- » Soft nosepiece to help reduce slippage
- » Polycarbonate lens absorbs 99.9% UVA and UVB rays
- » Meets the requirements of ANSI Z87.1.2015



SF602SGAF

ITEM #	ORDER #	DESCRIPTION	UOM
SF601SGAF	665537821	Clear Lens, Gray Frame	EA
SF602SGAF	665537831	Gray Lens, Gray Frame	EA
SF601SGAF-FM	665537841	Clear Lens, Black Frame, w/ Foam Gasket	EA



Glasses



11380-00000-20



3M™ BX™ Safety Eyewear

- » Soft nose bridge offers extended wear
- » Adjustable length temples and lens angle allow for customized fit
- » Clear anti-fog polycarbonate lens absorb 99.9% UVA and UVB up to 380 nm
- » Meet the requirements of CSA Z94.3-2007 and ANSI Z87.1-2010

ITEM #	ORDER #	DESCRIPTION	UOM
11380-00000-20	665522531	Silver/Black Frame	EA



15200-00000-20



3M™ Lexa™ Safety Eyewear

- » Wrap style lenses provide full coverage and a wide viewing range
- » Frame is customizable with three lens angles, four temple lengths
- » Soft, adjustable nose bridge cushions a high contact point
- » Clear, 3M™ DX anti-fog coated, polycarbonate lens absorb 99.9% UVA and UVB up to 380 nm
- » Meets the requirements ANSI Z87.1-2003 and CSA Z94.3-2007

ITEM #	ORDER #	DESCRIPTION	UOM
15200-00000-20	665572331	Black Temple, Medium	EA
15100-00000-20	665522211	Black Temple, Large	EA



3M™ Light Vision™ and Light Vision2™ Safety Eyewear with LED Lights

- » Hands-free directed lighting
- » Ultra-bright, adjustable LED lights
- » Long-lasting batteries provide up to 50 hours of continuous use
- » Soft temples and nose bridge, includes microfiber bag and lanyard
- » Impact-resistant, clear polycarbonate lens with anti-fog coating absorb 99.9% UV
- » Meets the requirements of ANSI Z87.1-2003



11356-00000-10

ITEM #	ORDER #	DESCRIPTION	UOM
11356-00000-10	665520801	Light Vision, Gray Temple	EA

Light Vision2™ Meets CSA Z94.3

11476-00000-10	665574241	Light Vision2, Gray Temple	EA
----------------	-----------	----------------------------	----



Glasses

3M

3M™ Metaliks™ and Metaliks™ Sport Safety Eyewear

- » Adjustable bridges and soft, comfortable spatula temples with soft tips
- » High wrap lens for additional viewing area
- » Polycarbonate lens with anti-fog coating absorb 99.9% UV
- » Meets the requirements of CSA Z94.3-2007 and ANSI Z87.1-2010

ITEM #	ORDER #	DESCRIPTION	UOM
Metaliks			
15170-10000-20	665521141	Clear Lens, Polished Metal Frame	EA
15171-10000-20	665572011	Gray Lens, Polished Metal Frame	EA
15172-10000-20	665564181	Indoor/Outdoor Mirror Hard Coat Lens, Polished Metal Frame	EA
Metaliks Sport			
11343-10000-20	665521191	Clear Lens, Brushed Nickel Frame	EA



15170-10000-20



11343-10000-20

3M

3M™ Nuvo™ Safety Eyewear

- » Lightweight, retro-styled Nuvo features adjustable temples, an integral brow bar and soft nosepiece
- » Dual lens profile in a one-piece lens design
- » Impact-resistant polycarbonate anti-fog lens absorb 99.9% UVA and B
- » Meets the requirements ANSI Z87.1-2003 and CSA Z94.3-2007

ITEM #	ORDER #	DESCRIPTION	UOM
11411-00000-20	665522821	Clear Lens, Gray Frame	EA
11412-00000-20	665522831	Gray Lens, Gray Frame	EA



11411-00000-20

3M

3M™ Smart Lens™ Protective Eyewear

- » Photochromic lenses darken and lighten as the outdoor light changes
- » Transition from light to dark takes less than 20 seconds and dark to light takes less than 3 minutes
- » Spring-adjusted temples allow for a flexible fit
- » Strong frame with magnesium alloy temples
- » Soft, adjustable nose bridge and nylon brow enhance comfort
- » Meets the requirements of ANSI Z80.3-2008 and ANSI Z87.1-2010
- » Polycarbonate lenses absorb 99.9% UVA and UVB



13407-00000-5

ITEM #	ORDER #	DESCRIPTION	UOM
13407-00000-5	665522461	Anti-Fog Lens, Black Frame	EA



Glasses



S1101SGAF-KT



S1202SGAF-SKT



3M™ Solus™ 1000 Series Protective Eyewear

- » Scotchgard™ Anti-fog Coating lasts longer than traditional anti-fog coatings
- » Reliable, clearer sight longer, because the coating is bonded to the lens
- » Soft nosepiece to help reduce slippage
- » Polycarbonate lens absorbs 99.9% UV rays
- » Meets the requirements of ANSI Z87.1 and CSA Z94.3
- » Kits includes: Glasses, elastic strap and foam gasket

ITEM #	ORDER #	DESCRIPTION	UOM
S1101SGAF	665531871	Clear Lens, Blue and Black Frame	EA
S1101SGAF-KT	665531321	Kit w/ Clear Lens, Blue and Black Frame	EA
S1102SGAF	665534421	Gray Lens, Blue and Black Frame	EA
S1103SGAF	665534511	Amber Lens, Blue and Black Frame	EA
S1201SGAF	665532901	Clear Lens, Green and Black Frame	EA
S1201SGAF-KT	665532911	Kit w/ Clear Lens, Green and Black Frame	EA
S1202SGAF	665534431	Gray Lens, Green and Black Frame	EA
S1203SGAF	665534441	Amber Lens, Green and Black Frame	EA
S1102SGAF-KT	665538181	Kit w/ Gray Lens, Blue and Black Frame	EA
S1202SGAF-KT	665538171	Kit w/ Gray Lens, Green and Black Frame	EA
S1107SGAF	665538131	Indoor/Outdoor Gray Lens, Blue and Black Frame	EA
S1207SGAF	665538121	Indoor/Outdoor Gray Lens, Green and Black Frame	EA

Kit Without Temples – Glasses, Elastic Strap and Foam Gasket

S1201SGAF-SKT	665538141	Clear Lens, Green and Black	EA
S1202SGAF-SKT	665538151	Gray Lens, Green and Black	EA
S1207SGAF-SKT	665538161	Indoor/Outdoor Gray Lens, Green and Black	EA

Replacement Parts

SOLUS-FOAM	665534531	Replacement Foam Gasket	EA
SOLUS-STRAP	66553455	Replacement Elastic Strap	10/Bg



Glasses



11818-00000-20



3M™ Virtua™ AP Protective Eyewear

- » Lightweight wraparound lens, integrated side-shields and contoured temples
- » Meets the requirements of CSA Z94.3-2007 and ANSI Z87.1-2010
- » Polycarbonate lenses absorb 99.9% UVA and UVB

ITEM #	ORDER #	DESCRIPTION	UOM
11815-00000-20	665570451	Gray Lens, Gray Frame	EA
11818-00000-20	665550751	Clear Lens, Clear Frame	EA
11819-00000-20	665525241	Clear Hard Coat Lens, Clear Frame	EA
11847-00000-20	665540231	Indoor/Outdoor Mirror Lens and Frame	EA



11328-00000-20



3M™ Virtua™ Frameless Safety Eyewear

- » Lightweight, weighs less than an ounce
- » Wraparound design provides extended eye protection
- » Meets the requirements of ANSI Z87.1-2010
- » Polycarbonate lenses absorb 99.9% UVA and UVB

ITEM #	ORDER #	DESCRIPTION	UOM
11228-00000-100	665525881	Clear Uncoated Lens and Frame	EA
11326-00000-20	665564381	Clear Hard Coat Lens and Frame	EA
11329-00000-20	665570161	Clear Anti-Fog Lens and Frame	EA
11328-00000-20	665570151	Indoor/Outdoor Mirror Lens and Frame	EA
11327-00000-20	665570141	Gray Hard Coat Lens and Frame	EA
11330-00000-20	665570171	Gray Anti-Fog Lens and Frame	EA
11331-00000-20	665570181	Blue Mirror Hard Coat Lens and Frame	EA



11872-00000-20



3M™ Virtua™ CCS Protective Eyewear with Foam Gasket

- » Temple design holds the cord of the earplug in place and untangled
- » CCS feature allows the corded earplugs to dual as a lanyard
- » Foam gasket limits eye exposure to dust while providing cushioning
- » Meets the requirements of ANSI Z87.1-2010 and CSA Z94.3-2007
- » Anti-fog polycarbonate lenses absorb 99.9% UVA and UVB

ITEM #	ORDER #	DESCRIPTION	UOM
11872-00000-20	665527311	Clear Lens, Light Blue Temples	EA
11873-00000-20	665527301	Gray Lens, Gray Frames	EA



11670-00000-20



3M™ Virtua™ V4 Safety Eyewear

- » Lightweight, frameless
- » Dual-injected black/gray temples
- » Soft nose bridge, wraparound lens
- » Meets the requirements of ANSI Z87.1-2003
- » Polycarbonate lenses absorb 99.9% UV

ITEM #	ORDER #	DESCRIPTION	UOM
11670-00000-20	665564111	Clear Hard Coat Lens	EA
11672-00000-20	665573851	Clear Anti-Fog Lens	EA
11671-00000-20	665564121	Gray Hard Coat Lens	EA
11673-00000-20	665570321	Gray Anti-Fog Lens	EA
11674-00000-20	665570331	Indoor/Outdoor Mirror Lens	EA



Glasses



A401

Honeywell
UVEX®

Uvex A400 Series Safety Glasses

- » Frameless, Uni-lens, wrap-around lens
- » Hardcoat, anti-scratch polycarbonate lens
- » Dielectric
- » Meets ANSI Z87.1 and CSA Z94.3 standard

ITEM #	ORDER #	DESCRIPTION	UOM
A400	341529321	Clear Lens, Clear Frame	EA
A401	341529331	Clear Lens, Gray Frame	EA
A403	341529351	Silver Mirror Lens, Gray Frame	EA



A801

Honeywell
UVEX®

Uvex A800 Series Safety Glasses

- » 9-base hard coated polycarbonate, distortion-free lenses
- » Non-slip rubber nose bridge
- » Temples with soft, padded inserts down the length of the temple
- » Extra "flex" built into the temple for increased tension control
- » Provides 99.9% UV protection
- » Meets ANSI Z87.1 standard

ITEM #	ORDER #	DESCRIPTION	UOM
A800	341529431	Clear Lens, Clear Frame	EA
A801	341529441	TSR® Gray Lens, Gray Frame	EA
A804	341529451	I/O Silver Mirror Lens, Gray Frame	EA
A805	341529461	Uvextra® Anti-Fog Coating Lens, Clear Frame	EA



A700

Honeywell
UVEX®

Uvex A700 Series Safety Glasses

- » Frameless, Uni-lens, secure wrap-around design
- » Soft temple tip pads for comfortable fit
- » 9-base polycarbonate, distortion-free, hardcoat lenses
- » Provides 99.9% UV protection
- » Meets ANSI Z87.1 and CSA Z94.3 standard

ITEM #	ORDER #	DESCRIPTION	UOM
A700	341529371	Clear Lens, Clear Frame	EA
A701	341529381	TSR® Gray Lens, Gray Frame	EA
A702	341529391	Amber Lens, Amber Frame	EA
A703	341529401	Blue Mirror Lens, Gray Frame	EA
A704	341529411	I/O Silver Mirror Lens, Gray Frame	EA
A705	341529421	Uvextra® Anti-Fog Coating Lens, Clear Frame	EA



S1600

Honeywell
UVEX®

Uvex Bandit Safety Glasses

- » Wrap-around temples provide non-slip fit and comfort
- » Adjustable temple length
- » Easy lens replacement system
- » Ultra-dura® HC polycarbonate lens coating
- » Meets ANSI Z87.1 and Military V₀ ballistic test for impact
- » Additional lens styles available

ITEM #	ORDER #	DESCRIPTION	UOM
S1600	341530791	Clear Lens, Black Frame	EA
S1603	341530821	Espresso Lens, Black Frame	EA
S1604	341530841	Gold Mirror Lens, Black Frame	EA



Glasses

Honeywell
UVEX®

Uvex Avatar™ and Avatar™ OTG Safety Glasses

- » 9-base wrap-around lens provides uncompromised peripheral vision and protection
- » Ratchet, wire-core, adjustable temples, flexible nose, MMT
- » Indirect venting system, soft brow frame with MMT
- » Unique Weight Distribution Technology
- » Meets CSA Z94.3 standard and ANSI Z87.1+ - 2015



S1359

S2860HS

ITEM #	ORDER #	DESCRIPTION	UOM
Avatar			
S2850HS	341578581	Clear HydroShield Anti-Fog Lens, Black Frame	EA
S2860HS	341578591	Clear HydroShield Anti-Fog Lens, Red Frame	EA
S2670HS	341578601	Clear HydroShield Anti-Fog Lens, Blue Frame	EA
Avatar OTG			
S3850	341579701	Anti-Scratch Coating, Clear Lens, Black Frame	EA
S3851	341579711	Anti-Scratch Coating, Clear Lens, Red Frame	EA
S3852	341579721	Anti-Scratch Coating, Gray Lens, Red Frame	EA
S3853	341579731	Anti-Scratch and Anti-Reflective Coating, Clear Lens, Blue Frame	EA

Honeywell
UVEX®

Uvex Tomcat Safety Glasses

- » Lightweight, durable 10-base wrap-around lenses with metal frame
- » Adjustable saddle nose pads for comfort and fit
- » Anti-scratch hard coated polycarbonate lens provides 99.9% UV protection
- » Meets ANSI Z87+ standard



S2451

ITEM #	ORDER #	DESCRIPTION	UOM
S2450	341531571	Clear lens, Gunmetal Color Frame	EA
S2451	341531581	Gray lens, Gunmetal Color Frame	EA
S2453	341531591	Silver Mirror Lens, Gunmetal Color Frame	EA
S2454	341531601	Mirror 50 Lens, Gunmetal Color Frame	EA

Honeywell
UVEX®

Uvex Hypershock® Safety Glasses

- » High-performance protection and sport-inspired styling
- » Full-frame design with padded temples and a molded nosepiece
- » Uvextreme Plus® anti-fog lens coating lasts up to 10X longer and 2X better scratch-resistance than other anti-fog coated products
- » Dielectric, meets the ANSI Z87.1 standard



S2970XP

ITEM #	ORDER #	DESCRIPTION	UOM
S2970XP	341597631	Uvextreme Plus® Anti-Fog Clear Lens, Clear Ice Frame	EA



Glasses



Uvex Genesis Safety Glasses

- » MMT – Multi- Material Technology® frame provides all-day comfort
- » Extended 9-base wrap-around lens for extra side coverage
- » Soft elastomer brow guard diffuses and deflects impact
- » Easy lens replacement system
- » Adjustable cushioned temples and lens inclination
- » Polycarbonate lens provides 99.9% UV protection
- » Meets CSA Z94.3 standards, ANSI Z87.1 and Military V₀ ballistic test for impact



S3202



S3240

ITEM #	ORDER #	DESCRIPTION	UOM
S3200	341532271	Ultra-dura® Anti-Scratch Clear Lens, Black Frame	EA
S3200X	341532281	Uvextreme® Anti-Fog Clear Lens, Black Frame	EA
S3201	341532291	Ultra-dura® Anti-Scratch Espresso Lens, Black Frame	EA
S3201X	341532301	Uvextreme® Anti-Fog Espresso Lens, Black Frame	EA
S3202	341532311	Ultra-dura® Anti-Scratch Amber Lens, Black Frame	EA
S3203	341532331	Ultra-dura® Anti-Scratch Gold Mirror Lens, Black Frame	EA
S3207	341532371	Shade 3.0 Infra-dura®- Ultra-dura® Anti-Scratch Lens, Black Frame	EA
S3208	341532381	Shade 5.0 Infra-dura®- Ultra-dura® Anti-Scratch Lens, Black Frame	EA
S3209	341532391	SCT-Low IR Ultra-dura® Anti-Scratch Lens, Black Frame	EA
S3240	341532511	Ultra-dura® Anti-Scratch Clear Lens, Vapor Blue Frame	EA
S3240X	341532521	Uvextreme® Anti-Fog Clear Lens, Vapor Blue Frame	EA



Uvex Livewire™ Sealed Eyewear

- » Foam-lined sub frame is engineered to offer comfort and a gap-free seal around the eyes to keep debris out
- » 8.0 base lens, wraparound frame design accommodates respirators and other PPE, while the temples fit with earmuffs
- » Flexible design can be worn with a headband like a goggle or with temples like a spectacle
- » Ratcheting temples adjust lens up to 15° for coverage and air circulation
- » Uvextreme Plus® anti-fog lens coating lasts up to 10X longer and 2X better scratch-resistance than other anti-fog coated products
- » Rx Safety Frame Option Available (SW09 Livewire)
- » Dielectric, meets CSA Z94.3 and ANSI Z87.1 standards



S2601XP



S2607XP

ITEM #	ORDER #	DESCRIPTION	UOM
S2601XP	341592641	Uvextreme Plus® Anti-Fog Espresso Lens, Matte Black Frame	EA
S2602XP	341592651	Uvextreme Plus® Anti-Fog Amber Lens, Matte Black Frame	EA
S2604XP	341592661	Uvextreme Plus® Anti-Fog SCT-Reflect 50 Lens, Matte Black Frame	EA
S2607XP	341592681	Uvextreme Plus® Anti-Fog Shade 3.0 Lens, Matte Black Frame	EA
S2608XP	341592691	Uvextreme Plus® Anti-Fog Shade 5.0 Lens, Matte Black Frame	EA
S2609XP	341592701	Uvextreme Plus® Anti-Fog SCT-Low IR Lens, Matte Black Frame	EA



Glasses

Honeywell
UVEX®



XV201

Uvex Tectonic™ Safety Eyewear

- » Weighs less than one ounce (25.2 grams)
- » Flexible temples provide just the right amount of tension to comfortably keep eyewear in place
- » Wrap-around 9-base curve lens offers a close fit with excellent side protection
- » Meets ANSI Z87.1-2010 standard

ITEM #	ORDER #	DESCRIPTION	UOM
XV201	341577851	TSR Gray, Hardcoat Anti-scratch Lens, Black Gloss Temple	EA

Honeywell
UVEX®



SVP205

Uvex SVP 200 Series Safety Eyewear

- » Dielectric, 10 base wraparound lens offers optimum protection
- » Very lightweight and low-profile at 15 grams
- » Polycarbonate lens with Uvextra Anti-Fog Coating
- » ANSI & CSA Certified

ITEM #	ORDER #	DESCRIPTION	UOM
SVP201	341578531	Clear Lens AF, Clear Frame	EA
SVP203	341578541	Gray Lens AF, Gray Frame	EA
SVP205	341578551	Clear Lens AF, Blue Frame	EA
SVP208	341578561	Clear Lens AF, Pink Frame	EA

Honeywell
UVEX®

Uvex Ambient® OTG Safety Glasses

- » Exceptional peripheral vision and coverage in a lightweight, wraparound Uni-lens design
- » Adjustable and bendable, wire-core temples with inclination
- » Soft, flexible nasal fingers conform for minimize slippage
- » Coated polycarbonate lens
- » Meets Z87.1 (High Impact) and CSA Z94.3 standards

ITEM #	ORDER #	DESCRIPTION	UOM
S3150	341559561	Ultra-dura® Anti-Scratch Clear Lens, Blue Frame, Size Large	EA

Honeywell
UVEX®



S1900

Uvex Skyper Safety Glasses

- » Wrap-around protective eyewear offers exceptional comfort, protection and fit
- » Easy lens replacement system
- » Adjustable Duoflex® cushioned temples and lens inclination
- » Clear polycarbonate lens provides 99.9% UV protection
- » Meets CSA Z94.3 standards, ANSI Z87.1 and Military V₀ ballistic test for impact

ITEM #	ORDER #	DESCRIPTION	UOM
S1900	341531091	Ultra-dura® Anti-Scratch Clear Lens, Black Frame	EA
S1905	341531161	SCT-Reflect 50 Lens, Ultra-dura Anti-scratch, Black Frame	EA
S1933X	341531231	SCT-Orange Lens, Uvextreme Anti-fog, Black Frame	EA

Honeywell
UVEX®



SVP300

Uvex SVP 300 Series Safety Eyewear

- » 10-base wrap-around coverage
- » Flexible, "bone & tendon" temples for secure fit
- » Lens filters > 99.9% UVB/UVA for far and near UV transmittance
- » Dielectric frame
- » Certified to meet ANSI+ 2015

ITEM #	ORDER #	DESCRIPTION	UOM
SVP301	341578571	Clear Lens AF, Clear Frame	EA



S3150



Glasses

Honeywell
UVEX®



S0360X

Uvex Ultra-spec® 2000 Safety Glasses

- » Lightweight, wrap-around Uni-lens design
- » Adjustable spatula temple length
- » Coated polycarbonate lens
- » Meets ANSI Z87+ and CSA Z94.3 standards

ITEM #	ORDER #	DESCRIPTION	UOM
S0250X	341529971	Uvextreme® Anti-Fog Clear Lens, Clear Frame	EA
S0300	341530001	Ultra-dura® Anti-Scratch Clear Lens, Clear Frame	EA
S0360X	341530031	Uvextreme® Anti-Fog Orange Lens, Orange Frame	EA

Honeywell
UVEX®



S0112

Uvex Ultra-spec® 2001 OTG Safety Glasses

- » Lightweight, over-the-glass Uni-lens design fits over most Rx eyewear
- » Adjustable Duoflex® cushioned temples
- » Coated polycarbonate lens
- » Meets ANSI Z87+ and CSA Z94.3 standards

ITEM #	ORDER #	DESCRIPTION	UOM
S0112	341529931	Ultra-dura® Anti-Scratch Clear Lens, Clear Frame	EA

Honeywell
UVEX®

Uvex Astrospec® OTG 3001 Safety Glasses

- » Lightweight Uni-lens offers OTG (over-the-glass) panoramic vision
- » An economical alternative to expensive Rx eyewear
- » Adjustable lens inclination and Duoflex® cushioned temple length
- » Easy lens replacement system
- » Coated polycarbonate lens
- » Meets CSA Z94.3 standards, ANSI Z87.1 and Military V₀ ballistic test for impact



S2508

ITEM #	ORDER #	DESCRIPTION	UOM
S2500	341531611	Ultra-dura® Anti-Scratch Clear Lens, Black Frame	EA
S2500C	341531621	Uvextreme® Anti-Fog Clear Lens, Black Frame	EA
S2504	341531651	Ultra-dura® Anti-Scratch Gray Lens, Black Frame	EA
S2508	341531701	Shade 3.0 Infra-dura®- Ultra-dura® Anti-Scratch Lens, Black Frame	EA
S2509	341531711	Shade 5.0 Infra-dura®- Ultra-dura® Anti-Scratch Lens, Black Frame	EA

Honeywell
UVEX®

Uvex Astrospec 3000® Safety Glasses

- » Lightweight Uni-lens offers panoramic vision
- » Adjustable lens inclination and temple length
- » Easy lens replacement system
- » Coated polycarbonate lens
- » Meets CSA Z94.3 standard, ANSI Z87.1 and Military V₀ ballistic test for impact



S1359

ITEM #	ORDER #	DESCRIPTION	UOM
Spatula Temples			
S135	341530621	Ultra-dura® Anti-Scratch Clear Lens, Black Frame	EA
S1112	341530471	Shade 5.0 Infra-dura®- Ultra-dura® Anti-Scratch Lens, Black Frame	EA
Duoflex® Temples			
S1359	341530641	Ultra-dura® Anti-Scratch Clear Lens, Black Frame	EA
S1359C	341530651	Uvextreme® Anti-Fog Clear Lens, Black Frame	EA



Glasses

Honeywell
UVEX®

Uvex Protégé® Safety Glasses

- » Proprietary Floating Lens® design offers increased flexibility and fit
- » Ultra-lightweight design at only 27.5 grams, weighs less than one ounce
- » Secure wrap-around brow expands to fit a wide range of users
- » Soft temple tip pads provide a secure fit
- » Soft, clear nose pads prevent slipping
- » Polycarbonate lenses offer 99.9% UV protection
- » Meets CSA Z94.3 standard, ANSI Z87.1 and Military V₀ ballistic test for impact



S4201

ITEM #	ORDER #	DESCRIPTION	UOM
S4200	341533181	Ultra-dura® Anti-Scratch Clear Lens, Metallic Black Frame	EA
S4200X	341533191	Uvextra® Anti-Fog Clear Lens, Metallic Black Frame	EA
S4201	341533221	Ultra-dura® Anti-Scratch Gray Lens, Metallic Black Frame	EA
S4201X	341533231	Uvextra® Anti-Fog Gray Lens, Metallic Black Frame	EA
S4202	341533261	Ultra-dura® Anti-Scratch SCT Reflect 50 Lens, Metallic Black Frame	EA

Honeywell
UVEX®

Uvex Protégé® Safety Glasses with HydroShield™

- » Proprietary Floating Lens® design offers increased flexibility and fit
- » Ultra-lightweight design at only 27.5 grams, weighs less than one ounce
- » Secure wrap-around brow expands to fit a wide range of users
- » Soft temple tip pads provide a secure fit
- » Soft, clear nose pads prevent slipping
- » Polycarbonate lenses offer 99.9% UV protection
- » Meets CSA Z94.3 standard, ANSI Z87.1 and Military V₀ ballistic test for impact



S4200HS

ITEM #	ORDER #	DESCRIPTION	UOM
S4200HS	314042001	Hydroshield™ Anti-Fog Clear Lens, Metallic Black Frame	EA
S4201HS	314042011	Hydroshield™ Anti-Fog Gray Lens, Metallic Black Frame	EA

Honeywell
UVEX®

Uvex Seismic® Sealed Eyewear

- » Sealed eyewear that protects against impact, sunlight, dust and debris
- » Flame-resistant, cushioned-lined sub frame, and a removable headband (included) for all-day comfort
- » Padded temple tips, flexible nose pads
- » 8-base polycarbonate lenses offer 99.9% UV protection
- » Dielectric frame, meets CSA Z94.3 standards



S0600X

ITEM #	ORDER #	DESCRIPTION	UOM
S0600	341560741	Hardcoat Clear Lens, Black Frame	EA
S0600X	341558841	Uvextra® Anti-Fog Clear Lens, Black Frame	EA
S0601X	341558851	Uvextra® Anti-Fog Espresso Lens, Black Frame	EA
S0604X	341559391	Uvextra® Anti-Fog SCT Reflect 50 Lens, Black Frame	EA
S0620X	341539181	Uvextra® Anti-Fog Clear Lens, Metallic Blue Frame	EA



Glasses



Uvex Tirade™ Sealed Eyewear

- » Sealed eyewear that protects against impact, sunlight, glare, dust and debris
- » Indirect ventilation channels on the foam and sub frame provide superior dust filtration
- » Frameless, Uni-lens allows for wide-field peripheral vision
- » Quick-release hinge system converts temples to headband (included)
- » Removable foam sub frame, padded temple tips and flexible nose pads
- » Uvextra® anti-fog coated lens reduces fogging, keeping lenses clear and offers 99.9% UV protection
- » Dielectric, meets CSA Z94.3 standard, ANSI Z87.1



S4040



S4041

ITEM #	ORDER #	DESCRIPTION	UOM
S4040	341564881	Uvextra® Anti-Fog Clear Lens, Gloss Black Frame	EA
S4041	341569801	Uvextra® Anti-Fog Gray Lens, Gloss Black Frame	EA
S4042	341569811	Uvextra® Anti-Fog Amber Lens, Gloss Black Frame	EA
S4043	341569821	Uvextra® Anti-Fog Silver Mirror Lens, Gloss Black Frame	EA
S4044	341569831	Uvextra® Anti-Fog SCT-Reflect 50 Lens, Gloss Black Frame	EA

Hypo-Allergenic, Latex-Free Fabric Headband

S4049	341569841	Black	EA
-------	-----------	-------	----



14470



KleenGuard™ Visio* Safety Glasses

- » Dual-tone frame with three-point extendable temples help give a customized fit and enhanced comfort
- » ANSI Z87.1+ standard for impact protection and are TAA compliant
- » Hard coated polycarbonate lenses provide 99.9% UVA/UVB/UVC protection

ITEM #	ORDER #	DESCRIPTION	UOM
14470	C24119131	Clear Lens, Black Frame	EA
14471	C24119891	Clear Anti-Fog Lens, Black Frame	EA
14472	C24119151	Smoke Lens, Black Frame	EA
14473	C24119901	Smoke Anti-Fog Lens, Silver/Black Frame	EA
14474	C24119171	Amber Lens, Black Frame	EA
14476	C24119191	Indoor/Outdoor Lens, Black Frame	EA



20541



KleenGuard™ Hellraiser* Safety Glasses

- » Lightweight single lens wraparound protection
- » Flex-point temples provide comfort and stability
- » Meets ANSI Z87.1+ standards
- » Hard coated polycarbonate lenses provide 99.9% UVA/UVB/UVC protection

ITEM #	ORDER #	DESCRIPTION	UOM
20539	C24121001	Clear Lens, Black Frame	EA
20541	C24121031	Amber Lens, Black Frame	EA
20544	C24121071	IRUV 3.0 Lens, Black Frame	EA
20545	C24121081	IRUV 5.0 Lens, Black Frame	EA
25714	C24121021	Smoke Lens, Black Frame	EA
25716	C24121041	Indoor/Outdoor Lens, Black Frame	EA
28615	C24121011	Clear Anti-Fog Lens, Black Frame	EA



Glasses



14481



19642



22610



47378



29111



20746



KleenGuard™ Nemesis* Safety Glasses

- » Glasses feature a sporty, flexible, lightweight design
- » Meets ANSI Z87.1+2010 standards for personal eye protection
- » Polycarbonate lenses provide 99.9% UVA/UVB/UVC protection
- » Patented FLEX-DRY* nose piece is extremely flexible, to channel sweat away, and to help prevent slippage down the nose

ITEM #	ORDER #	DESCRIPTION	UOM
14481	C24133581	Blue Mirror Lens, Black Frame	EA
19639	C24120301	Light Blue Lens, Black Frame	EA
19642	C24120311	Copper Blue Shield Lens, Black Frame	EA
19644	C24120321	Bronze Lens, Camouflage Frame	EA
22475	C24124701	Smoke Anti-Fog Lens, Black Frame	EA
22608	C24129781	Clear Anti-Fog Lens, Camouflage Frame	EA
22609	C24124441	Smoke Anti-Fog Lens, Camouflage Frame	EA
22610	C24137081	Amber Anti-Fog Lens, Camouflage Frame	EA
22611	C24124381	Smoke Lens, Red Frame	EA
25659	C24119491	Amber Lens, Black Frame	EA
25671	C24119511	IRUV Shade 5.0 Lens, Black Frame	EA
25676	C24119441	Clear Lens, Black Frame	EA
25679	C24119451	Clear Anti-Fog Lens, Black Frame	EA
25685	C24124161	Indoor/Outdoor Lens, Black Frame	EA
25688	C24126061	Smoke Mirror Lens, Black Frame	EA
25692	C24119501	IRUV 3.0 Lens, Black Frame	EA
47378	154005011	Clear Anti-Fog Lens, Red Frame	EA
47383	154005101	Smoke Anti-Fog Lens, Silver Frame	EA
47384	154005001	Clear Anti-Fog Lens, Blue Frame	EA
47387	154005071	Smoke Anti-Fog Lens, Blue Frame	EA
47388	154005051	Clear Anti-Fog Lens, Silver Frame	EA

Polarized

28635	C24186351	Polarized Smoke Lens, Black Frame	EA
28637	C24186371	Polarized Brown Lens, Black Frame	EA
47417	154004991	Polarized Smoke Lens, Camouflage Frame	EA



KleenGuard™ Nemesis* VL Safety Glasses

- » Lightweight and frameless for long-term comfort
- » No-brow design increases upward peripheral vision and limits interference with hard hat suspension systems
- » Meets ANSI Z87.1+ standards; TAA compliant
- » Provides 99.9% UVA/UVB/UVC protection

ITEM #	ORDER #	DESCRIPTION	UOM
25704	C24120741	Smoke Lens, Gunmetal Temples	EA
29111	C24120731	Clear Anti-Fog Lens, Gunmetal Temples	EA
20470	C24120721	Clear Hardcoated Lens, Gunmetal Temples	EA



KleenGuard™ OTG* SAFETY GLASSES

- » Anti-fog lens coating
- » See-through side shields provide side impact protection without blocking peripheral vision
- » Features an hard coating to prevent lens damage
- » Meets ANSI Z87.1+ standards for high impact and polycarbonate lenses provide 99.9% UVA/UVB/UVC protection

ITEM #	ORDER #	DESCRIPTION	UOM
20746	C24123851	Clear Anti-Fog Lens, Black Frame	EA
20747	C24123861	Smoke Anti-Fog Lens, Black Frame	EA



Glasses



21302



Smith & Wesson® Elite* Safety Glasses

- » Anti-scratch, dual lens offers wrap-around protection, and the wide temple provides stability
- » Meets ANSI Z87.1+ standards
- » Lightweight lenses provide 99.9% UVA/UVB/UVC protection
- » Glasses come with a Smith & Wesson branded microfiber carry bag that doubles as a cleaning cloth

ITEM #	ORDER #	DESCRIPTION	UOM
21302	C24163121	Clear Anti-Fog Lens, Black Frame	EA
21303	C24163131	Smoke Lens, Black Frame	EA
21306	C24163151	Indoor/Outdoor Lens, Black Frame	EA



21296



Smith & Wesson® Equalizer* Safety Glasses

- » Sport grip temples help reduce slippage
- » Dual lenses offer wraparound protection
- » Flexible rubber nose pads for comfort and fit
- » Meets ANSI Z87.1+ standards
- » Anti-scratch polycarbonate lenses and provide 99.9% UVA/UVB/UVC protection
- » Glasses come with a Smith & Wesson branded microfiber carry bag that doubles as a cleaning cloth

ITEM #	ORDER #	DESCRIPTION	UOM
21296	C24163071	Clear Anti-Fog Lens, Gunmetal Frame	EA
21297	C24163081	Smoke Anti-Fog Lens, Gunmetal Frame	EA



19826



Smith & Wesson® Magnum 3G* Safety Glasses

- » Ergonomically dimensioned three-point extendable temples – so you can adjust to fit
- » Self-adjusting nose pad with rubber fingers prevent glasses from slipping down the nose
- » Cut-to-shape lens provides less distortion
- » Meets ANSI Z87.1+ standards
- » Lightweight polycarbonate lenses that provide 99.9% UVA/UVB/UVC protection

ITEM #	ORDER #	DESCRIPTION	UOM
19794	C24121331	Clear Anti-Fog Lens, Black Frame	EA
19796	C24121341	Copper Blue Block Lens, Black Frame	EA
19799	C24121351	Clear Lens, Black Frame	EA
19823	C24121371	Smoke Lens, Black Frame	EA
19826	C24121391	Yellow Lens, Black Frame	EA



19856



Smith & Wesson® 38 Special* Safety Glasses

- » Ergonomically designed temples with rubber insert tips for a soft, secure, snug fit
- » Hardcoated lenses for scratch resistance and longevity
- » Meets the "High Impact" level of the ANSI Z87.1+ standards and are TAA compliant
- » Lenses provide 99.9% UVA/UVB/UVC protection

ITEM #	ORDER #	DESCRIPTION	UOM
19856	C24121561	Clear Lens, Black Frame	EA
19859	C24121591	Smoke Lens, Black Frame	EA



Glasses



BK112

BearKat® Safety Glasses

- » Single lens design with integral side shields for unobstructed view
- » Non-slip soft black temple material
- » Exclusive Duramass® scratch resistant coating
- » Rugged polycarbonate lens filters 99.9% of harmful U.V. rays
- » Meets ANSI Z87+ and CSA Z94.3

ITEM #	ORDER #	DESCRIPTION	UOM
BK110	331401111	Clear Lens, Clear Temple	EA
BK110AF	331400211	Clear Anti-Fog Lens, Clear Temple	EA
BK112	331400221	Gray Lens, Gray Temple	EA
BK112AF	331400231	Gray Anti-Fog Lens, Gray Temple	EA
BK113	331400241	Light Blue Lens, Light Blue Temple (Not CSA Z94 Tested)	EA
BK114	331401141	Amber Lens, Amber Temple	EA
BK117	331411171	Silver Mirror Lens, Smoke Temple	EA
BK118	331400251	Blue Mirror Lens, Smoke Temple	EA
BK119	331411191	Indoor/Outdoor Mirror Lens, Smoke Temple	EA



S2110

Blackjack® Safety Glasses

- » Rimless design for unobstructed vision
- » Fully adjustable metal alloy hybrid temples
- » Non-slip, soft temple material, universal nose bridge
- » Exclusive Duramass® scratch resistant coating
- » Rugged polycarbonate lens filters 99.9% of harmful U.V. rays
- » Meets ANSI Z87+

ITEM #	ORDER #	DESCRIPTION	UOM
S2110	331421111	Clear Lens, Chrome Metal Temple	EA
S2110AF	331403111	Clear lens Anti-Fog Lens, Chrome Metal Temple	EA
S2112AF	331403131	Gray Lens, Chrome Metal Temple	EA



BD110PF

Backdraft® Safety Glasses

- » Contoured frameless with internal TPR side shields
- » Dielectric, no metal parts
- » Secure TPR nose pad and temple sleeves
- » Anti-fog lenses filters 99.9% U.V. harmful rays
- » MAX6™ Premium Anti-fog coating
- » 6x greater fog protection
- » Meets ANSI Z87+

ITEM #	ORDER #	DESCRIPTION	UOM
BD110PF	331441891	Clear Lens, Black Frame	EA
BD112PF	331442391	Gray Lens, Black Frame	EA



IA128B

Inertia® Safety Glasses

- » Unique Flarefit™ temple design
- » Rugged polycarbonate lens filters 99.9% of harmful U.V. rays
- » Non-slip wrap around TPR temple sleeve
- » Soft, secure TPR nose pads
- » Exclusive Duramass® scratch resistant coating
- » Dielectric (no metal parts), meets ANSI Z87+

ITEM #	ORDER #	DESCRIPTION	UOM
IA120AF	331439201	Clear Anti-Fog Lens, Silver Temple	EA
IA128B	331438761	Blue Mirror Lens, Silver Temple	EA
IA130AF	331439071	Clear Anti-Fog Lens, White Temple	EA
IA132AF	331468141	Gray Anti-Fog Lens, White Temple	EA



Glasses



CL010

Checklite® Safety Glasses

- » Good for everyday use or for a visitor
- » Smaller frame sized to fit smaller faces
- » Rugged polycarbonate lens filters 99.9% of harmful U.V. rays
- » Meets ANSI Z87+ and CSA Z94.3

ITEM #	ORDER #	DESCRIPTION	UOM
CL010	331400461	Clear Uncoated Lens, Clear Temple	EA
CL110	331400471	Clear Anti-Scratch Lens, Clear Temple	EA
CL110AF	331400481	Clear Anti-Scratch Anti-Fog Lens, Clear Temple	EA
CL112	331400491	Gray Anti-Scratch Lens, Smoke Temple	EA
CL119	331400511	I/O Mirror Anti-Scratch Lens, Clear Temple	EA



CK112

CheckMate® Safety Glasses

- » Polycarbonate lens provides near total orbital seal
- » Flexible bayonet temples
- » Rugged polycarbonate lens filters 99.9% of harmful U.V. rays
- » Meets ANSI Z87+

ITEM #	ORDER #	DESCRIPTION	UOM
CK100	331400271	Clear Uncoated Lens, Clear Temple	EA
CK110	331401101	Clear Anti-Scratch Lens, Clear Temple	EA
CK110AF	331400281	Clear Anti-Scratch Anti-Fog Lens, Clear Temple	EA
CK112	331401121	Gray Anti-Scratch Lens, Smoke Temple	EA



CK210

CK2® Safety Glasses

- » Polycarbonate lens provides near total orbital seal
- » Flexible bayonet temple with non-slip, soft gel temple material
- » Exclusive Duramass® scratch resistant coating
- » Rugged polycarbonate lens filters 99.9% of harmful U.V. rays
- » Meets ANSI Z87+

ITEM #	ORDER #	DESCRIPTION	UOM
CK210	331412101	Clear Lens, Smoke Temple	EA
CK210AF	331400331	Clear Anti-Fog Lens, Smoke Temple	EA



KD120

Klondike® Safety Glasses

- » Full orbital seal with dual lens design
- » Soft secure TPR nose pad
- » Extendable spatula temples
- » Exclusive Duramass® scratch resistant coating
- » Lens filters 99.9% of harmful U.V. rays
- » Meets ANSI Z87+ and CSA Z94.3

ITEM #	ORDER #	DESCRIPTION	UOM
KD110	331432011	Clear Lens, Matte Black Frame	EA
KD110AF	331402101	Clear Anti-Fog Lens, Matte Black Frame	EA
KD112	331401541	Gray Lens, Matte Black Frame	EA
KD120	331402121	Clear Lens, Matte Blue Frame (Not CSA Tested)	EA



Glasses



T411G

Rubicon® Safety Glasses

- » Curved frameless lens design offering close orbital seal
- » Spring hinge metal temples with non-slip temple sleeves
- » Soft gel nose piece
- » Duramass® scratch resistant coating
- » Rugged polycarbonate lens filters 99.9% of harmful U.V. rays
- » Meets ANSI Z87+

ITEM #	ORDER #	DESCRIPTION	UOM
T4110AF	331404131	Clear Anti-Fog Lens, Gray Metal Temple	EA
T4112AF	331404141	Gray Anti-Fog Lens, Gray Metal Temple	EA
T4113AF	331404151	Light Blue Anti-Fog Lens, Gray Metal Temple	EA
T411R	331404121	Fire Mirror Lens, Gray Metal Temple	EA
T411G	331404111	Emerald Mirror Lens, Gray Metal Temple	EA



ST1130

Storm® Safety Glasses

- » Single wraparound dual focal point lens with integral side shields
- » 5 position ratchet action bayonet temples
- » Exclusive Duramass® scratch resistant coating
- » Non-slip, soft temple material
- » Rugged polycarbonate lens filters 99.9% of harmful U.V. rays
- » Meets ANSI Z87+ and CSA Z94.3

ITEM #	ORDER #	DESCRIPTION	UOM
ST110	331464051	Clear Lens, Black Frame	EA
ST1130	331403011	3.0 Shade Filter, Black Frame	EA
ST1150	331403031	5.0 Shade Filter, Black Frame (Not CSA Tested)	EA



OG110AF



Law® Over-the-Glass Safety Glasses

- » Oversized frame and lens to fit over prescription glasses
- » 5 position ratchet action temple allows lens angle adjustment
- » Exclusive Duramass® scratch resistant coating
- » Rugged polycarbonate lens filters 99.9% of harmful U.V. rays
- » Dielectric (no metal parts), meets ANSI Z87+ and CSA Z94.3

ITEM #	ORDER #	DESCRIPTION	UOM
OG110AF	331440181	Clear Anti-Fog Lens, Silver Temple	EA
OG112AF	331439811	Gray Anti-Fog Lens, Silver Temple	EA



SS110

Stratos® Safety Glasses

- » Single lens design, integral side shields offer protection
- » Spatula temple with extendable adjustment
- » Rugged polycarbonate lens filters 99.9% of harmful U.V. rays
- » Meets ANSI Z87+

ITEM #	ORDER #	DESCRIPTION	UOM
SS010	331402921	Clear Uncoated Lens, Black Frame	EA
SS110	331441101	Clear Duramass® Scratch Resistant Coated Lens, Black Frame	EA



Glasses



Swagger® Safety Glasses

- » Non-slip co-injected soft temple material
- » Wider temples for better side protection
- » Soft secure TPR nose pad
- » Exclusive Duramass® scratch resistant coating
- » Rugged polycarbonate lens filters 99.9% of harmful U.V. rays
- » Meets ANSI Z87+



SR11R



SR128B

ITEM #	ORDER #	DESCRIPTION	UOM
SR11R	331440951	Fire Mirror Lens, Black Frame	EA
SR13R	331440981	Fire Mirror Lens, Red Frame	EA
SR118B	331440881	Blue Diamond Mirror, Black Frame	EA
SR120	331440891	Clear Lens, White Frame	EA
SR122AF	331451021	Gray Anti-Fog Lens, White Frame	EA
SR128B	331440911	Blue Diamond Mirror, White Frame	EA
SR137	331440971	Silver Mirror Lens, Red Frame	EA



HK117

HellKat® Safety Glasses

- » Soft, secure TPR nose pad
- » Non-slip soft temple material
- » Excellent orbital seal for eye protection
- » Meets ANSI Z87+

ITEM #	ORDER #	DESCRIPTION	UOM
HK110AF	331407651	Clear Anti-fog Lens, Clear Frame	EA
HK112AF	331406861	Gray Anti-fog Lens, Gray Frame	EA
HK117	331443641	Silver Mirror Lens, Gray Frame	EA



TK120

Tomahawk® Safety Glasses

- » High brow guard for extra protection
- » Single lens design with integral side shields for greater orbital seal
- » Spatula temple with extendable adjustment
- » Exclusive Duramass® scratch resistant coating
- » Rugged polycarbonate lens filters 99.9% of harmful U.V. rays
- » Meets ANSI Z87+

ITEM #	ORDER #	DESCRIPTION	UOM
TK110	331464011	Clear Lens, Black Frame	EA
TK112	331403541	Gray Lens, Black Frame	EA
TK120	331464021	Clear Lens, Blue Frame	EA



Yukon® Visitor Safety Glasses

- » Dielectric, no metal parts
- » Single lens design with integral side shields for greater orbital seal
- » Spatula temples
- » Rugged polycarbonate lens filters 99.9% of harmful U.V. rays
- » ANSI Z87+ and CSA Z94.3



9800

ITEM #	ORDER #	DESCRIPTION	UOM
9800	331405321	Clear Uncoated Lens, Clear Frame	EA



Glasses



DeWALT® DPG52 ContraWctor Pro™ Safety Glasses

- » Rubber-tipped temples and soft, rubber nosepiece
- » Hard coat and distortion free lens with 99.9% UVA/UVB protection
- » Impact resistant polycarbonate lens meets ANSI Z87.1+ standards



DPG52-1D

ITEM #	ORDER #	DESCRIPTION	UOM
DPG52-1D	336535731	Clear Lens, Clear Frame	EA
DPG52-2D	336535751	Smoke Lens, Smoke Frame	EA
DPG52-6D	336535761	Silver/Mirror Lens, Smoke Frame	EA



DeWALT® DPG54 Protector™ Safety Glasses

- » Ergonomic, lightweight design weighs less than 1 oz.
- » Rubber-tipped temples
- » Hard coat and distortion free lens with 99.9% UVA/UVB protection
- » Impact resistant polycarbonate lens meets ANSI Z87.1+ standards



DPG54-1D

ITEM #	ORDER #	DESCRIPTION	UOM
DPG54-1D	336535791	Clear Lens, Yellow Temple	EA
DPG54-2D	336535811	Smoke Lens, Yellow Temple	EA



Mirage™ Safety Eyewear

- » Dielectric snap fit temples
- » Optically correct and distortion free lenses
- » Dual wraparound 9.75 base lens provides orbital seal
- » Impact resistance polycarbonate lens
- » Safety glass meets ANSI Z87.1+



MR0110ID

ITEM #	ORDER #	DESCRIPTION	UOM
MR0110ID	336531751	Clear Lens, Clear Frame	EA
MR0111ID	336531761	Clear Anti-Fog Lens, Clear Frame	EA
MR0120ID	336531771	Smoke Lens, Smoke Frame	EA
MR0121ID	336531781	Smoke Anti-Fog Lens, Smoke Frame	EA
MR0190ID	336531791	Indoor/Outdoor Lens, Indoor/Outdoor Frame	EA



Rad-Sequel™ Safety Eyewear

- » Rubber tipped temples provide a secure fit
- » Soft, rubber nose piece provides comfort
- » Polycarbonate lens provides impact resistance
- » Protective lens provide 99.9% UVA/UVB protection
- » Safety glasses meet ANSI Z87.1+ standards



RS1-10

ITEM #	ORDER #	DESCRIPTION	UOM
RS1-10	336531461	Clear Lens, Clear Frame	EA
RS1-11	336531471	Clear Anti-Fog Lens, Clear Frame	EA
RS1-20	336531481	Smoke Lens, Smoke Frame	EA



Glasses



542-0201



GTR Safety Glasses

- » Scratch-resistant, anti-fog lens
- » Wraparound design with non-slip rubber nose piece and temples
- » High-impact polycarbonate lens
- » 99.9% UV Protection
- » Meets ANSI Z87.1-2015

ITEM #	ORDER #	DESCRIPTION	UOM
542-0201	G73502021	Shade Lens, Silver Frame	EA
542-0200	G73522811	Clear Lens, Silver Frame	EA

WARNING: Cancer and Reproductive Harm - www.P65Warnings.ca.gov



5340

5343



NSX™ Safety Glasses

- » Anti-fog and scratch resistant coating on lenses
- » Lightweight wrap-around single lens design
- » High-impact polycarbonate lenses
- » 99.9% UV Protection
- » Meets ANSI Z87.1-2015

ITEM #	ORDER #	DESCRIPTION	UOM
5340	G73553401	Clear Lens, Black Temples	EA
5341	G73553411	Yellow Lens, Black Temples	EA
5342	G73553421	Orange Lens, Black Temples	EA
5343	G73553431	Gray Lens, Black Temples	EA
5344	G73553441	Gold Mirror Lens, Black Temples	EA
5346	G73553461	Shade 5.0 Lens, Black Temples	EA

Visitor, High Impact Lens, No Lens Coatings

5347-00	G7358004	Clear Lens, Clear Frame	100/CS
---------	----------	-------------------------	--------

WARNING: Cancer and Reproductive Harm - www.P65Warnings.ca.gov



540-0200



Diamondbacks™ Safety Glasses

- » Anti-fog and scratch resistant coating on lenses
- » Wrap-around design hugs the face
- » Non-slip nose piece and temples
- » High-impact polycarbonate lenses
- » 99.9% UV Protection
- » Meets ANSI Z87.1-2015

ITEM #	ORDER #	DESCRIPTION	UOM
540-0200	G73502001	Clear Lens, Black Frame	EA
540-0203	G73502031	Smoke Mirror Lens, Black Frame	EA

WARNING: Cancer and Reproductive Harm - www.P65Warnings.ca.gov



5333



NSX™ Turbo Safety Glasses

- » Scratch resistant coating on lenses
- » Lightweight, mono wrap-around lens design
- » Non-slip black temple ends
- » High-impact polycarbonate lenses
- » 99.9% UV Protection
- » Meets ANSI Z87.1-2015

ITEM #	ORDER #	DESCRIPTION	UOM
5330	G73553301	Clear Lens, Clear Temples	EA
5331	G73553311	Gray Lens, Gray Temples	EA
5332	G73553321	Yellow Lens, Yellow Temples	EA
5333	G73553331	Light Blue Lens, Light Blue Temples	EA
5334	G73553341	I/O Mirror Lens, I/O Temples	EA

WARNING: Cancer and Reproductive Harm - www.P65Warnings.ca.gov



Glasses



468M

StarLite® Safety Glasses

- » Lightweight, weighs less than 1 oz.
- » Dual 9.75 base curvature viewing areas for wide vision
- » Independently tested and certified by UL® to meet CSA Z94.3, ANSI Z87+ and ballistics MIL-PRF-32432 (GL)
- » Scratch-resistant, 100% polycarbonate lenses block 99.9% of UV-A, UV-B and UV-C light, up to 380 nm

ITEM #	ORDER #	DESCRIPTION	UOM
4675	323346751	Amber Lens, Amber Temple	EA
4678	323346781	Gray Anti-Fog Lens, Gray Temple	EA
4679	323346791	Clear Anti-Fog Lens, Clear Temple	EA
4680	323346801	Clear Lens, Clear Temple	EA
4683	323346831	Gray Lens, Gray Temple	EA
460M	323304601	Clear Indoor/Outdoor Mirror Lens, Clear Temple	EA
468M	323300481	Silver Mirror Lens, Gray Temple	EA
469M	323300501	Blue Mirror Lens, Gray Temple	EA



4476

StarLite® SQUARED Safety Glasses

- » Lightweight, weighs less than 1 oz.
- » Soft, pliable temples and a fingertip nosepiece offer comfort for users
- » Snug and comfortable fit; minimize slippage and provides full brow protection
- » Independently tested and certified by UL® to meet CSA Z94.3, ANSI Z87+ and ballistics MIL-PRF-32432 (GL)
- » Scratch-resistant, 100% polycarbonate lenses block 99.9% of UV-A, UV-B and UV-C light, up to 380 nm

ITEM #	ORDER #	DESCRIPTION	UOM
4476	323300391	Pacific Blue Lens, Blue Temple	EA
4479	323300401	Clear Anti-Fog Lens, Clear Temple	EA
4480	323300421	Clear Lens, Clear Temple	EA
4483	323300431	Gray Lens, Gray Temple	EA
440M	323300371	Clear Indoor/Outdoor Mirror Lens, Clear Temple	EA
448M	323300411	Silver Mirror Lens, Gray Temple	EA



Tryon and Tryon OTG Safety Glasses

- » Wrap-around frame
- » Adjustable non-slip bridge
- » Platinum® anti-fog/anti-scratch coating options
- » PC/TPR co-injected temples
- » ANSI Z87.1-2010 and CSA Z94.7-2007 compliant



40304



40306

ITEM #	ORDER #	DESCRIPTION	UOM
40301	J59201111	Black/Blue Frame - Clear Anti-Fog/Anti-Scratch Lens Coating	EA
40302	J59201121	Black/Blue Frame - Smoke Anti-Fog/Anti-Scratch Lens Coating	EA
40305	J59201141	Black/Blue Frame - CSP Anti-Fog/Anti-Scratch Lens Coating (Absorbs 52% of Blue Light)	EA
40304	J59201131	Black/Blue Frame - Blue Flash Anti-Scratch Lens Coating	EA
40306	J59201151	OTG - Black/Blue Frame - ClearAnti-Fog/Anti-Scratch Lens Coating	EA

WARNING: Cancer and Reproductive Harm - www.P65Warnings.ca.gov



Glasses



Rush+ Safety Glasses

- » Upper protection
- » Platinum® anti-fog/anti-scratch coating
- » Co-injected, ultra-flex temples
- » Non-slip adjustable bridge
- » 99.99% UVA and UVB light absorption
- » Weighs 26 grams and comes with microfiber pouch
- » ANSI Z87.1-2010 compliant



40225



40249

ITEM #	ORDER #	DESCRIPTION	UOM
40208	J59200321	Black/Gray Temples - Smoke Anti-Fog/Anti-Scratch Lens Coating	EA
40209	J59200331	Black/Gray Temples - CSP Anti-Fog/Anti-Scratch Lens Coating	EA
40225	J59200341	Black/Gray Temples - Twilight Anti-Fog/Anti-Scratch Lens Coating	EA
41080	J59200361	Red/Black Temples - Clear Anti-Fog/Anti-Scratch Lens Coating	EA
40256	J59201081	Blue/Green Temples - Clear Anti-Fog/Anti-Scratch Lens Coating	EA

Small

40250	J59200371	Yellow/Black Temples - Clear Anti-Fog/Anti-Scratch Lens Coating	EA
40253	J59200381	Yellow/Black Temples - Smoke Anti-Fog/Anti-Scratch Lens Coating	EA
40254	J59200391	Pink/White Temples - Clear Anti-Fog/Anti-Scratch Lens Coating	EA
40249	J59200401	Pink/White Temples - CSP Anti-Fog/Anti-Scratch Lens Coating	EA

Accessory

40293	J59200351	Foam and Strap Kit	EA
-------	-----------	--------------------	----

WARNING: Cancer and Reproductive Harm - www.P65Warnings.ca.gov



Rush Safety Glasses

- » Upper protection
- » Adjustable non-slip bridge
- » Non-slip temples
- » Anti-scratch coating, 99.99% UVA and UVB light absorption
- » Weighs 25 grams and includes adjustable cord
- » ANSI Z87.1-2010 and CSA Z94.3-2007 compliant



40072

ITEM #	ORDER #	DESCRIPTION	UOM
40070	J59200271	Clear Temples - Clear Anti-Fog/Anti-Scratch Lens Coating	EA
40071	J59200281	Smoke Temples - Smoke Anti-Fog/Anti-Scratch Lens Coating	EA
40072	J59200291	Twilight Temples - Twilight Anti-Fog/Anti-Scratch Lens Coating	EA
40113	J59200311	Clear HD Hydrophobic Lens Coating	EA

Accessory

40193	J59200301	Foam Kit	EA
-------	-----------	----------	----

WARNING: Cancer and Reproductive Harm - www.P65Warnings.ca.gov



Contour Safety Glasses

- » Adjustable nose pads
- » Non-slip TIPGRIP temples
- » Anti-scratch coating, 99.99% UVA and UVB light absorption
- » Lightweight, weighs 21 grams, comes with microfiber pouch and adjustable cord
- » ANSI Z87.1-2010 and CSA Z94.3-2007 compliant



40045

ITEM #	ORDER #	DESCRIPTION	UOM
40044	J59200111	Dark Gunmetal Frame - Anti-Fog/Anti-Scratch Lens Coating	EA
40045	J59200121	Dark Gunmetal Frame - Anti-Fog/Anti-Scratch Lens Coating	EA
40047	J59200131	Dark Gunmetal Frame - ESP Anti-Fog/Anti-Scratch Lens Coating (Absorbs 62% of Blue Light)	EA
40048	J59200141	Dark Gunmetal Temples - Polarized Smoke Anti-Scratch Coating	EA

WARNING: Cancer and Reproductive Harm - www.P65Warnings.ca.gov



Glasses



bolle
SAFETY

40278

Baxter Safety Glasses/Goggles

- » Rated D3/D4/D5 for protection from liquid splash, dust and fine dust
- » Increased peripheral protection
- » Wrap-around frame
- » Waterproof foam and removable strap
- » Platinum® anti-fog/anti-scratch coating
- » Weighs 48.8 grams
- » ANSI Z87.1-2010 and CSA Z94.7-2007 compliant

ITEM #	ORDER #	DESCRIPTION	UOM
40276	J59200011	Black/Blue Frame - Clear Anti-Fog/ Anti-Scratch Lens Coating	EA
40277	J59200021	Black/Blue Frame - Smoke Anti-Fog/ Anti-Scratch Lens Coating	EA
40278	J59200031	Black/Blue Frame - CSP Anti-Fog/ Anti-Scratch Lens Coating (Absorbs 52% of Blue Light)	EA

WARNING: Cancer and Reproductive Harm - www.P65Warnings.ca.gov



bolle
SAFETY

40151

Hustler Safety Glasses

- » Integrated side shields
- » Non-slip bridge and temples
- » Anti-scratch coating, 99.99% UVA and UVB light absorption
- » Weighs 25 grams, comes with microfiber pouch and adjustable cord
- » ANSI Z87.1-2010 and CSA Z94.3-2007 compliant

ITEM #	ORDER #	DESCRIPTION	UOM
40149	J59200151	Shiny Black - Smoke Lens Anti-Fog/ Anti-Scratch Lens Coating	EA
40150	J59200161	Shiny Black - Polarized Smoke Lens Anti-Fog/Anti-Scratch Lens Coating	EA
40151	J59200171	Shiny Black - Polarized Blue Mirror Anti-Fog Inside Lens/Anti-Scratch Outside Lens	EA

WARNING: Cancer and Reproductive Harm - www.P65Warnings.ca.gov



bolle
SAFETY

40182

IRI-S Safety Glasses

- » High contour (9 base), single piece lens with 180° distortion free viewing
- » Platinum® anti-fog/anti-scratch coating
- » B-Flex nose and memory shape bridge
- » 99.99% UVA and UVB light absorption
- » Weighs 27 grams, comes with microfiber pouch and adjustable cord
- » ANSI Z87.1-2010 compliant

ITEM #	ORDER #	DESCRIPTION	UOM
40120	J59200181	Black/Grey Temples - Twilight Anti-Fog/Anti-Scratch Lens Coating	EA
40182	J59200191	Black/Grey Temples - Smoke Anti-Fog/Anti-Scratch Lens Coating	EA

WARNING: Cancer and Reproductive Harm - www.P65Warnings.ca.gov



bolle
SAFETY

40057

Prism Safety Glasses

- » High contour (9 base), single piece lens with 180° distortion free viewing
- » Dielectric, non-conductive frame
- » Anti-fog/anti-scratch lens coating, 99.99% UVA and UVB light absorption
- » Weighs 23 grams, comes with adjustable cord
- » ANSI Z87.1-2010 and CSA Z94.3-2007 compliant

ITEM #	ORDER #	DESCRIPTION	UOM
40057	J59200231	Black Temples - Clear Anti-Fog/ Anti-Scratch Lens Coating	EA
40058	J59200241	Black Temples - Smoke Anti-Fog/ Anti-Scratch Lens Coating	EA
40059	J59200251	Black Temples - Silver Flash Mirror Anti-Scratch Lens Coating	EA

Accessory

ITEM #	ORDER #	DESCRIPTION	UOM
40194	J59200261	Foam Kit	EA

WARNING: Cancer and Reproductive Harm - www.P65Warnings.ca.gov



Glasses



Cobra Safety Glasses

- » Upper protection
- » Adjustable non-slip bridge
- » Non-slip temples
- » Anti-fog/anti-scratch lens coating, 99.99% UVA and UVB light absorption
- » Weighs 25 grams and includes adjustable cord
- » ANSI Z87.1-2010 and CSA Z94.3-2007 compliant



40041



40043

ITEM #	ORDER #	DESCRIPTION	UOM
40037	J59200041	Black Temples - Anti-Fog/Anti-Scratch Lens Coating	EA
40038	J59200051	Black Temples - Anti-Fog/Anti-Scratch Lens Coating	EA
40040	J59200061	Black Temples - Clear HD Hydrophobic Lens Coating	EA
40041	J59200071	Black Temples - Contrast Anti-Fog/Anti-Scratch Lens Coating	EA
40042	J59200081	Black Temples - ESP Anti-Fog/Anti-Scratch Lens Coating (Absorbs 62% of Blue Light)	EA
40112	J59200101	Black Temples - Twilight Anti-Fog/Anti-Scratch Lens Coating	EA

Accessory Kit to Convert into Goggles

40043	J59200091	Cobra Strap and Foam Padding Goggle Kit	EA
-------	-----------	---	----

⚠ WARNING: Cancer and Reproductive Harm - www.P65Warnings.ca.gov



Shadow Safety Glasses

- » High impact 2.00 mm polycarbonate lens
- » Close fitting, high contour (8 base) dual lens design
- » Non-slip rubber nose pad, rubber temple tips for non-slip grip
- » Anti-fog/anti-scratch lens coatings, 99.99% UVA and UVB light absorption
- » Weighs 23 grams, comes with adjustable cord
- » ANSI Z87.1-2010 and CSA Z94.3-2007 compliant



40159

ITEM #	ORDER #	DESCRIPTION	UOM
40060	J59200411	Shiny Black - Smoke Anti-Fog/Anti-Scratch Lens Coating	EA
40061	J59200421	Shiny Black - Polarized Smoke Anti-Fog/Anti-Scratch Lens Coating	EA
40159	J59200431	Shiny Black - Red Flash Mirror Anti-Scratch Lens Coating	EA

⚠ WARNING: Cancer and Reproductive Harm - www.P65Warnings.ca.gov



Tracker Safety Glasses/Goggles

- » Upper and lower protection
- » Removable foam reinforcement with indirect ventilation
- » Removable adjustable strap
- » Side ventilation
- » Anti-fog/anti-scratch lens coating, 99.99% UVA and UVB light absorption
- » Weighs 52 grams, comes with microfiber pouch and adjustable cord
- » ANSI Z87.1-2010 and CSA Z94.3-2007 compliant



40089

ITEM #	ORDER #	DESCRIPTION	UOM
40085	J59200491	Black/Gray Temples - Clear Anti-Fog/Anti-Scratch Lens Coating	EA
40088	J59200501	Black/Gray Temples - Twilight Anti-Fog/Anti-Scratch Lens Coating	EA
40089	J59200511	Black/Gray Temples - Welding Shade 5 Polycarbonate Lens	EA

⚠ WARNING: Cancer and Reproductive Harm - www.P65Warnings.ca.gov



Glasses



bolle
SAFETY

Silium+ Safety Glasses

- » Ultra-lightweight frame with close fitting, high contour (9 base) dual lens
- » Non-slip bridge
- » Ergonomic flexible temples
- » Platinum® anti-fog/anti-scratch coating, 99.99% UVA and UVB light absorption
- » Weighs 34 grams, comes with microfiber pouch and adjustable cord
- » ANSI Z87.1-2010 and CSA Z94.3-2007 compliant

ITEM #	ORDER #	DESCRIPTION	UOM
40238	J59200441	Gunmetal - Smoke Anti-Fog/ Anti-Scratch Lens Coating	EA
40239	J59200451	Gunmetal - CSP Anti-Fog/ Anti-Scratch Lens Coating (Absorbs 53% of Blue Light)	EA

WARNING: Cancer and Reproductive Harm - www.P65Warnings.ca.gov



bolle
SAFETY

Voodoo Safety Glasses

- » Close fitting (8) base, high impact polycarbonate dual lens
- » Integrated side shields
- » Non-slip rubber nose pads and temples
- » Anti-fog/anti-scratch lens coating, 99.99% UVA and UVB light absorption
- » Weighs 29 grams, comes with microfiber pouch and adjustable cord
- » ANSI Z87.1-2010 and CSA Z94.3-2007 compliant

ITEM #	ORDER #	DESCRIPTION	UOM
40152	J59200521	Black Frame - Smoke Anti-Fog/ Anti-Scratch Lens Coating	EA
40153	J59200531	Brown Frame - Polarized Brown Anti-Scratch Lens Coating	EA

WARNING: Cancer and Reproductive Harm - www.P65Warnings.ca.gov



bolle
SAFETY

Lowrider Safety Glasses

- » High impact polycarbonate lens
- » Low-profile, 8 base wraparound frame
- » Non-slip rubber nose pads and temples
- » Anti-fog/anti-scratch lens coating, 99.99% UVA and UVB light absorption
- » Weighs 30 grams, comes with microfiber pouch and adjustable cord
- » ANSI Z87.1-2010 and CSA Z94.3-2007 compliant

ITEM #	ORDER #	DESCRIPTION	UOM
40052	J59200201	Shiny Black - Smoke Anti-Fog/ Anti-Scratch Lens Coating	EA
40053	J59200211	Shiny Black - Polarized Smoke Anti- Scratch Lens Coating	EA
40156	J59200221	Shiny Black - Blue Mirror Anti-Scratch Lens Coating	EA

WARNING: Cancer and Reproductive Harm - www.P65Warnings.ca.gov



bolle
SAFETY

Solis Safety Glasses

- » Close fitting (8) base, high impact polycarbonate dual lens
- » Lightweight nylon non-slip frame
- » Rubber nose pads
- » Anti-scratch coating, 99.99% UVA and UVB light absorption
- » Weighs 25 grams, comes with microfiber pouch and adjustable cord
- » ANSI Z87.1-2010 and CSA Z94.3-2007 compliant

ITEM #	ORDER #	DESCRIPTION	UOM
40063	J59200461	Shiny Black - Smoke Anti-Fog/ Anti-Scratch Lens Coating	EA
40064	J59200471	Shiny Black - Blue Flash Mirror Anti- Scratch Lens Coating	EA
40065	J59200481	Shiny Black - Polarized Gray Anti-Scratch Lens Coating	EA

WARNING: Cancer and Reproductive Harm - www.P65Warnings.ca.gov



Glasses



3M™ BX™ Readers Safety Eyewear

- » Molded-in magnifying diopters
- » Lightweight lenses with adjustable soft tip adjustable temples and integrated sideshields
- » Soft nose bridge, lens angle adjustment
- » Anti-fog impact-resistant polycarbonate lenses absorb 99.99% UV rays
- » Meet the requirements of CSA Z94.3-2007 and ANSI Z87.1-2010



11377-00000-20

ITEM #	ORDER #	DESCRIPTION	UOM
11374-00000-20	665570241	Clear +1.5 Diopter Lens, Silver/Black Frame	EA
11375-00000-20	665520811	Clear +2.0 Diopter Lens, Silver/Black Frame	EA
11376-00000-20	665564091	Clear +2.5 Diopter Lens, Silver/Black Frame	EA
11377-00000-20	665522521	Gray +1.5 Diopter Lens, Silver/Black Frame	EA
11378-00000-20	665522001	Gray +2.0 Diopter Lens, Silver/Black Frame	EA
11379-00000-20	665522711	Gray +2.5 Diopter Lens, Silver/Black Frame	EA



3M™ Nuvo™ Readers Safety Eyewear

- » Molded-in magnifying diopters
- » Adjustable soft tip adjustable temples
- » Integral brow bar and side shields offer protection
- » Soft adjustable nose bridge
- » Anti-fog impact-resistant polycarbonate lenses absorb 99.99% UV rays
- » Meet the requirements of ANSI Z87.1-2003, CSA Z94.3-2007



11434-00000-20

ITEM #	ORDER #	DESCRIPTION	UOM
11434-00000-20	665563881	Clear +1.5 Diopter Lens, Gray Frame	EA
11435-00000-20	665574221	Clear +2.0 Diopter Lens, Gray Frame	EA
11436-00000-20	665574231	Clear +2.5 Diopter Lens, Gray Frame	EA



3M™ SecureFit™ Safety Readers

- » 3M™ Pressure Diffusion Technology allows temples to adjust to individual head sizes
- » Lightweight, comfortable protection, weighs less than 1 oz.
- » Rubber temple tips
- » Soft rubber nose bridge
- » Anti-fog impact-resistant polycarbonate lenses absorb 99.99% UV rays
- » Meet the requirements of CSA Z94.3-2007 and ANSI Z87.1-2010



SF415AF

ITEM #	ORDER #	DESCRIPTION	UOM
SF415AF	665534561	Clear +1.5 Diopter Lens, Black Temples	EA
SF420AF	665534571	Clear +2.0 Diopter Lens, Black Temples	EA



Readers



DeWALT® DPG59 Reinforcer Rx™ Safety Glasses

- » Combines safety glasses with a reading glass, magnification diopter molded into lens
- » Black frames, rubber-tipped temple pads and soft, rubber nosepiece
- » Hard coat and distortion free lens with 99.9% UVA/UVB protection
- » Impact resistant polycarbonate lens meets ANSI Z87.1+ standards

ITEM #	ORDER #	DESCRIPTION	UOM
DPG59-110	336536011	Clear Lens, Rx-Bifocal +1.0	EA
DPG59-115	336536021	Clear Lens, Rx-Bifocal +1.5	EA
DPG59-120	336536031	Clear Lens, Rx-Bifocal +2.0	EA
DPG59-125	336536041	Clear Lens, Rx-Bifocal +2.5	EA
DPG59-130	336536051	Clear Lens, Rx-Bifocal +3.0	EA



DPG59-130



Uvex Genesis® Readers

- » Dual 9-base wrap-around lens provides peripheral vision and protection
- » Soft brow guard absorbs and diffuses impact
- » Adjustable temple length and ratcheting lens
- » Padded adjustable temples, flexible nasal “fingers” conform on nose
- » Ultra-dura® anti-scratch coated polycarbonate lenses absorb 99.99% UV rays
- » Certified to ANSI Z87.1 and meet the requirements of CSA Z94.3 standard



S3760

ITEM #	ORDER #	DESCRIPTION	UOM
S3760	341586001	Clear +1.0 Diopter Lens, Black Frame	EA
S3761	341586011	Clear +1.5 Diopter Lens, Black Frame	EA
S3762	341586021	Clear +2.0 Diopter Lens, Black Frame	EA
S3763	341586031	Clear +2.5 Diopter Lens, Black Frame	EA
S3764	341586041	Clear +3.0 Diopter Lens, Black Frame	EA



Uvex Seismic® Sealed Eyewear with Reading Magnifiers

- » Dual 8-base wrap-around lens provides peripheral vision and protection
- » Replaceable, sealed, flame-resistant, cushion-lined subframe
- » Face cushioning and padded temple tips
- » Soft, flexible nose pads reduce slippage
- » Uvextra™ anti-fog coated polycarbonate lenses absorb 99.99% UV rays
- » Certified to ANSI Z87+ and meet the requirements of CSA Z94.3 standard



S0661X

ITEM #	ORDER #	DESCRIPTION	UOM
S0661X	341588321	Clear +1.5 Diopter Lens, Black Frame	EA
S0662X	341588331	Clear +2.0 Diopter Lens, Black Frame	EA
S0663X	341588341	Clear +2.5 Diopter Lens, Black Frame	EA



Readers



KleenGuard™ 30-06* Readers Safety Glasses

- » Nylon frames with self-adjusting rubber nose pad
- » Meets ANSI Z87.1+ standards
- » Hard coated polycarbonate lenses for scratch resistance
- » Lenses provide 99.9% UVA/ UVB/UVC protection



19876

ITEM #	ORDER #	DESCRIPTION	UOM
19876	C24121701	Clear +1.0 Diopter Lens, Black Frames	EA
19878	C24121711	Clear +1.5 Diopter Lens, Black Frames	EA
19879	C24121721	Clear +2.0 Diopter Lens, Black Frames	EA
19891	C24121731	Clear +2.5 Diopter Lens, Black Frames	EA
19892	C24121741	Clear +3.0 Diopter Lens, Black Frames	EA



KleenGuard™ 30-06* Dual Readers Safety Glasses

- » Integrated diopters (“cheaters”) on the top and bottom of the lenses, for vision assistance when looking up or down
- » 7 base curve lens helps provide for peripheral vision and protection
- » Ergonomic frame with self-adjusting rubber nose pad
- » Meets ANSI Z87.1+ standards, TAA compliant
- » Hard coated polycarbonate lenses for scratch resistance
- » Lenses provide 99.9% UVA/ UVB/UVC protection



20387

ITEM #	ORDER #	DESCRIPTION	UOM
20387	C24122081	Clear +1.5 Diopter Lens, Black Frames	EA
20388	C24122091	Clear +2.0 Diopter Lens, Black Frames	EA
20389	C24122101	Clear +2.5 Diopter Lens, Black Frames	EA



KleenGuard™ Nemesis* Readers Safety Glasses

- » Wraparound frame has a base curve of 8 that extends peripheral protection
- » Patented FLEX-DRY* designed to channel sweat away from the eyes and down the nose
- » Soft touch temples for comfort
- » Furnished neck cord
- » Impact and scratch-resistant polycarbonate lenses absorb 99.99% UV rays
- » Meet the requirements of ANSI / ISEA Z87.1+



28621

ITEM #	ORDER #	DESCRIPTION	UOM
28618	C24120551	Clear +1.0 Diopter Lens, Black Frames	EA
28621	C24120561	Clear +1.5 Diopter Lens, Black Frames	EA
28624	C24120571	Clear +2.0 Diopter Lens, Black Frames	EA
28627	C24120581	Clear +2.5 Diopter Lens, Black Frames	EA
28630	C24120591	Clear +3.0 Diopter Lens, Black Frames	EA
22516	C24124291	Smoke +1.5 Diopter Lens, Black Frames	EA
22518	C24124681	Smoke +2.0 Diopter Lens, Black Frames	EA
22519	C24124621	Smoke +2.5 Diopter Lens, Black Frames	EA



Readers



38503



38505



KleenGuard™ Nemesis* with RX Inserts Safety Glasses

- » Fill your eye prescription on the included RX inserts and insert them into the glasses
- » The corrective lenses are hard coated for scratch resistance and longer life
- » Adjustable ratchet-action temples with five positions for custom fit
- » Furnished neck cord
- » Anti-fog, hard coated polycarbonate lenses absorb 99.99% UV rays
- » Meet the requirements of ANSI Z87.1+

ITEM #	ORDER #	DESCRIPTION	UOM
38503	C24185031	Clear Lens, Black Frame	EA
38504	C24185041	Amber Lens, Black Frame	EA
38505	C24185151	Smoke Lens, Black Frame	EA
38507	C24185071	Indoor/Outdoor Lens, Black Frame	EA



BKH10



BKH20G



BearKat® Magnifier Safety Glasses

- » Single lens design with integral side shields for unobstructed view
- » Non-Slip soft temple material
- » Exclusive Duramass® scratch resistant coating
- » Rugged polycarbonate lens filters 99.9% of harmful U.V. rays
- » ANSI Z87+ and CSA Z94.3

ITEM #	ORDER #	DESCRIPTION	UOM
BKH10	331400031	Clear +1.0 Diopter Lens, Clear Temples	EA
BKH15	331400051	Clear +1.5 Diopter Lens, Clear Temples	EA
BKH20	331400071	Clear +2.0 Diopter Lens, Clear Temples	EA
BKH25	331400091	Clear +2.5 Diopter Lens, Clear Temples	EA
BKH15G	331400061	Gray +1.5 Diopter Lens, Gray Temples	EA
BKH20G	331400081	Gray +2.0 Diopter Lens, Gray Temples	EA
BKH25G	331400201	Gray +2.5 Diopter Lens, Gray Temples	EA



Goggles

3M

3M™ 334 Splash Goggles

- » Indirect-venting system designed to circulate air and help minimize fogging while keeping liquids out
- » Over-the-glass coverage, adjustable elastic strap
- » Polycarbonate lens absorbs 99.9% UV
- » Meets the requirements of ANSI Z87.1-2003

ITEM #	ORDER #	DESCRIPTION	UOM
40660-00000-10	665574851	Clear Lens, Clear Frame	EA
40661-00000-10	665573051	Clear Anti-Fog Lens, Clear Frame	EA



40660-00000-10

3M

3M™ Centurion™ Goggles

- » Wide-angle wraparound lens and frame for good peripheral vision
- » Accommodates prescription eyewear, wide elastic strap
- » Polycarbonate lens absorbs 99.9% UV
- » Meets the requirements of CSA Z94.3-2007 and ANSI Z87.1-2010

ITEM #	ORDER #	DESCRIPTION	UOM
--------	---------	-------------	-----

Direct Venting System

40301-00000-10	665572951	Clear Anti-Fog Lens, Clear Frame	EA
----------------	-----------	----------------------------------	----

Indirect Venting System

40304-00000-10	665572961	Clear Lens, Clear Frame	EA
----------------	-----------	-------------------------	----

40305-00000-10	665572971	Clear Anti-Fog Lens, Clear Frame	EA
----------------	-----------	----------------------------------	----



40301-00000-10

3M

3M™ Fectoggles™

- » Aspheric lens helps provide expansive coverage and an extended viewing range
- » Foam flange seals the perimeter of the lens to help keep out particulates and sweat
- » DX™ anti-scratch and anti-fog polycarbonate coated lens absorbs 99.9% UV
- » Meets the requirements of CSA Z94.3-2007 and ANSI Z87.1-2010

ITEM #	ORDER #	DESCRIPTION	UOM
--------	---------	-------------	-----

With Elastic Strap

16400-00000-10	665572031	Clear Lens, Black Frame, Size Medium	EA
----------------	-----------	--------------------------------------	----

With Adjustable Temples

16420-00000-10	665572591	Clear Lens, Black Frame, Size Large	EA
----------------	-----------	-------------------------------------	----



16400-00000-10

3M

3M™ Lexa™ Splash GoggleGear™

- » Aspheric lens provides expansive coverage and a virtually unobstructed viewing range
- » Fully assembled goggles with soft flange seals and adjustable headband
- » Vented channels to increase airflow, minimize fogging and keep out particulates
- » DX™ anti-scratch and anti-fog polycarbonate coated lens absorbs 99.9% UV
- » Meets the requirements of CSA Z94.3-2007 and ANSI Z87.1-2010

ITEM #	ORDER #	DESCRIPTION	UOM
16644-00000-10	665522731	Clear Lens, Clear Frame, Size Medium	EA
16645-00000-10	665522741	Clear Lens, Clear Frame, Size Large	EA



16644-00000-10



Goggles



3M

40686-00000-10

3M™ Maxim™ 2 x 2 Goggles

- » Lightweight safety goggle protects from sun, wind, dust and flying debris
- » Choice of elastic strap for a secure fit or flexible fit temples
- » Anti-fog polycarbonate coated lens absorbs 99.9% UV
- » Meets the high impact requirements of ANSI Z87.1-2010

ITEM #	ORDER #	DESCRIPTION	UOM
40686-00000-10	665570271	Clear Lens, Black Frame	EA
40687-00000-10	665522401	Gray Lens, Black Frame	EA



21GB78



21GB9F



Swap® Safety Eyewear

- » Temples and head strap included, which can be switched out with the simple push of a button
- » Foam-lined frame helps block dust and debris, with venting channels to minimize fogging
- » Rubberized temple tips for comfort
- » Polycarbonate lens absorbs 99.9% UV
- » Meets the requirements of ANSI Z87.1-2003
- » UL® certified to meet ANSI Z87.1+ and CSA Z94.3 also specification MIL PRF-32432 (GL)

ITEM #	ORDER #	DESCRIPTION	UOM
21GB78	323321781	Gray Anti-Fog Lens, Black Frame	EA
21GB9F	323327201	Blue Mirror Anti-Fog Lens, Black Frame	EA



3M

GG501NSGAF

3M™ GoggleGear™ 500-Series

- » 3M™ Scotchgard™ Anti-Fog Coating, increases eyewear performance in wet and steamy environments
- » The coating withstands disinfection with diluted bleach soaking or alcohol wipes without losing its anti-fog performance
- » Washing with soap and water is considered a best practice and can enhance coating durability
- » Low-profile design with an adjustable neoprene strap and indirect ventilation
- » Polycarbonate coated lens absorbs 99.9% UV
- » Meets the requirements of ANSI Z87.1 and CSA Z94.3

ITEM #	ORDER #	DESCRIPTION	UOM
GG501NSGAF	665542211	Clear Lens, Gray and Red Frame	EA

Accessories

GG500-NeoStrap	665539201	Elastic Neoprene Strap	EA
GG500-ClthStrap	665539211	Elastic Cloth Strap	EA



5104-02



Zion X™ Safety Goggles

- » Anti-fog and scratch resistant coating on lenses
- » High impact polycarbonate lens absorbs 99.9% UV
- » Indirect ventilated rubber seal
- » Adjustable elastic fabric 1" head strap
- » Meets ANSI Z87.1-2015

ITEM #	ORDER #	DESCRIPTION	UOM
5104-01	G73580001	Clear Lens, Black Frame	EA
5104-02	G73580011	Gray Lens, Black Frame	EA
5104-03	G73580021	Yellow Lens, Black Frame	EA
5104-04	G73580031	Mirror Lens, Black Frame	EA

WARNING: Cancer and Reproductive Harm - www.P65Warnings.ca.gov



Goggles



Honeywell
UVEX®

S3400X

Uvex Flex Seal Goggles

- » Lightweight, cured silicone body conforms to assure eye protection
- » Uvextreme® anti-fog coating and indirect venting system minimize fogging
- » Pivoting clips allows the wearer to position on a hard hat or above the ears
- » Fits over most prescription eyewear, neoprene headband
- » Polycarbonate lens provides full field of vision
- » Meets the requirements of ANSI Z87.1+ and CSA Z94.3 standard

ITEM #	ORDER #	DESCRIPTION	UOM
S3400X	341534001	Clear Lens, Navy Frame	EA



Honeywell
UVEX®

S360

Uvex Classic Goggles

- » Uvextreme® anti-fog polycarbonate coated lens
- » Fits over most prescription eyewear, neoprene headband
- » Meets the requirements of ANSI Z87.1+ and CSA Z94.3 standard

ITEM #	ORDER #	DESCRIPTION	UOM
Indirect Vent			
S360	341532901	Clear Lens, Clear Body	EA
Hood Indirect Vent			
S350	341532881	Clear Lens, Clear Body	EA



Honeywell
UVEX®

S345C

Uvex Futura™ Goggles

- » Wrap-around style provides excellent panoramic vision
- » Frosted brow guard reduces glare
- » Indirect venting increases air flow
- » Uvextreme® anti-fog polycarbonate coated lens
- » Fits over most prescription eyewear, neoprene headband
- » Meets the requirements of ANSI Z87.1+ and CSA Z94.3 standard

ITEM #	ORDER #	DESCRIPTION	UOM
S345C	341532851	Clear Lens, Clear Body	EA



Honeywell
UVEX®

S3810

Uvex Strategy Goggles

- » Lightweight, over-the-glass (OTG) goggle, TPE body provides exceptional comfort and a snug fit for maximum protection
- » Direct vent, fabric headband
- » Uvextra® anti-fog coating
- » Fits over most prescription eyewear
- » Meets the requirements of ANSI Z87.1+ and CSA Z94.3 standard

ITEM #	ORDER #	DESCRIPTION	UOM
S3810	341532941	Clear Lens, Gray Body	EA



Goggles



Honeywell
UVEX®

S3960C

Uvex Stealth® Goggles

- » Toric lens provides superior optics and peripheral vision
- » Uvextreme® anti-fog lens coating and indirect ventilation system minimize fogging
- » Flexible soft frame adapts to the face to ensure a perfect fit and seal
- » Quick adjust neoprene headband
- » Easy and economical lens replacement system
- » Meets the requirements of ANSI Z87.1+ and CSA Z94.3 standard

ITEM #	ORDER #	DESCRIPTION	UOM
S3960C	341533001	Clear Lens, Gray Body	EA
S39610C	341533021	Clear Lens, Teal Body	EA



Honeywell
UVEX®

S3970D

Uvex Stealth® OTG Goggles

- » Full view lens that provides superior optics and peripheral vision
- » Dura-streme® hard coat/anti-fog dual coating technology
- » Uvextreme® anti-fog on interior and Ultra-dura® anti-scratch on exterior
- » Flexible soft frame adapts to the face to ensure a perfect fit and seal
- » Pivoting, quick adjust neoprene latex-free headband
- » Easy and economical lens replacement system
- » Meets the requirements of ANSI Z87.1+ and CSA Z94.3 standard

ITEM #	ORDER #	DESCRIPTION	UOM
S3970D	341558741	Clear Lens, Navy Frame	EA



MCR
SAFETY

2230R

Protective Safety Goggles

- » PVC body permits fit over prescription eyewear
- » Exclusive Duramass® scratch resistant coating
- » Polycarbonate lens filters 99.9% of harmful U.V. rays
- » Meets the requirements of ANSI Z87.1+
- » Latex-free strap

ITEM #	ORDER #	DESCRIPTION	UOM
2120	331404551	Clear Lens, Elastic Strap, Size Small	EA
2220R	331479911	Clear Lens, Rubber Strap, Clear Frame	EA

Indirect Vent

2230R	331404681	Clear Lens, Rubber Strap, Clear Frame, Chemical CSA Z94.3 Protection	EA
2235R	331422351	Clear Anti-Fog Lens, Rubber Strap, Clear Frame (Not CSA Tested)	EA

⚠ WARNING: Cancer and Reproductive Harm - www.P65Warnings.ca.gov



MCR
SAFETY

2310AF

Stryker™ Safety Goggles

- » Exclusive Duramass® anti-fog and scratch resistant coating
- » Indirect ventilation
- » Comfortable seal around the face, rubber adjustable strap
- » Polycarbonate lens filters 99.9% of harmful U.V. rays
- » ANSI Z87+ and CSA Z94.3

ITEM #	ORDER #	DESCRIPTION	UOM
2310AF	331404701	Clear Lens, Smoke Frame	EA

⚠ WARNING: Cancer and Reproductive Harm - www.P65Warnings.ca.gov



Goggles



KleenGuard™ V80 Wildcat* Safety Goggles

- » Extreme heat resistance; this eyewear will not melt, drip or ignite at 350°F for five minutes
- » Metal-free design and sliding side vents for optimal airflow; pliable frame is comfortable to wear all day
- » Polycarbonate lenses provide 99.9% UVA/UVB/UVC protection
- » Meets ANSI Z87.1+ standards, D3 rating (droplet and splash protection), D4 rating (for dust protection)



20525

ITEM #	ORDER #	DESCRIPTION	UOM
20525	C24120951	Clear Anti-Fog Lens, Black Frame	EA
20529	C24120991	IRUV Shade 5.0 Anti-Fog Lens, Black Frame	EA



KleenGuard™ Monogoggle* XTR* OTG Safety Goggles

- » Curved lens for enhanced field of vision and flexible frame conforms to the face for comfort and fit
- » ANSI Z87.1+ standard for impact protection, D3 rating for droplet and splash protection
- » Polycarbonate lenses provide 99.9% UVA/UVB/UVC protection
- » Indirect ventilation protects from splashes and provides increased airflow to minimize condensation and fogging
- » Often fits over most prescription eyeglasses



18624

ITEM #	ORDER #	DESCRIPTION	UOM
18624	C24120021	Clear Anti-Fog Lens, Blue Frame	EA



KleenGuard™ Revolution* OTG Safety Goggle

- » Indirect ventilation protects from splashes and provides increased airflow to minimize condensation and fogging
- » The lens is hard coated for scratch protection and longer life
- » Fits over most prescription eyeglasses and features adjustable headband buckles for a snug fit
- » ANSI Z87.1+ standard for impact protection and D3 rating for droplet and splash protection



14399

ITEM #	ORDER #	DESCRIPTION	UOM
14399	C24124011	Clear Anti-Fog Lens, Blue Frame	EA



KleenGuard™ V90 Shield* Goggle Shield*

- » Shield features the Monogoggle* XTR* goggles, no need to wear primary eye protection
- » Face shield mask is curved to conform to the shape of face
- » Meets ANSI Z87.1+ and D3 rating for droplet and splash protection
- » Polycarbonate lenses provide 99.9% UVA/UVB/UVC protection
- » Indirect ventilation protects from splashes and provides increased airflow to minimize condensation and fogging
- » Often fits over most prescription eyeglasses



18629

ITEM #	ORDER #	DESCRIPTION	UOM
18629	C24120111	Clear Anti-Fog Lens, Blue Frame	EA



Accessories



Soft Side Shields

- » Easy-on, easy-off, weaves through the temple
- » Allows temples to fold correctly
- » Blocks 100% of UV rays
- » Molded of soft, bendable vinyl 0.075"
- » Absorbs the energy of impact
- » Conforms to ANSI Z87.1 standards



99705

ITEM #	ORDER #	DESCRIPTION	UOM
99705	325197051	Clear Side Shields	PR



Lens Cleaning Products

- » Lens Cleaning Stations



LCT



LCS1

ITEM #	ORDER #	DESCRIPTION	UOM
LCT	331400105	Individual Wrapped Towelette Packets	100/Bx
LCS1	331402351	8 oz. Cleaning Solution, 2 Bx of 300 Tissues	EA



Uvex Clear® Plus Lens Cleaning Tissues

- » Elegant, non-abrasive, THICKER, soft cloth dry tissue for use with lens cleaning solution products



S474

ITEM #	ORDER #	DESCRIPTION	UOM
S474	341582715	Uvex Clear Plus Cleaning Tissues	500/Pk



Accessories



Uvex Clear® Plus Disposable Lens Cleaning Station

- » Improved formula delivers safe, effective results in an isopropanol- and silicone-free solution that won't damage or delaminate lenses
- » Reduces visible soil to below detectable limits leaving no haze, streaks or residue behind
- » Smells pleasant and is toxic-free
- » 3-5 year shelf life
- » Made in the U.S.A.



S483



S470

ITEM #	ORDER #	DESCRIPTION	UOM
S483	341582761	Uvex Clear Plus Portable, Disposable Lens Cleaning Station - Holds 16 oz. of Uvex Clear Plus cleaning spray and 1,500 tissues	EA
S470	341582735	Uvex Clear Plus Towelettes Pre-moistened, pocket-sized and convenient for use on the go	100/Bx



Uvex Clear® Plus Permanent Lens Cleaning Station

Lens Cleaning Station Includes:

- 16 oz. bottle of Uvex Clear Plus cleaning solution
- 4 boxes of 500 tissues
- 3.5" x 4.5" mirror
- Screw mounts and adhesive foam for quick mounting
- » Cleaning station measures 30"W x 4"L x 14"H



S484



S471



S482

ITEM #	ORDER #	DESCRIPTION	UOM
S484	341582751	Uvex Clear Plus Permanent Lens Cleaning Station	EA
S471	341582721	Uvex Clear Plus Lens Cleaner Solution Refillable 16 oz. spray bottle	EA
S482	341582701	Uvex Clear Plus Lens Cleaner Refill Solution 1-gallon refill bottle	EA



Head & Face Protection



3M

H-701R

3M™ H-700 Series Hard Hat

- » Short-brim design safeguards wearers without weighing them down
- » Blend of protection and wearability
- » 4-point ratchet or pinlock suspension system has brow pad, height adjustment and optional ventilation
- » ANSI/ISEA Z89.1-2014
- » Additional colors and styles available

ITEM #	ORDER #	DESCRIPTION	UOM
H-701R	665527011	White 4-Point Ratchet Suspension, Non-Vented	EA
H-701P	665577821	White 4-Point Pinlock Suspension, Non-Vented	EA
H-701T	665540711	White 4-Point Ratchet, Elevated Temperature Hat, Non-Vented	EA
H-701V	665536041	White 4-Point Ratchet Suspension, Vented	EA



3M

82501-00000

3M™ Ratchet Headgear H8A

- » For use with 3M™ Faceshields (sold separately)
- » High strength thermoplastic crown provides impact resistance
- » Adjustable ratchet suspension with five position crown strap offers a customized fit
- » ANSI Z87.1-2003

ITEM #	ORDER #	DESCRIPTION	UOM
82501-00000	665520871	H8A Ratchet Headgear	EA

WARNING

These eye and face protection products help provide limited eye and face protection. Misuse or failure to follow warnings and instructions may result in serious potential injury, including blindness or death. For proper use, selection, and applications against flying particles, optical radiation and/or splash see supervisor, read User Instructions and warnings on the package or call 3M PSD Technical Service in the USA at 1-800-243-4630. In Canada, call 1-800-267-4414.



3M

H-801R-UV

3M™ H-800 Series Hard Hat

- » Comfortable, tough and lightweight
- » Full-brim hard hats sit lower on the head to reduce pressure and increase security
- » 4-point ratchet suspension system
- » Replaceable brow pad
- » ANSI/ISEA Z89.1-2014
- » Additional colors and styles available

ITEM #	ORDER #	DESCRIPTION	UOM
H-801R	665587211	White 4-Point Ratchet Suspension, Non-Vented	EA
H-801R-UV	665587431	White 4-Point Ratchet Suspension, with Uvicator, Non-Vented	EA



3M

82783-00000

3M™ Ratchet Headgear

82783-00000

- » Safety system comes with headgear and faceshield
- » Molded faceshield provides impact protection
- » Five position crown strap and thirteen position ratchet suspension offer customization to individual wearers
- » ANSI Z87.1-2003

82521-10000

- » Uses WP98 window (82543-0000), sold separately
- » Five position crown strap
- » Requires protective eyewear, sold separately
- » ANSI Z87.1-2003

ITEM #	ORDER #	DESCRIPTION	UOM
82783-00000	665564351	H8A Safety System Comes with Headgear and Faceshield Together, Clear Polycarbonate	EA
82521-10000	665573411	HCP8 Clear Polycarbonate Chin Protector	EA



Head & Face Protection



3M™ Faceshields

- » Mounts quickly to 3M™ headgear systems
- » Mounts inside crown for added splash protection
- » ANSI Z87.1-2003



82702-00000

ITEM #	ORDER #	DESCRIPTION	Size	UOM
82700-00000	665573961	WP96 Clear Propionate	9" x 14.5" x 0.08"	EA
82701-00000	665564341	WP96 Clear Polycarbonate	9" x 14.5" x 0.08"	EA
82702-00000	665573571	WP96C Dark Green Polycarbonate	9" x 14.5" x 0.08"	EA
82543-00000	665573441	WP98 Clear Polycarbonate	7.25" x 14.5" x 0.04"	EA

WARNING

These eye and face protection products help provide limited eye and face protection. Misuse or failure to follow warnings and instructions may result in serious potential injury, including blindness or death. For proper use, selection, and applications against flying particles, optical radiation and/or splash see supervisor, read User Instructions and warnings on the package or call 3M PSD Technical Service in the USA at 1-800-243-4630. In Canada, call 1-800-267-4414.



Classic Series Hard Hats

- » 6-point Flex-Gear® ratchet suspension with large, absorbent cotton brow pad
- » ANSI/ISEA Z89.1-2014, Type I, Class E & G
- » Additional colors available

ITEM #	ORDER #	DESCRIPTION	UOM
Cap Style			
C30FGR	164804841	Forest Green	EA
C30KBR	164804951	Kentucky Blue	EA
C30ORR	164805091	Orange	EA
C30RDR	164805131	Red	EA
C30WHR	164805231	White	EA
C30YLR	164805251	Yellow	EA

Full-Brim

C33KBR	164805971	Kentucky Blue	EA
C33RDR	164806151	Red	EA
C33WHR	164806251	White	EA
C33YLR	164806271	Yellow	EA



C30YLR



C33RDR



Head & Face Protection



Standard Series S51 Hard Hats

- » High-density, polyethylene shell with flat front, low-profile design
- » Accessory slots for attachments
- » Rain trough brim
- » ANSI/ISEA Z89.1-2014
- » Additional colors available



51KBP

ITEM #	ORDER #	DESCRIPTION	UOM
51KBP	164807111	Kentucky Blue, 4-Point Self-Sizing Pinlock Suspension	EA
51WHP	164807661	White, 4-Point Self-Sizing Pinlock Suspension	EA
51YLP	164807701	Yellow, 4-Point Self-Sizing Pinlock Suspension	EA
51KBR	164807131	Kentucky Blue, 4-Point Flex-Gear® Ratchet Suspension	EA
51WHR	164807681	White, 4-Point Flex-Gear® Ratchet Suspension	EA
51YLR	164807721	Yellow, 4-Point Flex-Gear® Ratchet Suspension	EA



Standard Series S61 Hard Hats

- » High-density, polyethylene shell with rounded front, low-profile design
- » 4-point Flex-Gear® ratchet suspension
- » Accessory slots for attachments
- » ANSI/ISEA Z89.1-2014
- » Additional colors available



61HOR

ITEM #	ORDER #	DESCRIPTION	UOM
61HOR	164807971	Orange	EA
61KBR	164808011	Kentucky Blue	EA
61RDR	164808091	Red	EA
61WHR	164808131	White	EA
61YLR	164808151	Yellow	EA



Headpiece Replacement Parts

RBPCOTTON

- » Absorbent cotton replacement brow pad
- » Fits all Bullard® suspensions
- » Easy, Velcro® design

RBPCOOL

- » Polartec replacement brow pad
- » Wicking material moves sweat away from the worker's brow
- » Fits all Bullard® suspensions
- » Easy, Velcro® design



RBPCOTTON

ITEM #	ORDER #	DESCRIPTION	UOM
RBPCOTTON	164802961	Cotton Replacement Brow Pad	EA
RBPCOOL	164810511	Polartec Replacement Brow Pad	EA



Head & Face Protection



Visors

- » For eye and face protection when used in combination with Bullard® headgear or faceshield brackets
- » Available in flat or heat-formed acetate, clear flat or heat-formed polycarbonate, Shade 3 and 5 flat polycarbonate, flat or heat-formed Tritan™, flat polyester and wire mesh screens
- » ANSI/ISEA Z87.1



840P



8S24

ITEM #	ORDER #	DESCRIPTION	Color	Size	UOM
640	164808451	Flat Acetate Visor	Clear	6" x 15" x .040"	EA
640G	164808461	Flat Acetate Visor	Dark Green	6" x 15" x .040"	EA
640PW3	164801331	Polycarbonate Visor	Shade 3	6" x 15" x .040"	EA
640PW5	164801341	Polycarbonate Visor	Shade 5	6" x 15" x .040"	EA
680P	164808471	Polycarbonate Visor, Heat-Formed	Clear	6" x 15" x .080"	EA
840M	164808201	Flat Acetate Visor	Clear	8" x 15" x .040"	EA
840ME	164808801	Flat Polyester Visor	Clear	8" x 15" x .040"	EA
840MG	164808811	Flat Acetate Visor	Dark Green	8" x 15" x .040"	EA
840MH	164808821	Multi-Fit Acetate Visor, Heat-Formed	Clear	8" x 15" x .040"	EA
840MX2	164808831	Flat Acetate Visor for Sentinel 2 Only	Clear	7" x 15" x .040"	EA
840P	164808841	Polycarbonate Visor, Heat-Formed	Clear	8" x 15" x .040"	EA
840PW3	164801361	Flat Multi-Fit Polycarbonate Visor	Shade 3	8" x 15" x .040"	EA
840PW5	164801371	Flat Multi-Fit Polycarbonate Visor	Shade 5	8" x 15" x .040"	EA
840PX2	164808851	Polycarbonate Visor for Sentinel 2 Only, Heat-Formed	Clear	7" x 15" x .040"	EA
840PX2W3	164801381	Polycarbonate Visor for Sentinel 2 Only, Heat-Formed	Shade 3	7" x 15" x .040"	EA
840PX2W5	164801391	Polycarbonate Visor for Sentinel 2 Only, Heat-Formed	Shade 5	7" x 15" x .040"	EA
840T	164814821	Tritan™ Visor, Heat-Formed	Clear	8" x 15" x .040"	EA
840TX2	164801401	Tritan™ Visor for Sentinel 2 Only	Clear	7" x 15" x .040"	EA
860H	164808861	Acetate Visor, Heat-Formed	Clear	8" x 15" x .060"	EA
860P	164808871	Polycarbonate Visor, Heat-Formed	Clear	8" x 15" x .060"	EA
860T	164801481	Tritan™ Visor, Heat-Formed	Clear	8" x 15" x .060"	EA
880P	164809091	Polycarbonate Visor, Heat-Formed	Clear	8" x 15" x .080"	EA
880T	164801431	Tritan™ Visor, Heat-Formed	Clear	8" x 15" x .080"	EA
6S24	164801321	Mesh Screen Visor, Plastic Frames	Black	6" x 15" x 24"	EA
8S24	164808791	Mesh Screen Visor, Metal Frames	Black	8" x 15" x 24"	EA
CS40	164801061	Flat Multi-Fit Acetate Visor	Clear	9" x 19.75" x .040"	EA
E840ME	164801451	Economy Flat Multi-Fit Polyester Visor	Clear	8" x 15" x .040"	EA
WS60PM	164804211	Flat Multi-Fit Polycarbonate Visor	Clear	9" x 19.75" x .060"	EA
WS60TM	164801351	Flat Multi-Fit Tritan™ Visor	Clear	9" x 19.75" x .060"	EA



Gold Line Faceshield Brackets

- » Aluminized
- » Chemical resistance and high-heat
- » ANSI/ISEA Z87.1



100G

ITEM #	ORDER #	DESCRIPTION	UOM
100G	164804331	For Cap Style	EA
112G	164804361	For Full Brim Style	EA



Dielectric Faceshield Brackets

- » Nylon
- » Lightweight
- » ANSI/ISEA Z87.1



300B

ITEM #	ORDER #	DESCRIPTION	UOM
300B	164805261	Band Mounting	EA
300BW	164805271	Band Mounting with Neoprene Gasket	EA



Head & Face Protection

Honeywell

FIBRE-METAL



E2RW71A000



E1RW71A000

SuperEight® Caps and Hats

- » High-quality thermoplastic hats and caps
- » Unique, smooth crown that eliminates the danger of falling objects being trapped by ribs, ridges or slots
- » Wearer can adjust head size by using rear-located ratchet mechanism and tilting the headband
- » All hats and caps include 8-point suspension and available with Fibre-Metal non-slip/non-strip ratchet, SwingStrap™ or TabLok™ headgear
- » All styles are SEI certified to meet ANSI Z89.1-2009, Type 1, Class E
- » Additional colors available

ITEM #	ORDER #	DESCRIPTION	UOM
Hard Cap			
E2RW01A000	614609301	White	EA
E2RW02A000	614609321	Yellow	EA
E2RW15A000	614609311	Red	EA
E2RW71A000	347686911	Blue	EA
E2RW74A000	347686821	Green	EA

ITEM #	ORDER #	DESCRIPTION	UOM
Full Brim Hard Hat			
E1RW01A000	614609151	White	EA
E1RW09A000	614600161	Gray	EA
E1RW11A000	347684541	Black	EA
E1RW71A000	614609271	Blue	EA
E1RW46A289	341573091	Hi-Viz Strong Orange	EA

Honeywell

NORTH

North Zone Hard Hat

- » Slots for cap-mounted earmuffs, face shields and other PPE accessories
- » 3-level height adjustment (Low, Medium, High) for greater stability, balance and retention
- » Removable, replaceable rear comfort cradle for improved fit and comfort
- » Easy-grip ratchet for smooth and precise headband adjustment, even when wearing gloves
- » Ergonomic headband for easy adjustment to 3 different sizes (S, M/L and XL)
- » Approved to be worn in the reverse position
- » Moisture-wicking, breathable sweatband; easily removable, washable and replaceable
- » Short brim and low-profile design for increased field of vision and user mobility
- » ANSI/ISEA Z89.1 2014 Type I, Class C, G and E
- » Additional colors available



N10050000

ITEM #	ORDER #	DESCRIPTION	UOM
Quick-Fit Suspension			
N10010000	341574151	White	EA
N10020000	341574161	Yellow	EA
N10030000	341574171	Orange	EA
N10150000	347600371	Red	EA
N10440000	341574301	Hi-Viz Strong Yellow	EA
N10460000	341574311	Hi-Viz Strong Orange	EA

ITEM #	ORDER #	DESCRIPTION	UOM
Ratchet Suspension			
N10R010000	341574321	White	EA
N10R020000	341574331	Yellow	EA
N10R030000	341574341	Orange	EA
N10R130000	341574431	Gold	EA
N10R150000	341574441	Red	EA
N10R440000	341574471	Hi-Viz Strong Yellow	EA
N10R460000	341574481	Hi-Viz Strong Orange	EA



Head & Face Protection



Turboshield™ Faceshield and Replacement Visors

- » Flexible head-cushioning suspension cradle provides for all-day wear
- » Simple push-button release system allows for easy visor exchange in seconds
- » Control knobs are large and ergonomically designed for easy adjustment — even while wearing gloves
- » More chin coverage compared to traditional visors, without the need for bulky accessories
- » Visor slides back seven inches, improving balance and weight distribution. Enhanced clearance. Dual-hinge design increases clearance by as much as four inches and keeps accessory slots open for compatibility with other PPE
- » ANSI Z87.1-2010 and CSA Z94.3



S9500

ITEM #	ORDER #	DESCRIPTION	UOM
S9500	341595011	Turboshield Ratchet Headgear, Black	EA
S9510	341595101	Turboshield Hard Hat Adapter, Black	EA

Replacement Visors

S9550	341595501	Clear, Uncoated	EA
S9555	341595551	Clear, Hardcoat/Anti-Fog	EA
S9560	341595601	UV/IR Shade 3.0, Uncoated	EA
S9565	341595651	UV/IR Shade 5.0, Uncoated	EA
S9575	341595751	Gray, Hardcoat/Anti-Fog	EA



11380048

Protecto-Shield® Replacement Visors

- » Easy attachment without snaps, posts or levers
- » Reinforced edge to resist cracking
- » Universal hole pattern allows the use of visors with other popular manufacturers' headgear
- » Aluminum bound acetate replacement visors form easily for a contoured, customized fit
- » ANSI Z87+ (High Impact) and CSA Z94.3 safety standards

ITEM #	ORDER #	DESCRIPTION	UOM
11380048	341500481	Polycarbonate, Medium Green	EA
11390064	341500441	Propionate, Clear	EA
11390065	341500471	Polycarbonate, Clear	EA
11390069	341537891	Propionate, Shade 6.0	EA



S8500

Bionic® Faceshield and Replacement Visors

- » Easily replaceable visor with dual position choices
- » Comfortable cell foam on back of headgear
- » Breathable, removable, washable headband
- » Black matte finish
- » Comfortably worn with most goggles and respirators
- » Hard hat accessory is compatible with multiple hard hats
- » Meets ANSI Z87+ (High Impact) and CSA Z94.3 standard

ITEM #	ORDER #	DESCRIPTION	UOM
S8500	341535081	Face Shield with Uncoated Visor	EA
S8510	341535101	Face Shield with Clear Anti-Fog/Hardcoat Visor	EA

Replacement Visors

S8550	341535121	Clear, Uncoated	EA
S8555	341535131	Clear, Anti-Fog/Hardcoat	EA
S8560	341535141	Shade 3.0, Uncoated	EA
S8565	341535151	Shade 5.0, Uncoated	EA

WARNING: Cancer and Reproductive Harm - www.P65Warnings.ca.gov



Head & Face Protection

Honeywell



F300, F400 and F500 Series Faceshield Headgear

- » All models feature lightweight and heat-resistant Noryl® (the same material used in welding helmets) crown protectors and ratchet headbands (windows sold separately)
- » Meets ANSI Z87.1+ High Impact standard and certified to the requirements of the CSA Z94.3 standard

F300

- » Lightweight faceshield headgear provides general face protection
- » Easily fits over spectacles, leaving room for air circulation to prevent fogging
- » Accommodates standard size (8" x 11 1/2") windows

F400

- » Features a deeper 4" crown protector to extend protection without increasing weight
- » Incorporates wide-vision (8" x 17") wraparound windows and screens which provide 40% more protective area than standard size faceshields
- » Fits easily over required spectacles or respirators

F500

- » Includes a broader, deeper 7" crown protector to provide an extra margin of protection
- » Features the exclusive Channel Grip System that mounts wide, wraparound windows and locks them into place to form a perfect seal from dust, dirt and debris
- » Includes Fibre-Metal classic 3-C, free-floating headgear



F500

ITEM #	ORDER #	DESCRIPTION	UOM
F300	347686341	Light-duty faceshield headgear w/ 3" crown protector	EA
F400	614601731	Medium-duty faceshield headgear w/ 4" crown protector	EA
F500	614601761	Heavy-duty faceshield headgear w/ 7" crown protector	EA

Honeywell



Faceshield Headgear Combinations

- » Protective cap-mounting mechanisms easily and safely secure Fibre-Metal® faceshields to hard hats
- » Constructed from Noryl®, these faceshield brackets offer durable protection
- » Model 5000 with Speedy® Loop mounting loops is adjustable and provides easy on and off mounting on protective caps



F5400

ITEM #	ORDER #	DESCRIPTION	UOM
F5400	614601771	F500 faceshield bracket w/ Speedy Loop mounts, 4" crown	EA
F5500	614601781	F500 faceshield bracket w/ Speedy Loop mounts, 7" crown	EA
5000	614606911	5000 Speedy Loop attachment & adapter headband kit	EA



Head & Face Protection

Honeywell



Faceshield Hard Hat Brackets

- » Provides positive seal to keep debris from filtering between cap and shield
- » May be pivoted above cap between uses without removing the cap
- » Hard hat and faceshield not included

ITEM #	ORDER #	DESCRIPTION	UOM
FM70	614602441	Fully dielectric mounting bracket for Fibre-Metal P2, E2 hard hats	EA
FH66	614601811	Aluminum mounting bracket for Fibre-Metal P2, E2 hard hats	EA



FH66

Honeywell



High-Performance® Faceshield Windows

- » Windows are preformed to the exact curve of crown protectors for easy installation, exact fit and perfect seal against dust, dirt and debris
- » .060" thick
- » Easily fit over required protective spectacles or respirators
- » Hard hat and frame not included.



4178CL

ITEM #	ORDER #	DESCRIPTION	COLOR	SIZE	UOM
4118CL	614606221	Standard window, fits F300 Series	Clear	8" x 11 1/4"	EA
4178CL	614606241	Wide window, fits F400, F500 Series & FH66, FM70, FM71	Clear	8" x 16 1/2"	EA
4178DGN	614606251	Wide window, fits F400, F500 Series & FH66, FM70, FM71	Dark Green	8" x 16 1/2"	EA
4178IRUV5	614606271	Wide window, fits F400, F500 Series & FH66, FM70, FM71	Shade 5.0	8" x 16 1/2"	EA
4199CL	614606291	Extended view window, fits F400, F500 Series & FH66	Clear	9 3/4" x 19"	EA
4199DGN	614606301	Extended view window, fits F400, F500 Series & FH66	Dark Green	9 3/4" x 19"	EA
4199IRUV5	614606321	Extended view window, fits F400, F500 Series & FH66	Shade 5.0	9 3/4" x 19"	EA

JACKSON

Jackson Safety® SC-6 Hard Hats

- » Molded from dielectric HDPE (High Density Polyethylene)
- » 4-Point Ratchet from head sizes: 6-1/2 to 8
- » Slots for attaching additional PPE
- » ANSI Z89.1 - 2009, Class C, G & E



14839

ITEM #	ORDER #	DESCRIPTION	UOM
14833	C24115871	Yellow	EA
14834	C24115881	White	EA
14837	C24115901	Green	EA
14838	C24115911	Blue	EA
14839	C24115921	Orange	EA
14841	C24115931	Red	EA



Head & Face Protection



14381



Jackson Safety* Headgear HDG10

- » Secures 12" or 15.5" face shields
- » Soft, absorbent wrap-around foam cushioned sweatband

ITEM #	ORDER #	DESCRIPTION	UOM
14381	C24112961	K-Facesaver	EA



14940



Jackson Safety* Headgear HDG30, 170-SB

- » Compatible with all Jackson Safety Face Shields, sold separately
- » Easily attaches the face shield to the hard hat, sold separately
- » Includes a built-in sweatband
- » Ratchet suspension adjust to fit

ITEM #	ORDER #	DESCRIPTION	UOM
14940	C24116141	Head Gear for Hard Hat	EA



14944



Jackson Safety* 382 B Cap Adapter

- » Dielectric for use with slotted caps
- » Polyethylene spark deflector with pivoting blades
- » Face shields (sold separately) are secured with internal plastic lugs
- » Attaches to Jackson Safety Sentry III, Charger and SC-6 Hard Hats (sold separately)

ITEM #	ORDER #	DESCRIPTION	UOM
14944	C24116191	Capmount Adapter	EA



14946



14947



14948



Jackson Safety* Cap Shields

337

- » Totally dielectric for non-slotted caps
- » Curved plastic channel fits over the bill, secures with adjustable rubber headband
- » Face shields are sold separately
- » Attaches to SC-6, Sentry III and Charger Hard Hats (sold separately)

437

- » Totally dielectric for slotted caps; Face shields are secured with integral plastic lugs
- » Curved plastic channel fits over the bill, includes pivoting blades that snap into cap slots
- » Face shields are sold separately
- » Attaches to SC-6, Sentry III and Charger Hard Hats (sold separately)

137

- » Metal device for non-slotted caps
- » Curved aluminum channel and coil spring attachment
- » Face shields are sold separately
- » Attaches to SC-6, Sentry III and Charger Hard Hats (sold separately)

ITEM #	ORDER #	DESCRIPTION	UOM
14946	C24116211	337 Capshield	EA
14947	C24116221	437 Capshield	EA
14948	C24116231	137 Capshield	EA



Jackson Safety* Hatshield Attachment

- » Easily attaches faceshields
- » Aluminum channel and coil spring attachment
- » Face shields are sold separately
- » Attaches only to full-brim hard hats

ITEM #	ORDER #	DESCRIPTION	UOM
14393	C24112701	Model H Bracket Hat Adapter	EA
14945	C24116201	37 Spring Mounted Hat Adapter	EA

Head & Face Protection



14393



14945



Jackson Safety* Faceshields

- » Various materials available for different uses
- » Designed for use with Jackson Safety headgear
- » ANSI Z87.1



29090



29055

ITEM #	ORDER #	DESCRIPTION	Size	UOM
F20 Polycarbonate				
29087	C24118581	Polycarbonate, Clear, Unbound	8" x 15.5" x .060"	EA
F30 Acetate				
29052	C24114231	Acetate, Clear Bound	8" x 15.5" x .040"	EA
29053	C24114301	Acetate, Medium Green, Bound	8" x 15.5" x .040"	EA
29079	C24118381	Acetate, Clear, Bound	9" x 15.5" x .040"	EA
29082	C24118471	Acetate, Light Green, Bound	9" x 15.5" x .040"	EA
29090	C24118641	Acetate, Dark Green, Bound	9" x 15.5" x .040"	EA
29091	C24118671	Acetate, Clear, Bound	9" x 15.5" x .040"	EA
F40 Polycarbonate				
29080	C24118401	Polycarbonate, IRUV 5.0, Unbound	8" x 15.5" x .060"	EA
F60 Wire Mesh				
29055	C24114221	Wire Face Shield - Mesh, Bound	8" x 15.5" x .020"	EA
29102	C24126011	F60 Wire Face Shield - Mesh, Bound	6" x 15" x .0"0"9	EA

⚠ WARNING: Cancer and Reproductive Harm - www.P65Warnings.ca.gov



Headgear and Faceshields

- » Headgear and faceshields offer superior protection from liquid splashes and flying debris
- » Assortment of brackets, faceshield sizes and materials



103



101640

ITEM #	ORDER #	DESCRIPTION	Size	UOM
102	331404401	Aluminum Face Shield Bracket for Hardhat		EA
103	331401031	Ratchet Take Up Headgear		EA
101640	331404391	Clear PETG Faceshield	10" x 15.5" x .040"	EA
102040	331404411	Visor, Clear PETG Faceshield	10" x 20" x .040"	EA
181540	331404461	Visor, Clear Polycarbonate Faceshield	8" x 15.5" x .040"	EA
181560	331404471	Clear Polycarbonate Faceshield	8" x 15.5" x .060"	EA
181640	331410721	Clear PETG Faceshield	8" x 16" x .040"	EA
181640A	331404481	Clear PETG Faceshield Aluminum Bound	8" x 16" x .040"	EA



Head & Face Protection



V-Gard® Frames

- » Unique 3-point visor loading to fit and remove visors quickly
- » Sloped design allows material to easily slide off the frame
- » Perfect Compatibility with many half-mask respirators and more
- » Non-metal construction for use in electrical applications
- » Replaceable, optional debris control creates tight seal between frame and helmet
- » Universal= Heavy-duty, flat, rubber strap for easy and secure placement on MSA slotted and non-slotted helmets
- » ET frames are tested to temperatures of 350°F (176.7°C), reducing warping, cracking or crazing
- » ANSI/ISEA Z87.1-2010 and CSA Z94



10154622

ITEM #	ORDER #	DESCRIPTION	UOM
10115730	3085850D1	HDPE Frame for MSA Slotted Caps	EA
10121266	3085851D1	HDPE Frame for MSA Slotted Caps, w/o Debris Control	EA
10115822	3085852D1	HDPE Frame for Universal MSA Caps, w/o Debris Control	EA
10121268	3085853D1	HDPE Frame for Universal MSA Caps, w/o Debris Control	EA
10115821	308558281	Polycarbonate Frame for Slotted MSA Caps, Elevated Temp	EA
10154622	308546221	PBT Frame for Slotted Full-Brim MSA Caps	EA



V-Gard® Visors

- » Designed for use with V-Gard® Frames and V-Gard® Headgear
- » ANSI/ISEA Z87.1-2010



10115855

ITEM #	ORDER #	DESCRIPTION	Size	UOM
10115836	3085355E1	Polycarbonate, Contoured, Clear PC	8" x 17" x 0.04"	EA
10115840	308507381	Polycarbonate, Contoured, Clear PC	8" x 17" x 0.06"	EA
10115855	3085340E1	Propionate, Clear, Molded	8" x 17" x 0.098"	EA
10116557	3085854D1	Plastic Edged Wire Mesh	8" x 17"	EA



10148708

Replacement Suspensions for V-Gard® Caps and Hats

- » For Staz-on® and Fas-Trac® III suspensions

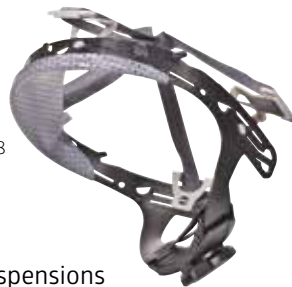

ITEM #	ORDER #	DESCRIPTION	UOM
10087218	3085196C1	Staz-On® Suspension for, V-Gard® Cap or Hat	EA
10153385	308501811	Fas-Trac® III Replacement Suspension, for Skullgard® and Comfo-Cap® Helmets	EA
10148708	308587081	Fas-Trac® III Replacement Suspension for V-Gard®, V-Gard® 500, V-Gard® GREEN and SmoothDome® Helmets	EA



696688



Terri-Band Sweatbands

- » Snap-in sweatbands fit all MSA helmets
- » Absorbent and comfortable
- » Machine washable

ITEM #	ORDER #	DESCRIPTION	UOM
696688	308566885	Sweatbands	10/Pk



Head & Face Protection



V-Gard® Protective Cap

- » Polyethylene shell provides superior impact protection
- » Self-adjusting crown straps ensure a comfortable fit
- » Slots designed to work with MSA accessories to help ensure compliance with both the helmet and the accessory
- » ANSI/ISEA Z87.1-2009, Type 1, Class E



475359



463947

ITEM #	ORDER #	DESCRIPTION	UOM
Slotted Cap with Staz-On® Suspension			
463942	308571271	White	EA
463943	308571281	Blue	EA
463944	308571301	Yellow	EA
463945	308571321	Orange	EA
463947	308571311	Red	EA
815558	308505581	Bright Lime Green	EA

ITEM #	ORDER #	DESCRIPTION	UOM
Slotted Cap with Fas-Trac® III Suspension			
475358	308503581	White	EA
475359	308506451	Blue	EA
475360	308506441	Yellow	EA
475361	308553611	Orange	EA
475363	308508811	Red	EA
815565	3085226B1	Bright Lime Green	EA
10061512	308536791	Hi-Viz Yellow	EA



475368

V-Gard® Full Brim Protective Hat

- » Polyethylene shell provides superior impact protection
- » Self-adjusting crown straps ensure a comfortable fit
- » Additional colors available
- » Meets ANSI Z89.1-2014, Type 1, Class E, CSA Z94.1-2015 (Class E) and voluntary standard for low temperature [LT] and reverse donning

ITEM #	ORDER #	DESCRIPTION	UOM
Slotted with Staz-On Suspension			
454732	308547541	Blue	EA
454733	308547331	White	EA
454734	308547551	Orange	EA
454735	308547561	Green	EA
454736	308547361	Red	EA

ITEM #	ORDER #	DESCRIPTION	UOM
Slotted with Fas-Trac® III Suspension			
475366	308555661	Yellow	EA
475367	308555671	Gray	EA
475368	308553681	Blue	EA
475369	308553701	White	EA
475370	308555681	Green	EA
475371	308553711	Red	EA
815570	308599251	Bright Lime-Green	EA
10021292	308520351	Hi-Viz Orange	EA



10034020

V-Gard® 500 Vented Protective Hat

- » Robust design, durable shell construction
- » Cooling vents for improved air circulation and comfort
- » Glaregard® Surface underbrim to reduce reflective glare
- » Lateral contours for easy integration of hearing protection
- » Extended rain trough for around-the-brim protection in hot and/or wet environments
- » Meets all applicable requirements for a Type I (top impact) helmet as outlined in ANSI/ISEA Z89.1-2014: Vented (Class C). Also meets the ANSI/ISEA Z89.1-2014 voluntary standard for low temperature [LT] and reverse donning.

ITEM #	ORDER #	DESCRIPTION	UOM
Caps with Fas-Trac® III Suspension			
10034018	308528161	White 4-Point Fas-Trac® III	EA
10034019	308528171	Blue 4-Point Fas-Trac® III	EA
10034020	308528181	Yellow 4-Point Fas-Trac® III	EA
10034027	308540271	White 6-Point Fas-Trac® III	EA
10034029	308528231	Yellow 6-Point Fas-Trac® III	EA



Head & Face Protection



Specialty V-Gard® Protective Caps

- » Industrial-strength head protection that's lightweight yet durable
- » Featuring Fas-Trac® III Suspension and slots for better impact resistance and personal comfort
- » Meet all applicable requirements for a Type I (top impact) helmet as outlined in ANSI/ISEA Z89.1-2014 (Class E) and CSA Z94.1-2015 (Class E).
- » Meet the ANSI/ISEA Z89.1-2014 and CSA Z94.1-2015 voluntary standard for reverse donning



10052945

ITEM #	ORDER #	DESCRIPTION	UOM
10052945	308536521	American Stars & Stripes	EA



Skullgard® Protective Caps and Hats

- » Skullgards have been tested to radiant heat loads producing temperatures up to, but not exceeding 350°F
- » Smooth crown for easy use of MSA welding equipment
- » Meets all applicable requirements for a Type I (top impact) helmet as outlined in ANSI/ISEA Z89.1-2014 (Class G).
- » Meets the ANSI/ISEA Z89.1-2014 voluntary standard for low temperature [LT].



475395



475407

ITEM #	ORDER #	DESCRIPTION	UOM
--------	---------	-------------	-----

Caps

454617	308547221	Natural Tan - with Staz-On® Suspension	EA
475395	308555791	Natural Tan - with Fas-Trac® III Suspension	EA

Hats

454664	308547301	Natural Tan - with Staz-On® Suspension	EA
475407	308555861	Natural Tan - with Fas-Trac® III Suspension	EA



Cowboy Style Hard Hat

- » 6-point deluxe nylon squeeze-lock suspension
- » Front cotton terry sweatband
- » Extra wide brim provides more UV protection
- » ANSI Z89.1 Type 1, class E & G



VCB200-B

ITEM #	ORDER #	DESCRIPTION	UOM
VCB200-B	325302741	Black	EA
VCB200-G	325302751	Gray	EA
VCB200-T	325302761	Tan	EA
VCB200-W	325302771	White	EA



Head & Face Protection



Tuff Nougies Doo Rags

- » 100% Cotton
- » Double cotton layer around forehead for added comfort
- » Rear tie for secure fit

Flame Resistant

- 6 oz. flame resistant treated cotton soft to the touch
- Nomex® thread
- Meets ASTM F1506
- Arc Rating: ATPV = 7.2 cal/cm²
- NFPA 70E/HRC = 1
- Flame resistant through 50 home washes



TN5-WAV

ITEM #	ORDER #	DESCRIPTION	UOM
TN5-BLACK	325302341	Black	EA
TN5-INFR-04	325316191	Flame Resistant Green	EA
TN5-NAV	325302411	Navy	EA
TN5-WAV	325302441	Wavy Flag	EA
TN5-INFR-018	325316181	Flame Resistant Navy	EA
TN5-INFR-FR11	325316111	Flame Resistant Gray	EA
TN5-INFR-HVY	325316131	Flame Resistant HIGHVIZ Yellow	EA
TN5-INFR-KHK	325316211	Flame Resistant - Khaki	EA



Baseball Cap Bump Cap

- » Polyethylene inside 100% polyester twill ball cap protects against bumps and scrapes
- » Polyurethane bump cap insert included (V400)
- » Insert fits most "high profile" or "pro style" ball caps



V410

ITEM #	ORDER #	DESCRIPTION	UOM
V400	325302171	Insert For Baseball Style Bump Cap	EA
V410	325302161	Baseball Cap with Insert	EA



870B20-01



Snap-On Hard Hat Sweatband

- » #1 selling terry sweatband
- » Easily attaches to hard hat suspension with snaps

ITEM #	ORDER #	DESCRIPTION	UOM
870B20-01	325302671	Navy	EA
870B20-15	325302651	Beige	EA



SWEATSOpad® Sweatbands



20-3100V

- » One size fits all, hook and loop closure
- » Orange
- » Flame retardant fleecy cotton outer layer
- » Air-cushioned foam inner layer

ITEM #	ORDER #	DESCRIPTION	UOM
20-3100V	C25400605	Welding Helmet Sweatband	2/Pk
20-3200V	C25400615	Hard Hat Sweatband	2/Pk



Earplugs

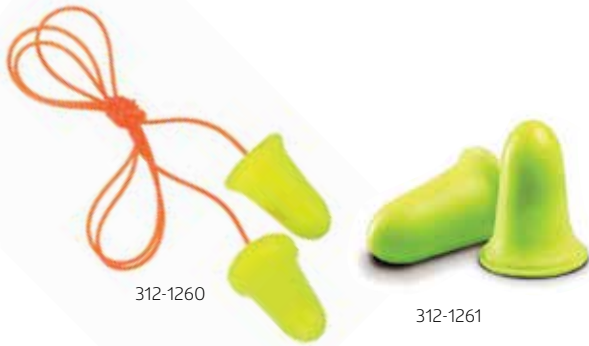

3M

3M™ E-A-Rsoft™ FX™ Earplugs

- » Poly bag keeps each pair of earplugs clean before use
- » Bell shape allows easy fitting and removal
- » Noise Reduction Rating (NRR)* 33 dB. CSA Class AL

ITEM #	ORDER #	DESCRIPTION	UOM
312-1260	665572795	Corded	200 Pr/Bx
312-1261	665572805	Uncorded	200 Pr/Bx

3M

3M™ E-A-Rsoft™ Yellow Neons™ and Yellow Neon Blasts™ Disposable Foam Earplugs

- » Soft, pliable foam offers comfort for wearing over an extended time
- » Low-pressure foam makes plugs less noticeable
- » Earplugs are easy to roll down for quick and easy insertions
- » Noise reduction rating (NRR)* 33 dB CSA Class AL
- » Poly bag keeps each pair of earplugs clean before use

ITEM #	ORDER #	DESCRIPTION	UOM
311-1250	665572075	Yellow Neon, Corded	200 Pr/Bx
312-1250	665522765	Yellow Neon, Uncorded	200 Pr/Bx
311-1252	665563975	Yellow Neon Blasts, Corded	200 Pr/Bx
312-1252	665572295	Yellow Neon Blasts, Uncorded	200 Pr/Bx

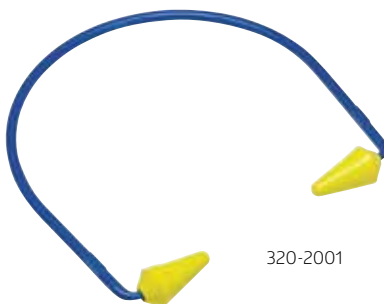
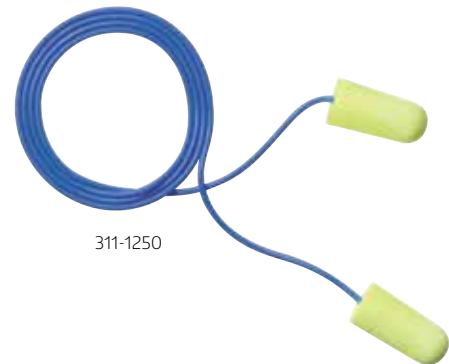

3M

3M™ E-A-R™ Caboflex™ Model 600 Hearing Protector

- » Silicone tips contain a foam core for an effective seal and good noise reduction
- » Flexible band can be worn under the chin for use with hard hats
- » Ideal for intermittent hearing protection needs
- » Replacement pods also available
- » Noise Reduction Rating (NRR)* 20 dB when the band is worn under-the-chin; 17 dB when the band is worn behind-the-head. CSA Class BL

ITEM #	ORDER #	DESCRIPTION	UOM
320-2001	665564265	Yellow Neon, Banded	10/Bx

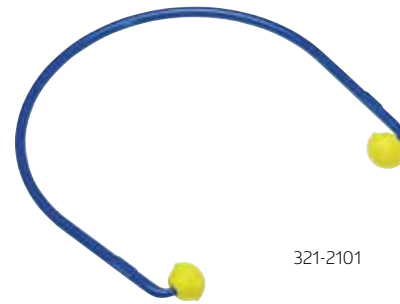

3M

3M™ E-A-R™ Caps™ Model 200 Hearing Protector

- » Soft foam caps block the entrance to the ear canal. Band is worn under the chin
- » Ideal for intermittent protection needs.
- » Noise Reduction Rating (NRR)* 17 dB. CSA Class BL
- » Test compatible with 3M™ E-A-Rfit™ Validation System

ITEM #	ORDER #	DESCRIPTION	UOM
321-2101	665574965	Yellow Neon Caps, Banded	10/Bx

*The NRR may overestimate the hearing protection provided during typical use. 3M recommends reducing the NRR by 50% for estimating the amount of noise reduction provided. Noise Reduction Rating (NRR): dB CSA Class AL. Test compatible with 3M™ E-A-Rfit™ Validation System. 3M™ is Leading the Advancement of Hearing Conservation™.



Earplugs



3M™ E-A-R™ Classic™ Earplugs

- » 3M™ E-A-R™ Classic™ Earplugs set the standard in hearing protection as the world's first foam earplugs
- » One size comfortably fits most ear canals
- » Bright yellow allows quick hearing protection compliance checks



310-1101



311-1101

ITEM #	ORDER #	DESCRIPTION	UOM
311-1081	665522485	(NRR)* 29 dB, Classic Corded, Econopack	500 Pr/Bx
312-1082	665572785	(NRR)* 29 dB, Classic Uncorded, Econopack	1,000 Pr/Bx
310-1001	665564465	(NRR)* 29 dB, Classic Uncorded, Pillow Pack	200 Pr/Bx
311-1101	665522755	(NRR)* 29 dB, Classic Corded, Poly Bag	200 Pr/Bx
312-1201	665521395	(NRR)* 29 dB, Classic Uncorded, Poly Bag	200 Pr/Bx
310-1101	665572675	(NRR)* 33 dB, Classic Plus, Uncorded, Pillow Pack	200 Pr/Bx
311-1105	665573745	(NRR)* 33 dB, Classic Plus, Corded, Poly Bag	200 Pr/Bx
390-1000	665564475	(NRR)* 29 dB, Classic Uncorded, Value Pack Dispenser	200 Pr/Bx
391-1001	665521305	(NRR)* 29 dB, Classic Uncorded Refill Bottles for One Touch Dispenser	500 Pr/Btl



3M™ E-A-R™ Classic SuperFit™ 30 and 33 Earplugs

- » Orange "fitting ring" provides a guideline for proper insertion and quick visual compliance check
- » Slow recovery, low pressure foam yet stiff enough to make fitting easy
- » Standard size earplug fits most people comfortably
- » Dermatologically safe foam is non-irritating
- » Moisture and flame resistant

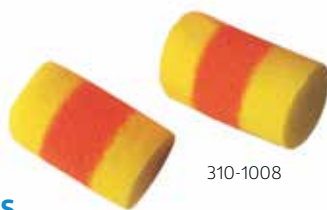

310-1008



312-1208



312-1222



3M™ E-A-R™ E-Z Fit™ Earplugs

- » Bell-shaped earplugs roll down easily and then expands to block noise
- » Poly bag keeps each pair of earplugs clean before use
- » Ideal for smaller ear canals

ITEM #	ORDER #	DESCRIPTION	UOM
Pillow Pack			
310-1008	665572635	(NRR)* 33 dB, Uncorded	200 Pr/Bx
310-1009	665572645	(NRR)* 30 dB, Uncorded	200 Pr/Bx
Poly Bag			
311-1125	665573785	(NRR)* 33 dB, Corded	200 Pr/Bx

ITEM #	ORDER #	DESCRIPTION	UOM
312-1208	665520855	(NRR)* 28 dB, Uncorded	200 Pr/Bx
312-1222	665564205	(NRR)* 28 dB, Corded	200 Pr/Bx

*The NRR may overestimate the hearing protection provided during typical use. 3M recommends reducing the NRR by 50% for estimating the amount of noise reduction provided. Noise Reduction Rating (NRR): dB CSA Class AL. Test compatible with 3M™ E-A-Rfit™ Validation System. 3M™ is Leading the Advancement of Hearing Conservation™.



Earplugs



3M™ E-A-R™ UltraFit™ Metal Detectable Earplugs

- » Metal-detectable ball bearing for high detectability
- » Premolded, triple flange earplugs fit comfortably in a wide range of ear sizes
- » Soft polymer is washable and reusable



340-4007

ITEM #	ORDER #	DESCRIPTION	UOM
340-4007	665574985	(NRR)* 21 dB, Corded, Poly Bag	100 Pr/Bx
340-4017	665522155	(NRR)* 21 dB, Corded, Econopack	200 Pr/Bx



3M™ E-A-R™ Express™ Metal Detectable Pod Plugs™

- » Implanted stainless steel ball bearings aid in locating lost earplugs
- » Designed for food processing and other industries where it is critical to keep earplugs from contaminating products and processes
- » Paddle-style grips provide quick, clean and consistent placement of earplugs
- » No-roll design keeps fingers, earplugs and ears clean



311-1127

ITEM #	ORDER #	DESCRIPTION	UOM
311-1127	665573795	(NRR)* 26 dB, Corded	100 Pr/Bx



3M™ E-A-Rsoft™ Metal Detectable Earplugs

- » Soft, pliable foam offers comfort for wearing over an extended time
- » Implanted stainless steel ball bearing and metal particles aid in locating lost earplugs
- » Regular size fits most ear canals



311-4106

ITEM #	ORDER #	DESCRIPTION	UOM
311-4106	665574835	(NRR)* 32 dB, Corded	200 Pr/Bx



311-1114

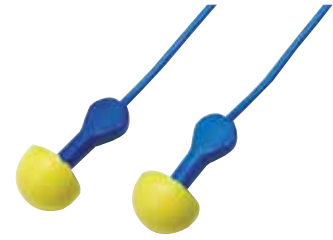

3M™ E-A-R™ Express™ Pod Plugs™

- » Paddle-style grips provide quick, clean, and consistent placement of earplugs
- » No-roll design keeps earplugs, and ears clean, even when fingers or gloves are dirty
- » Reusable pillow pack helps keep earplugs clean when they are not being worn

ITEM #	ORDER #	DESCRIPTION	UOM
311-1114	665572275	(NRR)* 25 dB, Blue Grips, Corded	100 Pr/Bx
311-1115	665574975	(NRR)* 25 dB, Assorted Color Grips, Corded,	100 Pr/Bx
321-2100	665564275	(NRR)* 25 dB, Blue Grips, Uncorded	100 Pr/Bx
321-2200	665574665	(NRR)* 25 dB, Assorted Color Grips, Uncorded	100 Pr/Bx



318-1000



3M™ E-A-R™ Push-Ins™ Earplugs

- » Soft, flexible foam conforms to the unique shape of each ear for comfortable noise reduction
- » Flexible stem makes insertion and removal cleaner and easier
- » Poly bag keeps earplugs clean before use



318-1001

ITEM #	ORDER #	DESCRIPTION	UOM
318-1000	665564225	(NRR)* 28 dB, Uncorded	100 Pr/Bx
318-1001	665564235	(NRR)* 28 dB, Corded	100 Pr/Bx
318-1002	665564245	(NRR)* 28 dB, Uncorded	200 Pr/Bx
318-1003	665573665	(NRR)* 28 dB, Corded	200 Pr/Bx

*The NRR may overestimate the hearing protection provided during typical use. 3M recommends reducing the NRR by 50% for estimating the amount of noise reduction provided. Noise Reduction Rating (NRR): dB CSA Class AL. Test compatible with 3M™ E-A-Rfit™ Validation System. 3M™ is Leading the Advancement of Hearing Conservation™.



Earplugs



391-0000



3M™ One Touch™ Pro Earplug Dispenser

- » Dispenser makes it easy for workers to access earplugs
- » A simple turn of the hand drops earplug into a worker's hand one at a time
- » Drained catch tray, wind side shields and durable plastic construction safeguards earplugs in outdoor locations
- » Versatile design allows for placing on countertops or wall mounting
- » Refill bottle not included

ITEM #	ORDER #	DESCRIPTION	UOM
391-0000	665542071	Earplug Dispenser	EA



312-1219



3M™ E-A-R™ TaperFit™ 2 Earplugs

- » Tapered earplugs fit easily and comfortably into ear canals
- » Earplugs roll down easily and then expands to block noise
- » Soft polyurethane foam conforms to the shape of the ear canal for a snug fit



312-1223

ITEM #	ORDER #	DESCRIPTION	UOM
312-1219	665564195	(NRR)* 32 dB, Uncorded, Regular Size	200 Pr/Bx
312-1223	665564445	(NRR)* 32 dB, Corded, Regular Size	200 Pr/Bx
312-1221	665520085	(NRR)* 32 dB, Uncorded, Large Size	200 Pr/Bx
312-1224	665564455	(NRR)* 32 dB, Corded, Large Size	200 Pr/Bx



3M™ E-A-Rsoft™ One Touch™ Earplug Refills

- » Refill container for One Touch™ dispenser
- » Uncorded earplugs
- » No packaging waste with each pair
- » Noise Reduction Rating (NRR)*: 33dB



391-1004

ITEM #	ORDER #	DESCRIPTION	UOM
391-1004	665564005	Regular Size, Yellow Neons™	500 Pr/Btl
391-1005	665572935	Large Size, Yellow Neons™	400 Pr/Btl
391-1010	665572255	Regular Size, Yellow Neon Blasts™	500 Pr/Btl



340-4002

340-4003



3M™ E-A-R™ UltraFit™ Earplugs

- » Premolded, triple flange earplugs fit comfortably in a wide range of ear sizes
- » No need to roll earplugs before fitting so the tips stay clean even if hands are dirty
- » Soft polymer is washable and reusable

ITEM #	ORDER #	DESCRIPTION	UOM
340-4002	665522775	(NRR)* 25 dB, Corded with Carrying Case	50 Pr/Bx
340-4003	665564285	(NRR)* 25 dB, Uncorded	100 Pr/Bx
340-4004	665522475	(NRR)* 25 dB, Corded	100 Pr/Bx

*The NRR may overestimate the hearing protection provided during typical use. 3M recommends reducing the NRR by 50% for estimating the amount of noise reduction provided. Noise Reduction Rating (NRR): dB CSA Class AL. Test compatible with 3M™ E-A-Rfit™ Validation System. 3M™ is Leading the Advancement of Hearing Conservation™.



Earplugs



1100



1110



3M™ 1100 and 1110 Foam Earplugs

- » Smooth, dirt resistant surface provides better hygiene
- » Earplugs are easy to roll down for quick and easy fitting
- » Tapered design fits comfortably in ear canals
- » Soft polyurethane foam is hypoallergenic

ITEM #	ORDER #	DESCRIPTION	UOM
1100	665511005	(NRR)* 29 dB, Uncorded	200 Pr/Bx
1110	665511045	(NRR)* 29 dB, Corded	100 Pr/Bx



P1300

P1301



3M™ E-A-R™ Skull Screws Earplugs

- » Tough look of threaded metal
- » Soft foam tips feel comfortable for extended wear
- » Cutting-edge look and comfort may increase worker compliance in wearing hearing protection
- » Push-to-fit style means no earplug roll-down is required for easy fitting

ITEM #	ORDER #	DESCRIPTION	UOM
P1300	665570235	(NRR)* 32 dB, Uncorded	120 Pr/Bx
P1301	665521895	(NRR)* 32 dB, Corded	120 Pr/Bx



P2000



P2001



3M™ No-Touch™ Foam Earplugs

- » Push-to-fit foam earplugs create a hygienic, noise-reducing seal
- » Push-to-fit style means no earplug roll down required
- » Foam is fused with the LiveWire stem, flexes sideways if impacted during wear
- » Foam tips stay clean, even when your hands are dirty

ITEM #	ORDER #	DESCRIPTION	UOM
P2000	665564415	(NRR)* 29 dB, Uncorded	100 Pr/Bx
P2001	665563895	(NRR)* 29 dB, Corded	100 Pr/Bx



P3000



P3001



3M™ Tri-Flange™ Earplugs

- » Triple-flanged, premolded earplugs fit comfortably in a wide range of ear sizes
- » Soft, flexible flanges conform to the shape of the ear canal for comfortable noise reduction
- » No need to roll earplugs before fitting so the tips stay clean even if hands are dirty

ITEM #	ORDER #	DESCRIPTION	UOM
P3000	665563965	(NRR)* 26 dB, Vinyl Corded	100 Pr/Bx
P3001	665521905	(NRR)* 26 dB, Cloth Corded	100 Pr/Bx

*The NRR may overestimate the hearing protection provided during typical use. 3M recommends reducing the NRR by 50% for estimating the amount of noise reduction provided. Noise Reduction Rating (NRR): dB CSA Class AL. Test compatible with 3M™ E-A-Rfit™ Validation System. 3M™ is Leading the Advancement of Hearing Conservation™.



Earplugs

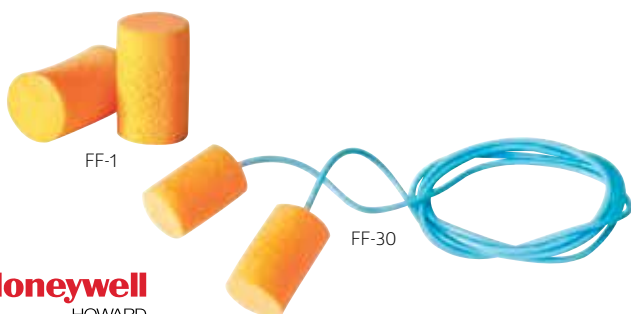

Honeywell
HOWARD
LEIGHT

FirmFit™ Disposable Earplugs

- » FirmFit™ is soft, exerts low expansion pressure on the ear canal
- » Excellent protection in most medium-to-high noise environments
- » Requires less pressure to roll down, slow recovery rate allows plenty of time to correctly insert in ear canal
- » Orange color makes compliance checks easy

ITEM #	ORDER #	DESCRIPTION	UOM
FF-1	341513915	(NRR) 30 dB, Uncorded	200 Pr/Bx
FF-30	341563965	(NRR) 30 dB, Corded	100 Pr/Bx



Honeywell
HOWARD
LEIGHT

Fusion® Reusable Earplugs

- » Patented dual-material design
- » FlexiFirm® stem is easy to grasp, ensuring easy insertion into the ear canal
- » SoftFlange™ creates comfortable seal in the ear canal for superior comfort and protection
- » Unique detachable nylon cord system adapts to virtually any application

ITEM #	ORDER #	DESCRIPTION	UOM
FUS30S-HP	341539515	(NRR) 27 dB, Corded, Size Small	100 Pr/Bx

Honeywell
HOWARD
LEIGHT

Laser Lite® Disposable Earplugs

- » Self-adjusting T-shape polyurethane foam expands easy insertion and wear
- » Smooth, soil-resistant closed cell-foam skin prevents dirt build-up
- » Formable foam expands to fit most wearers
- » High-visibility magenta and yellow colors make compliance checks quick and easy

ITEM #	ORDER #	DESCRIPTION	UOM
LL-1	341501475	(NRR) 32 dB, Uncorded	200 Pr/Bx
LL-30	341501495	(NRR) 32 dB, Corded	100 Pr/Bx
LL-1-D	341501485	(NRR) 32 dB, Uncorded	500 Pr/Bx



Honeywell
HOWARD
LEIGHT

Laser Trak® Metal Detectable Disposable Earplugs

- » Non-ferrous metal grommet and bright colors – easily detected by visual and automated inspection
- » Formable polyurethane foam expands to fit most wearers
- » Contoured T-shape for easy insertion and wear

ITEM #	ORDER #	DESCRIPTION	UOM
LT-30	341501665	(NRR) 33 dB, Corded	100 Pr/Bx





Earplugs



Max Lite® Disposable Earplugs

- » Ideal size for workers with smaller ear canals
- » Low pressure polyurethane foam expands gently for long-term wear
- » Contoured T-shape for easy handling and wear
- » Smooth, soil-resistant closed cell-foam skin prevents dirt build-up

ITEM #	ORDER #	DESCRIPTION	UOM
LPF-1	341501595	(NRR) 30 dB, Uncorded	200 Pr/Bx
LPF-30	341501615	(NRR) 30 dB, Corded	100 Pr/Bx
LPF-1-D	341501605	(NRR) 30 dB, Uncorded	500 Pr/Bx



MAX® Disposable Earplugs

- » Contoured bell shape is easy to insert
- » Contoured design easier to insert, resists tendency to back-out of ear canal
- » Polyurethane foam enhances comfort, especially for long-term wear
- » Smooth, soil-resistant closed cell-foam skin prevents dirt build-up

ITEM #	ORDER #	DESCRIPTION	UOM
Coral			
MAX-1	341501695	(NRR) 33 dB, Uncorded	200 Pr/Bx
MAX-30	341501735	(NRR) 33 dB, Corded	100 Pr/Bx

Red/White/Blue			
MAX-1-USA	341501725	(NRR) 33 dB, Uncorded	200 Pr/Bx
MAX-30-USA	341501755	(NRR) 33 dB, Corded	100 Pr/Bx

Coral			
MAX-1-D	341501705	(NRR) 33 dB, Uncorded	500 Pr/Bx

Small - Orange			
MAX-1S	341592425	(NRR) 30 dB, Uncorded, Small	200 Pr/Bx
MAX-30S	341563415	(NRR) 30 dB, Corded, Small	100 Pr/Bx



Quiet® Reusable Earplugs

- » Patented "no-roll" design is easy to handle and fit
- » Contoured shape comfortably matches contours of the ear canal
- » Smooth, non-irritating skin provides all-day comfort, easy to clean for long-term use
- » Built-in insertion stem makes insertion quick and easy

ITEM #	ORDER #	DESCRIPTION	UOM
QD1	341502045	(NRR) 26 dB, Uncorded	100 Pr/Bx
QD30	341502065	(NRR) 26 dB, Corded	100 Pr/Bx
QD30-RC	341502025	(NRR) 26 dB, Corded with Case	50 Pr/Bx





Honeywell
HOWARD
LEIGHT

Earplugs

Multi Max® Disposable Earplugs

- » Flexibility and protection in hearing protection with its two-sizes-in-one design
- » Improves individual fit while simplifying inventory
- » Smooth, soil-resistant closed cell-foam skin prevents dirt build-up
- » Formable polyurethane foam expands to fit most wearers



MM-1

ITEM #	ORDER #	DESCRIPTION	UOM
MM-1	341501785	(NRR) 31 dB, Uncorded	200 Pr/Bx

Honeywell
HOWARD
LEIGHT

AirSoft® Reusable Earplugs

- » Advanced air pocket design features internal noise-blocking fins
- » Four-flange profile creates better seal in the ear canal
- » Rounded flanges, tapered shape fits better in the ear canal
- » Firm stem facilitates easy insertion and removal



DPAS-1



AS-30R

ITEM #	ORDER #	DESCRIPTION	UOM
AS-30R	341501315	(NRR) 27 dB, Red Polycorded with Case	50 Pr/Bx
DPAS-30R	341501345	(NRR) 27 dB, Red Polycorded	100 Pr/Bx
DPAS-30W	341501365	(NRR) 27 dB, White Nylon Corded	100 Pr/Bx
DPAS-1	341501335	(NRR) 27 dB, Uncorded	100 Pr/Bx

Honeywell
HOWARD
LEIGHT

Banded Earplugs

- » Smooth, ergonomic pods fit in the ear for maximum protection
- » Patented band design prevents ear pods from touching dirty or contaminated surfaces
- » Lightweight and portable – designed especially for intermittent noise hazards
- » Includes pair of replacement pods

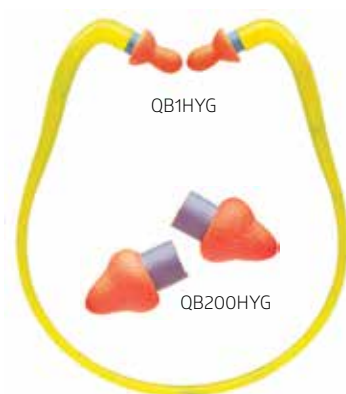

QB1HYG

QB200HYG

ITEM #	ORDER #	DESCRIPTION	UOM
QB1HYG	341501935	(NRR) 27 dB, Inner-Aural Fit	10 Pr/Bx
QB2HYG	341501955	(NRR) 25 dB, Supra-Aural Fit	10 Pr/Bx
QB3HYG	341501975	(NRR) 23 dB, Semi-Aural Fit	10 Pr/Bx
QB200HYG	341501965	QB2RHYG Replacement Pods	50 Pr/Bx

Honeywell
HOWARD
LEIGHT

SmartFit® Metal Detectable Reusable Earplugs

- » Conforming Material Technology™ adapts to the shape of the surrounding ear canal
- » Delivers superior comfort and a truly individual fit
- » Simplifies inventory control - a single product can fit almost every wearer
- » Blue color provides high visibility in detection
- » Metal ring on stem detectable by automated equipment



SDT-30

ITEM #	ORDER #	DESCRIPTION	UOM
SDT-30	341502105	(NRR) 25 dB, Corded	100 Pr/Bx



Earplugs

Honeywell
HOWARD
LEIGHT

SmartFit® Reusable Earplugs

- » Conforming Material Technology™ adapts to the shape of the surrounding ear canal
- » Delivers superior comfort and a truly individual fit
- » Simplifies inventory control - a single product fits almost every wearer
- » Detachable cord system and HearPack® storage case



SMF-30

ITEM #	ORDER #	DESCRIPTION	UOM
SMF-30	341502115	(NRR) 25 dB, Corded	100 Pr/Bx

Honeywell
HOWARD
LEIGHT

TrustFit® Pod Earplugs

- » Soft foam dimpled tip collapses to be easily and gently pushed into ear canal
- » No roll-down foam reduces hygiene concerns and makes for easy fit



TRUSTFITPOD-1



TRUSTFITPOD-30

ITEM #	ORDER #	DESCRIPTION	UOM
TRUSTFITPOD-1	341574665	(NRR) 28 dB, Uncorded	100 Pr/Pk
TRUSTFITPOD-30	341574675	(NRR) 28 dB, Corded	100 Pr/Pk

Honeywell
HOWARD
LEIGHT

Howard Light HL400 Earplug Dispenser

- » Durable plastic design is an economical choice for dispensing earplugs
- » Holds 400 pairs of Howard Leight™ disposable earplugs
- » Can be mounted to a wall or tabletop or can be free standing
- » Universal hole positions, eliminating the need to drill new holes.
- » Easy twist knob with 180° of access, makes dispensing earplugs easy
- » Supports all Howard Leight™ disposable earplugs: MAX®, MAX® Small, MAXLite®, Laser Lite®, FirmFit®, Multi Max®, and Xtreme®
- » Refills available as prefilled canisters and bags
- » 1/CS



HL400-LPF-INTRO

ITEM #	ORDER #	Description	UOM
HL400-MAX-INTRO	34158002	HL400 Dispenser with 1 prefilled canister of 400 prs. MAX earplugs	CS
HL400-LPF-INTRO	34158003	HL400 Dispenser with 1 prefilled canister of 400 prs. MAXLite earplugs	CS
HL400-LL-INTRO	34158004	HL400 Dispenser with 1 prefilled canister of 400 prs. Laser Lite earplugs	CS
HL400-FF-INTRO	34158005	HL400 Dispenser with 1 prefilled canister of 400 prs. FirmFit earplugs	CS
HL400-XTR-INTRO	34158007	HL400 Dispenser with 1 prefilled canister of 400 prs. X-TREME earplugs	CS
HL400-MM-INTRO	34158008	HL400 Dispenser with 1 prefilled canister of 400 prs. MultiMax earplugs	CS
HL400-MAXS-INTRO	34157936	HL400 Dispenser with 1 prefilled canister of 400 prs. MAX Small earplugs	CS



Earplugs

MOLDEX

Comets® Reusable Earplugs

- » Independently tested to ANSI S3.19-1974
- » Finger pocket makes Comets® easy to insert
- » Extra-soft material and an air-cushioned tip provide comfort
- » Triple flange adjusts to most size ear canals to hold the plug in place

ITEM #	ORDER #	DESCRIPTION	UOM
6490	222200505	(NRR) 25 dB, Uncorded	50 Pr/Bx
6495	222200515	(NRR) 25 dB, Corded	100 Pr/Bx



MOLDEX

Rockets® Reusable Earplugs

- » Independently tested to ANSI S3.19-1974
- » NRR 27 dB, with a new sound dampening additive
- » Easy-grip handle lets earplugs easily slip into ear
- » Air bubble in tip provides cushioned comfort
- » Earplugs can be washed and reused



6415

ITEM #	ORDER #	DESCRIPTION	UOM
6400	222200465	Uncorded w/ Pocket-Pak®	50 Pr/Bx
6404	222264045	Corded/Bagged	50 Pr/Bx
6405	222256905	Corded w/ Pocket-Pak®	50 Pr/Bx
6415	222256895	Metal Detectable, Corded/Bagged	50 Pr/Bx
6420	222200475	Cloth Cord w/ Pocket-Pak®	50 Pr/Bx
6480	222200485	Special Ops® Uncorded w/ Pocket-Pak®	50 Pr/Bx
6485	222200495	Special Ops®, Corded w/Pocket-Pak®	50 Pr/Bx



6420

MOLDEX

Jazz Band® Hearing Protector

- » NRR 25 dB, independently tested to ANSI S3.19-1974
- » Tapered foam pods, ideal choice for intermittent usage
- » Hangs easily around neck with optional breakaway cord
- » Alternative to earmuffs, does not interfere with eyewear

ITEM #	ORDER #	DESCRIPTION	UOM
6504	222265045	Pods w/ 1 Neck Cord, Kit	5 Pr/Bg
6506	222265065	Band, Cord and Pods	10 Pr/Bx



6504



6506

MOLDEX

Flip to Listen™ Dual Mode Reusable Earplugs

- » NRR 24 dB for noisy environments, NRR 4 when you need to hear
- » Independently tested to ANSI S3.19-1974
- » No need to remove earplugs with Flip Cap
- » Triple flange design provides comfort
- » Pocket-Pak® carrying case, optional cloth cord

ITEM #	ORDER #	DESCRIPTION	UOM
6770	222267705	Flip Cap, Corded	50 Pr/Bx



6770



Earplugs

MOLDEX

Goin' Green® Disposable Foam Earplugs

- » Independently tested to ANSI S3.19-1974, NRR 33 dB
- » Low-pressure foam for comfort and fit
- » Tapered shaped to fit small ear canals
- » Non-irritating smooth surface

ITEM #	ORDER #	DESCRIPTION	UOM
6620	222200575	Uncorded	200 Pr/Bx
6622	222200585	Corded	100 Pr/Bx
6646	222200615	PlugStation® Uncorded	250 Pr/Dsp
6647	222200625	PlugStation® Uncorded	500 Pr/Dsp

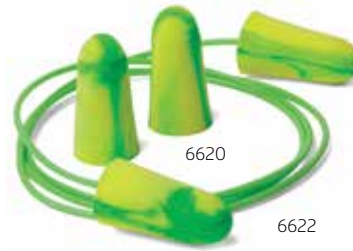

6646

MOLDEX

Pura-Fit® Disposable Foam Earplugs

- » Independently tested to ANSI S3.19-1974, NRR 33 dB
- » Hygienically packaged in biodegradable paper pouches
- » Softer foam, non-irritating smooth surface
- » Tapered, longer length for easy fitting

ITEM #	ORDER #	DESCRIPTION	UOM
6800	222268005	Uncorded	200 Pr/Bx
6900	222231035	Corded	100 Pr/Bx
6844	222200701	PlugStation® Uncorded	250 Pr/Dsp
6845	222268451	PlugStation® Uncorded	500 Pr/Dsp
6882	222268825	PlugStation® Corded	150 Pr/Dsp



6882

MOLDEX

Meteors® Disposable Foam Earplugs

- » Independently tested to ANSI S3.19-1974
- » Soft, slow recovery foam molds easily to the ear canal
- » Innovative undercut design affords a secure fit, all day long

ITEM #	ORDER #	DESCRIPTION	UOM
6630	222266305	(NRR) 28 dB, Small, Uncorded	200 Pr/Bx
6632	222266325	(NRR) 28 dB, Small, Corded	100 Pr/Bx
6870	222268705	(NRR) 33 dB, Uncorded	200 Pr/Bx
6970	222269705	(NRR) 33 dB, Corded	100 Pr/Bx
6634	222266345	(NRR) 28 dB, PlugStation® Small, Uncorded	250 Pr/Dsp
6875	222268755	(NRR) 33 dB, PlugStation® Uncorded	500 Pr/Dsp

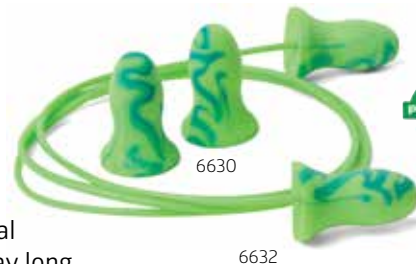

6875



Earplugs



6450



6455

MOLDEX

JETZ® Reusable Earplugs

- » NRR 27 dB, independently tested to ANSI S3.19-1974
- » Extra-soft material and triple flange design seals gently and snugly
- » Cloth cord locks securely to plug
- » Plugs can be washed and reused

ITEM #	ORDER #	DESCRIPTION	UOM
6450	222264505	Uncorded	50 Pr/Bx
6455	222264555	With Cord	50 Pr/Bx

MOLDEX

Softies® Disposable Foam Earplugs

- » Independently tested to ANSI S3.19-1974, NRR 33 dB
- » Radiant orange color for easy compliance checks
- » Extra-soft, low-pressure, non-irritating foam for comfort and fit
- » Tapered shape for easy insertion even for very small ear canals

ITEM #	ORDER #	DESCRIPTION	UOM
6600	222200535	Uncorded	200 Pr/Bx
6650	222200645	Corded	100 Pr/Bx



6600



6650



6604

6654

MOLDEX

SparkPlugs® Disposable Foam Earplugs

- » Independently tested to ANSI S3.19-1974, NRR 33 dB
- » Extra-soft, low-pressure, non-irritating foam for comfort and fit
- » Tapered shape for easy insertion even for very small ear canals
- » Random multi-color streaks and swirls design
- » 6615/6881 metal detectable versions, the plug and cord are independently detectable for safety

ITEM #	ORDER #	DESCRIPTION	UOM
6604	222200545	Uncorded	200 Pr/Bx
6654	222228235	Corded	100 Pr/Bx
6615	222266155	Metal Detectable, Corded	100 Pr/Bx

PlugStation®

6644	222200591	Uncorded	250 Pr/Dsp
6645	222200601	Uncorded	500 Pr/Dsp
6880	222268805	Corded	150 Pr/Dsp
6881	222268815	Metal Detectable, Corded	150 Pr/Dsp



6615



6645



6881



Earplugs



6820



6840



6846



6847



Mellows® Disposable Foam Earplugs

- » Independently tested to ANSI S3.19-1974, NRR 30 dB
- » Radiant orange color for easy compliance checks
- » Extra-soft, low-pressure, non-irritating foam for comfort and fit
- » Tapered shape for easy insertion even for very small ear canals



ITEM #	ORDER #	DESCRIPTION	UOM
6820	222268205	Uncorded	200 Pr/Bx
6840	222268405	Corded	100 Pr/Bx
6846	222268465	PlugStation® Uncorded	250 Pr/Dsp
6847	222268475	PlugStation® Uncorded	500 Pr/Dsp



6940



6945



6883



Glide® Foam Twist In Earplugs

- » Independently tested to ANSI S3.19-1974, NRR 30 dB
- » Unique multi-curved stem rotates for a custom fit
- » Large handle on curved stem for easy insertion and removal
- » Large soft foam pod for a comfortable, snug seal
- » Cord can be attached at any desired length



ITEM #	ORDER #	DESCRIPTION	UOM
6940	222269405	Uncorded	100 Pr/Bx
6945	222269455	With Cord	100 Pr/Bx
6883	22220003	PlugStation® with Cord	150 Pr/Dsp



Glide® Trio Reusable Earplugs

- » Independently tested to ANSI S3.19-1974, NRR 27 dB
- » Unique multi-curved stem rotates for a custom fit
- » Large handle on curved stem for easy insertion and removal
- » Soft triple flange plug can be washed and reused
- » Cord can be attached at any desired length



6445

ITEM #	ORDER #	DESCRIPTION	UOM
6445	222264455	With Cord	50 Pr/Bx

**3M****3M™ Model 1000 Earmuffs**

- » These lightweight earmuffs may be worn over-the-head, behind-the-head or under-the-chin
- » Large ear cup openings and soft, foam-filled cushions offer a snug, comfortable fit
- » Durable, lightweight construction of non-conductive, dielectric plastic
- » Noise Reduction Rating* NRR 20 dB (CSA class B) when the band is worn over-the-head. NRR 22 dB (CSA Class A) when the band is worn under-the-chin. NRR 22 dB (CSA Class B) when band is worn behind-the-head

ITEM #	ORDER #	DESCRIPTION	UOM
330-3001	665570081	One Size Fits Most	EA



330-3001



330-3002

3M**3M™ Model 3000 Earmuffs**

- » These lightweight earmuffs may be worn over-the-head, behind-the-head or under-the-chin
- » Large ear cup openings and soft, foam-filled cushions offer a snug, comfortable fit
- » Durable, lightweight construction of non-conductive, dielectric plastic
- » Noise Reduction Rating* NRR 25 dB (CSA class A) when the band is worn over-the-head. NRR 26 dB (CSA Class AL) when the band is worn under-the-chin. NRR 26 dB (CSA Class AL) when band is worn behind-the-head

ITEM #	ORDER #	DESCRIPTION	UOM
330-3002	665521591	One Size Fits Most	EA

3M**3M™ Peltor™ PTL™ Earmuffs**

- » Listening mode capability allows wearer to hear people talk or sounds without removing headset
- » In listening mode, amplified sounds are limited to 87 dB
- » Auto-switch returns earmuffs to normal hearing protection mode after 30 seconds
- » Ear cups with liquid and foam filled cushions

ITEM #	ORDER #	DESCRIPTION	UOM
H7A-PTL	665519711	(NRR)* 26 dB, Over-the-Head	EA



H7A-PTL



H7B

H7P3E

3M**3M™ Peltor™ Optime™ 101 Series Earmuffs**

- » Recommended for noise exposures up to 101 dBA
- » Stainless steel band distributes weight for low pressure fit
- » Ear cup pivot points tilt for comfort that adjusts to individual wearers
- » Liquid/foam filled earmuff cushions

ITEM #	ORDER #	DESCRIPTION	UOM
H7A	665570071	(NRR)* 27 dB, Over-the-Head	EA
H7B	665570211	(NRR)* 26 dB, Behind-the-Head	EA
H7P3E	665564431	(NRR)* 24 dB, Cap/Hard Hat Mounted	EA

*The NRR may overestimate the hearing protection provided during typical use. 3M™ recommends reducing the NRR by 50% for estimating the amount of noise reduction provided. 3M™ is Leading the Advancement of Hearing Conservation™.



Earmuffs

3M

3M™ Peltor™ X Series Earmuffs

- » Lightweight, low-profile earmuff designed for protection against low-level industrial noise and other loud sounds
- » Features an electrically insulated wire headband, often referred to as “dielectric”
- » Wire headband offers consistent pressure over prolonged wearing periods
- » Ear cup pivot points tilt for optimum comfort and efficiency

ITEM #	ORDER #	DESCRIPTION	UOM
X1A	665510071	(NRR)* 22 dB, Over-the-Head	EA
X2A	665510731	(NRR)* 24 dB, Over-the-Head	EA
X3A	665511181	(NRR)* 28 dB, Over-the-Head	EA
X4A	665511281	(NRR)* 28 dB, Low-Profile, Over-the-Head	EA
X5A	665511961	(NRR)* 31 dB, Over-the-Head	EA
X5P3E	665521801	(NRR)* 31 dB, Cap/Hard Hat Mounted	EA



H10A

3M

3M™ Peltor™ Optime™ 105 Series Earmuffs

- » Effective hearing protection for noise exposures up to 105dBA
- » Double-shell technology boosts its noise blocking ability
- » Durable stainless steel band resists bending and warping
- » Patented Twin-Cup™ design has soft, foam-filled earmuff cushions

ITEM #	ORDER #	DESCRIPTION	UOM
H10A	665564031	(NRR)* 30 dB, Over-the-Head	EA
H10B	665570291	(NRR)* 29 dB, Behind-the-Head	EA
H10P3E	665522721	(NRR)* 27 dB, Cap/Hard Hat Mounted	EA
H10AHV	665570111	(NRR)* 30 dB, Hi-Viz Over-the-Head	EA

3M

3M™ Peltor™ Optime™ 95 Series Earmuffs

- » Earmuff provide hearing protection against high-frequency noise up to 95 dBA
- » Ultra-light with liquid/foam filled hearing protectors are less noticeable to wear
- » Stainless steel band resists bending and warping
- » Ear cup pivot points tilt for optimum comfort and efficiency

ITEM #	ORDER #	DESCRIPTION	UOM
H6A/V	665570121	(NRR)* 21 dB, Over-the-Head	EA
H6B/V	665570131	(NRR)* 21 dB, Behind-the-Head	EA
H6F/V	665521581	(NRR)* 21 dB, Over-the-Head w/ Folding Cups	EA



H6A/V



H9A

3M

3M™ Peltor™ Optime™ 98 Series Earmuffs

- » Recommended for noise exposures up to 98 dBA
- » Ultra-light with liquid/foam filled earmuff cushions
- » Stainless steel headband distributes weight for low pressure fit
- » Ear cup pivot points tilt for comfort that adjusts to individual wearers

ITEM #	ORDER #	DESCRIPTION	UOM
H9A	665564061	(NRR)* 25 dB, Over-the-Head	EA
H9P3E	665564051	(NRR)* 23 dB, Cap/Hard Hat Mounted	EA

*The NRR may overestimate the hearing protection provided during typical use. 3M™ recommends reducing the NRR by 50% for estimating the amount of noise reduction provided. 3M™ is Leading the Advancement of Hearing Conservation™.



Earmuffs



3M™ Peltor™ WS™ ProTac™ XP Headset

- » Voice microphone includes VOX (Voice Operated Transmit) for hands-free communication
- » DSP (Digital Noise Reduction) provides clear wireless and wired communication
- » Supports Bluetooth® A2DP profile for streaming high quality stereo sound
- » High attenuation for hearing protection in noisy environments
- » External Jacket for optional 2-Way radio connectivity



MT15H7AWS5-77



MT15H7BWS5-77

ITEM #	ORDER #	DESCRIPTION	UOM
MT15H7P3EWS5-77	665536131	(NRR)* 26 dB, Cap/Hard Hat Mounted	EA
MT15H7BWS5-77	665541811	(NRR)* 27 dB, Behind-the-Head	EA



3M™ Peltor™ ProTac™ III Headset

- » Professional-quality hearing protection
- » Environmental microphones for level-dependent hearing protection and ambient listening
- » 3.5 mm listen-only stereo input (limited to 82 dB) for connection to external devices (e.g. cell phone, two-way radio, Ipod)
- » Voice guided menu system to prevent you from taking the headset off
- » Auto power off after 4 hours of non-use and audible low-battery warning



MT13H220A



MT13H221P3E

ITEM #	ORDER #	DESCRIPTION	UOM
MT13H220A	665541821	(NRR)* 21 dB, Slim, Over-the-Head	EA
MT13H220P3E	665541831	(NRR)* 19 dB, Slim, Cap/Hard Hat Mounted	EA
MT13H221A	665541841	(NRR)* 26 dB, Over-the-Head	EA
MT13H221P3E	665541861	(NRR)* 23 dB, Cap/Hard Hat Mounted	EA



HRXS221A-NA



3M™ Peltor™ WorkTunes™ Pro AM/FM Headset

- » Professional-quality hearing protection
- » AM/FM Radio headset with built in antenna, with 5 presets
- » 3.5 mm listen only stereo input (limited to 82 dB) for connection to external devices (e.g. cell phone, two-way radio, Ipod)
- » Auto power off after 4 hours of non-use and audible low-battery warning

ITEM #	ORDER #	DESCRIPTION	UOM
HRXS221P3E-NA	665538401	(NRR)* 23 dB, Cap/Hard Hat Mounted	EA

*The NRR may overestimate the hearing protection provided during typical use. 3M™ recommends reducing the NRR by 50% for estimating the amount of noise reduction provided. 3M™ is Leading the Advancement of Hearing Conservation™.



Earmuffs



1035110-VS

Honeywell
HOWARD
LEIGHT

1035121-VS



1035114-VS

VeriShield™ 100 Series Passive Earmuffs

- » Large dimension range: Comfortably fits a wide range of head sizes. 17% more adjustable than earlier versions.
- » Wide cup opening: Ideal for workers with larger ears, or who wear hearing aids. Opening area of the cup increased by 16% over earlier versions.
- » Lightweight cushioned headband: Steel-wire construction with padded headband and precision micro adjustments designed for just the right fit around the ear.
- » Memory foam ear cushions: New unique memory foam that combines denser and softer foam than previous models, for greater comfort and attenuation. Reduces squeezing pressure on the head and enhances comfort.
- » Air Flow Control Technology

ITEM #	ORDER #	DESCRIPTION	UOM
Over-the-Head			
1035100-VS	341580631	(NRR) 24 dB, VS110 VeriShield Earmuff	EA
1035102-VS	341580611	(NRR) 24 dB, VS110F VeriShield Folding Earmuff	EA
1035104-VS	341580601	(NRR) 26 dB, VS120 VeriShield Earmuff	EA
1035106-VS	341580591	(NRR) 27 dB, VS120FHV VeriShield Hi-Viz Folding Earmuff	EA
1035108-VS	341580581	(NRR) 30 dB, VS130 VeriShield Earmuff	EA
1035110-VS	341580571	(NRR) 30 dB, VS130HV VeriShield Hi-Viz Earmuff	EA
Behind-the-Neck			
1035112-VS	341580561	(NRR) 22 dB, VS110N VeriShield Earmuff Neckband	EA
1035114-VS	341580551	(NRR) 25 dB, VS120N VeriShield Earmuff Neckband	EA
1035116-VS	341580541	(NRR) 28 dB, VS130N VeriShield Earmuff Neckband	EA
Hard Hat			
341580531	1035118-VS	(NRR) 21 dB, VS110H VeriShield Helmet Earmuff	EA
341580621	1035121-VS	(NRR) 24 dB, VS120H VeriShield Helmet Earmuff	EA
341580521	1035124-VS	(NRR) 27 dB, VS130H VeriShield Helmet Earmuff	EA
341580511	1035127-VS	(NRR) 27 dB, VS130HHV VeriShield Helmet Earmuff Hi-Viz	EA



Earmuffs

Honeywell
HOWARD
LEIGHT

QM24+® Earmuffs

- » Dielectric, usable in work environments with electricity
- » Lightweight, makes all-day wear more comfortable
- » Broad ear cushions, comfort for all sizes and headband positions

ITEM #	ORDER #	DESCRIPTION	UOM
QM24+	341502081	(NRR) 25 dB	EA



Honeywell
HOWARD
LEIGHT

Thunder® Earmuffs

- » Air Flow Control™ Technology provides consistent attenuation, at low frequencies
- » Dielectric construction suitable for electrical environments
- » Uniform headband pressure for all head sizes
- » Quick-Click height adjustment remains fixed during wear
- » Snap-in ear cushions make replacement quick and easy

ITEM #	ORDER #	DESCRIPTION	UOM
Headband			
1010970-H5	341536791	(NRR) 30 dB, T3, Black	EA
Cap/Hard Hat Mounted			
1011601	341500541	(NRR) 23 dB, T1H, Light Green	EA





Earmuffs



6135

6120



MX-5 and MX-6 Earmuffs

- » Soft cushion-ribbed open-air headband
- » Over molded headband is durable, rugged
- » Lightweight wire frame allows easy cup adjustment
- » Extra soft foam/low pressure large ear cushions

ITEM #	ORDER #	DESCRIPTION	UOM
Earmuffs			
6120	222261201	(NRR) 27 dB, MX-5	EA
6130	222261301	(NRR) 30 dB, MX-6	EA

Hygiene Kits

6125	222261251	For MX-5	EA
6135	222261351	For MX-6	EA



6140



MX-7 Cap Mounted Earmuff

- » Slots into almost all hard hats
- » Lightweight wire frame allows easy cup adjustment
- » Larger cup openings are designed to fit most ear sizes
- » Exclusive waffled cup foam/low pressure large ear cushions

ITEM #	ORDER #	DESCRIPTION	UOM
6140	22220020	(NRR) 28 dB	10 Bx/Cs



6100



M1 Premium Earmuffs

- » SoftCoat® covering on the cups helps muffle transmitted noise
- » Black-chrome, spring-steel band that doesn't twist out of shape
- » Six different adjustment points provide fit for most head sizes
- » Folds for easy storage into compact size

ITEM #	ORDER #	DESCRIPTION	UOM
6100	222261001	(NRR) 29 dB	EA



6200



M2 Multi-Position Earmuffs

- » SoftCoat® covering on the cups and yoke helps muffle transmitted noise
- » Cup adjustment is infinitely variable
- » Lightweight plastic headband
- » Molded grips for easy and quick fitting

ITEM #	ORDER #	DESCRIPTION	UOM
6200	222262001	(NRR) 26 dB	EA



Disposable



5201



3M™ Half Facepiece Respirators 5000 Series, Disposable

- » NIOSH approved for respiratory protection against certain organic vapors, acid gases or particulates
- » Multi-purpose respirator assembly works in a variety of workplace applications
- » Half face piece design is ideal for intermittent use
- » Disposable model helps reduce maintenance issues for greater convenience

ITEM #	ORDER #	DESCRIPTION	UOM
5201	665512621	Respirator Assembly with Organic Vapor, Medium	EA
5301	665513231	Respirator Assembly with Organic Vapor, Large	EA
5203	665512631	Respirator Assembly Organic Vapor/Acid Gas, Medium	EA
5303	665513241	Respirator Assembly with Organic Vapor/Acid Gas, Large	EA
52P71	665512211	Respirator Assembly with Organic Vapor/ P95, Medium	EA
53P71	665513221	Respirator Assembly with Organic Vapor/ P95, Large	EA



9211+



3M™ Aura™ Particulate Respirator 9211+ N95

- » Three-panel disposable flat-fold respirator features soft inner material and 3M™ Cool Flow™ Valve to help provide comfortable, reliable worker respiratory protection
- » Ideally suited for work settings that involve heat, humidity, or long periods of wear
- » Can also be used to help reduce inhalation of certain airborne biological particles
- » Does not contain components made from natural rubber latex to help prevent reactions from users with latex sensitivities or restrictions
- » Individual packaging and flat fold design provides convenient storage and portability

ITEM #	ORDER #	DESCRIPTION	UOM
9211+	66559213	Disposable Flat-Fold Particulate Respirator	120/Cs



8110S



3M™ Particulate Respirators, N95

- » This disposable N95 particulate respirator is designed to help provide comfortable, reliable worker respiratory protection against certain non-oil based particles
- » 3M incorporates proprietary technology with advanced electrostatically charged microfiber filter media, designed for ease of breathing
- » Cushioning nose foam and adjustable nose clip helps provide a custom fit and secure seal
- » Can also be used to help reduce inhalation of certain airborne biological particles
- » NIOSH-approved



8200

8511

ITEM #	ORDER #	DESCRIPTION	UOM
8110S	665514525	Particulate Respirator	20/Bx
8200	665519365	Particulate Respirator	20/Bx
8210	665501755	Particulate Respirator	20/Bx
8210Plus	665514535	Particulate Respirator	20/Bx
8211	665514545	Particulate Respirator	10/Bx
8511	665585115	N95 Dust Mask	10/Bx



Disposable



3M™ Particulate Respirator with 3M™ Cool Flow™ Valve, N95

- » N95 approved filtering face piece particulate respirator
- » 3M™ Cool Flow™ Exhalation Valve
- » Compatible with a variety of protective eyewear and hearing protection
- » Cushioning nose foam
- » Adjustable nose clip helps provide a custom fit and secure seal



8210V

ITEM #	ORDER #	DESCRIPTION	UOM
8210V	665582235	Particulate Respirator with Cool Flow™ Valve	10/Bx



8233



3M™ Particulate Respirator 8233, N100

- » NIOSH's highest rated filtration efficiency in a disposable respirator N100
- » 3M™ Cool Flow™ Exhalation Valve reduces heat build-up inside the respirator
- » Compatible with a variety of protective eyewear and hearing protection
- » Adjustable nose clip reduces potential for eyewear fogging
- » Individually packaged
- » Advanced electrostatic media is designed for ease of breathing

ITEM #	ORDER #	DESCRIPTION	UOM
8233	665582331	Particulate Respirator N100	EA



3M™ Particulate Respirators, R95

- » NIOSH R95 approved
- » Economical filtering facepiece particulate respirator
- » Collapse resistant shell for increased durability
- » Compatible with a variety of protective eyewear and hearing protection
- » Adjustable nose clip reduces potential for eyewear fogging and helps ensure a better seal and fit
- » Two-strap design helps provide a secure fit



8240

ITEM #	ORDER #	DESCRIPTION	UOM
8240	665514565	Particulate Respirator	20/Bx
8246	665514575	With Carbon Layer to Reduce Nuisance Levels of Acid Gases	20/Bx
8247	665514585	With Carbon Layer to Reduce Nuisance Levels of Organic Vapors	20/Bx



Disposable

3M

3M™ Particulate Respirator with 3M™ Cool Flow™ Valve, P95

- » NIOSH approved for at least 95% filtration efficiency against certain oil and non-oil based particles
- » Braided headbands help provide a comfortable and secure seal
- » Adjustable M-nose clip adjusts easily for fewer pressure points
- » 3M™ Cool Flow™ Exhalation Valve helps reduce heat build-up inside the respirator
- » Advanced Electrostatic Media is designed for ease of breathing
- » Helps protect against certain non-oil based particles



8271

ITEM #	ORDER #	DESCRIPTION	UOM
8271	665514595	Particulate Respirator	10/Bx
8577	665514675	With Carbon Layer to Reduce Nuisance Levels of Organic Vapors	10/Bx
8576	665514665	With Carbon Layer to Reduce Nuisance Levels of Acid Gases	10/Bx

3M

3M™ Particulate Welding Respirators, N95 with Face Seal



8212

- » NIOSH approved for at least 95% filtration efficiency against certain non-oil based particles
- » Flame resistant per modified ASTM D2859 (not a substitute for a faceshield)
- » Recommended for welding and operations in which metal fumes may be present
- » Cake resistant filter layers reduce the caking of particles on the respirator surface
- » Adjustable nose clip reduces potential for eyewear fogging
- » 3M™ Cool Flow™ Exhalation Valve reduces heat build-up inside the respirator
- » Advanced Electrostatic Media is designed for ease of breathing

ITEM #	ORDER #	DESCRIPTION	UOM
8212	665582145	Particulate Welding Respirator	10/Bx
8214	665582155	With Carbon Filter Layer to Reduce Exposure to Ozone/Nuisance Level of Organic Vapors	10/Bx

3M

3M™ Particulate Welding Respirators, N95

- » N95 approved filtering facepiece particulate respirator for certain non-oil based particles
- » Flame resistant per modified ASTM D2859 (not a substitute for a faceshield)
- » Recommended for welding and operations in which metal fumes may be present
- » Cake resistant filter layers reduce the caking of particles on the respirator surface
- » Soft nose foam; adjustable noseclip and straps
- » 3M™ Cool Flow™ Exhalation Valve reduces heat build-up inside the respirator



8512

ITEM #	ORDER #	DESCRIPTION	UOM
8512	665514625	Particulate Welding Respirator	10/Bx
8514	665514635	With Carbon Filter Layer Reduces Exposure to Nuisance Level Odors	10/Bx
8515	665514645	Economical Particulate Welding Respirator	10/Bx



Disposable



3M™ VFlex™ Particulate Respirators, N95

- » Economical N95 disposable particulate respirator
- » 3M™ proprietary filter media and V-shaped pleats helps make breathing easier
- » Flat-fold design allows for convenient storage prior to use
- » Adjustable nose clip helps provide a custom fit and secure seal
- » Uniquely designed tabs for respirator positioning on the face
- » Pleats flex with mouth movement while talking
- » Spacious inside with comfortable inner layer



9105S

ITEM #	ORDER #	DESCRIPTION	UOM
9105S	665591075	Small, VFlex™ Particulate Respirator	50/Bx
9105	665591065	VFlex™ Particulate Respirator	50/Bx



8293



3M™ Particulate Respirator 8293, P100

- » P100 Approved, NIOSH's highest rated filtration efficiency in a filtering facepiece respirator
- » 3M™ Cool Flow™ Valve keeps wearer cool
- » Individually packaged
- » Comfortable face seal
- » Adjustable buckle straps help provide a secure fit
- » Adjustable nose clip reduces potential for eyewear fogging and helps ensure a better seal and fit

ITEM #	ORDER #	DESCRIPTION	UOM
8293	665514601	Particulate Respirator	EA



4600 Series AirWave® N95 Disposable Respirator with SmartStrap®

- » Cool and comfortable SmartStrap allows respirator to hang around the neck when not in use
- » Exclusive easy-breathing wave design means more airflow
- » FlexFit® design moves easily with your face and stays in place
- » Pinch-free molded nose bridge with soft foam
- » Softspun® lining for increased comfort
- » Dura-Mesh® shell resists collapsing in heat and humidity
- » Metal-free
- » Meets heat and flame resistance in accordance with ANSI/ISEA 110-2003 Section 7.11.1

ITEM #	ORDER #	DESCRIPTION	UOM
4601 N95	22224601	Small	100/Cs
4600 N95	222260955	Medium/Large	10/Bx



4600 N95



Disposable

MOLDEX

4200 Series AirWave® N95 Disposable Respirator

- » Exclusive easy-breathing wave design means more airflow
- » FlexFit® design moves easily with your face and stays in place
- » Pinch-free molded nose bridge with soft foam
- » Softspun® lining for increased comfort
- » Dura-Mesh® shell resists collapsing in heat and humidity
- » Meets heat and flame resistance in accordance with ANSI/ISEA 110-2003 Section 7.11.1



ITEM #	ORDER #	DESCRIPTION	UOM
4201 N95	222242015	Small	10/Bx
4200 N95	222242005	Medium/Large	10/Bx

MOLDEX

Dirt Dawgs® N95 Disposable Respirator

- » 100% PVC-Free
- » Dura-Mesh® shell resists collapsing in heat and humidity
- » Molded nose bridge seals easily without a metal noseband and straps are securely attached
- » Softspun® lining for increased comfort and durability
- » NIOSH certified to have a filter efficiency of 95% or greater for non-oil based particulates
- » Meets heat and flame resistance in accordance with ANSI/ISEA 110-2003 Section 7.11.1 and Certified under 42CFR84



ITEM #	ORDER #	DESCRIPTION	UOM
1200N95	222220955	Medium/Large	20/Bx

MOLDEX

2360P100 Series P100 Disposable Respirator

- » 100% PVC-Free
- » Adjustable cloth straps assure a snug, cool and comfortable fit
- » Ventex® valve lets the hot air out faster so workers breathe easier and stay cooler
- » Soft foam face cushion for added comfort and no pressure points
- » Dura-Mesh® shell resists collapsing in heat and humidity
- » Contour molded nose bridge seals without a metal noseband
- » 99.97% efficient against oil and non-oil based particulates
- » Meets heat and flame resistance in accordance with ANSI/ISEA 110.2003 Section 7.11.1



ITEM #	ORDER #	DESCRIPTION	UOM
2360P100	222200285	Medium/Large	5/Bg



Disposable

MOLDEX

Standard N95 Series 2-Strap Respirators

- » 100% PVC-Free
- » Dura-Mesh® shell resists collapsing in heat and humidity
- » Molded nose bridge seals easily without a metal noseband and straps are securely attached
- » Softspun® lining for increased comfort and durability
- » Soft foam nose cushion for added comfort
- » Meets heat and flame resistance in accordance with ANSI/ISEA 110-2003 Section 7.11.1



2200N95

2300N95

ITEM #	ORDER #	DESCRIPTION	UOM
2200N95	222205555	Medium/Large	20/Bx
2201N95	222205565	Small	20/Bx
2207N95	222200215	Low Profile	20/Bx
2300N95	222200955	Medium/Large with Exhale Valve	10/Bx
2301N95	222201955	Small with Exhale Valve	10/Bx
2307N95	222200255	Low Profile with Exhale Valve	10/Bx
2400N95	222204525	With Ozone/Organic Vapors Filter Layer, Medium/Large with Exhale Valve	10/Bg
2500N95	222225005	With Organic Vapor/Acid Gas Filter Layer, Medium/Large with Exhale Valve	10/Bg



4300P95

MOLDEX

4300 Series AirWave® P95 Disposable Respirator

- » 100% PVC-Free
- » Exclusive easy-breathing wave design
- » NIOSH approved 95% efficient against oil and non-oil based particulates
- » FlexFit® design moves easily with your face and stays in place
- » Dura-Mesh® shell resists collapsing in heat and humidity
- » Soft, cloth SmartStrap® is both hangable and adjustable
- » Foam face cushion for added comfort and no pressure points
- » Metal-free
- » Meets heat and flame resistance in accordance with ANSI/ISEA 110-2003 Section 7.11.1

ITEM #	ORDER #	DESCRIPTION	UOM
4300P95	222230955	Medium/Large	8/Bx

MOLDEX

4700 Series AirWave® N100 Disposable Respirator

- » 100% PVC-Free
- » Exclusive easy-breathing wave design
- » 99.97% efficient against non-oil based particulates
- » Ventex® valve lets the hot air out faster so workers breathe easier and stay cooler
- » FlexFit® design moves easily with your face and stays in place
- » Dura-Mesh® shell resists collapsing in heat and humidity
- » Soft, cloth SmartStrap® is both hangable and adjustable
- » Foam face cushion for added comfort and no pressure points
- » Softspun® lining for increased comfort and durability
- » Metal-free
- » Meets heat and flame resistance in accordance with ANSI/ISEA 110-2003 Section 7.11.1

ITEM #	ORDER #	DESCRIPTION	UOM
4700N100	222271045	Medium/Large	5/Bx



4700N100



Disposable



4800 Series AirWave® N95 Disposable Respirator

- » 100% PVC-Free
- » Can be used against most welding fumes
- » Added carbon layer helps filter out nuisance ozone and organic vapors
- » Soft foam full flange for ultimate comfort
- » Adjustable cool cloth SmartStrap® for a custom fit
- » Softspun® lining for increased comfort and durability
- » Exclusive Dura-Mesh® shell resists collapsing in heat and humidity
- » Meets heat and flame resistance in accordance with ANSI/ISEA 110-2003 Section 7.11.1

ITEM #	ORDER #	DESCRIPTION	UOM
4800 N95	222248005	Medium/Large	8/Bx



4800 N95



R95 Disposable Respirators with HandyStrap®

- » 100% PVC-Free
- » Ventex® valve lets the hot air out faster so workers breathe easier and stay cooler
- » R95 protection against both oil and non-oil based particulate aerosols
- » Soft foam full flange for ultimate comfort
- » HandyStrap® with buckle, allows mask to hang down around the user's neck when not in use
- » Softspun® lining for increased comfort and durability
- » Exclusive Dura-Mesh® shell resists collapsing in heat and humidity
- » Meets heat and flame resistance in accordance with ANSI/ISEA 110-2003 Section 7.11.1



2740R95

ITEM #	ORDER #	DESCRIPTION	UOM
2740R95	222227405	Medium/Large	10/Bx
2840R95	222200375	With Ozone/Organic Vapors Filter Layer, Medium/Large	10/Bx
2940R95	222200405	With Organic Vapor/Acid Gas Filter Layer, Medium/Large	10/Bx



N95 Particulate Respirators with HandyStrap®

- » 100% PVC-Free
- » HandyStrap® with buckle, allows mask to hang down around the user's neck when not in use
- » Cloth HandyStrap® feels cool and comfortable
- » Soft foam nose cushion for added comfort and no pressure points
- » Softspun® lining for increased comfort and durability
- » Exclusive Dura-Mesh® shell resists collapsing in heat and humidity



2600N95

2700N95

2800N95

ITEM #	ORDER #	DESCRIPTION	UOM
2600N95	222271455	Medium/Large	15/Bx
2700N95	222200305	With Ventex® Valve, Medium/Large	10/Bx
2800N95	222200355	With Ventex® Valve, Ozone/Organic Vapors Filter Layer, Medium/Large	10/Bx



Disposable

MOLDEX

2730N100 Series N100 Disposable Respirator with HandyStrap®

- » 100% PVC-Free
- » HandyStrap® with buckle, allows mask to hang down around the user's neck when not in use
- » Ventex® valve lets the hot air out faster so workers breathe easier and stay cooler
- » Dura-Mesh® shell resists collapsing in heat and humidity
- » Foam face cushion for added comfort and no pressure points
- » Softspun® lining for increased comfort and durability
- » Meets heat and flame resistance in accordance with ANSI/ISEA 110-2003 Section 7.11.1

ITEM #	ORDER #	DESCRIPTION	UOM
2730N100	222200325	Medium/Large	5/Bx



2730N100

MOLDEX

N99 Welding Disposable Respirators

- » 100% PVC-Free
- » NIOSH certified to have a filter efficiency of 99% or greater against particulate aerosols free of oil
- » Exhale valve lets workers breathe easy and stay cool
- » Exclusive Dura-Mesh® shell resists collapsing in heat and humidity
- » Softspun® lining for increased comfort and durability
- » Fits easily under welding hoods
- » Soft foam nose seal for a comfortable fit
- » Meets heat and flame resistance in accordance with ANSI/ISEA 110-2003 Section 7.11.1



2310 N99

ITEM #	ORDER #	DESCRIPTION	UOM
2310 N99	222210995	With Standard Straps, Medium/Large	10/Bg
2315 N99	222200265	With Adjustable Straps, Medium/Large	10/Bg

MOLDEX

Respirator Locker®

- » 100% PVC-Free
- » Holds four 2800N95 Plus Nuisance OV Masks
- » Provides each worker with hygienic storage and a personal supply of respirators
- » Allows employer to monitor respirator usage, reducing costs
- » Reduces time spent getting new respirators
- » Separate chamber stores used respirator during breaks
- » Meets heat and flame resistance in accordance with ANSI/ISEA 110-2003 Section 7.11.1



2850N95

ITEM #	ORDER #	DESCRIPTION	UOM
2850N95	222200395	Holds Four 2800N95 Plus Nuisance OV Masks, Medium/Large	4/Bx



Disposable



Vending Packs of Disposable Respirators

- » For use in vending applications
- » 100% PVC-Free
- » Meets heat and flame resistance in accordance with ANSI/ISEA 110-2003 Section 7.11.1

ITEM #	ORDER #	DESCRIPTION	UOM
2200V	22220069	Vend Pack of 2200N95 Respirator	50/Cs
2300V	22220072	Vend Pack of 2300N95 Respirator	40/Cs
2310V	22220102	Vend Pack of 2310N99 Respirator	40/Cs
2400V	22220106	Vend Pack of 2400N95 Respirator	40/Cs
2700V	22220109	Vend Pack of 2700N95 Respirator	40/Cs
2800V	22220115	Vend Pack of 2800N95 Respirator	40/Cs
4200V	22220116	Vend Pack of 4200N95 Respirator	40/Cs
4800V	22220117	Vend Pack of 4800N95 Respirator	40/Cs



2300V



ONE-Fit Molded Cup N95 Respirators

- » Strong and rigid outer shell prevents mask from collapse in high humidity or moist environments
- » Form-fitted mask contours with the natural shape of the face, minimizing pressure points
- » Dual welded head straps keeps the respirator comfortably on the user's face
- » Latex-free, hypo-allergenic for users with sensitive skin
- » NIOSH Certification - 95% against solid particulates & non-petroleum based liquid aerosols



14110444



14110445

ITEM #	ORDER #	DESCRIPTION	UOM
14110444	341557865	Molded Cup N95 Particulate Respirator	20/Bx
14110445	341560905	Molded Cup N95 Particulate Respirator w/ Exhalation Valve	10/Bx



SAF-T-Fit Plus Disposable Particulate Respirators

- » Molded cup design
- » Offered in valved and non-valved
- » Incorporates humidity-resistant filter media
- » Low breathing resistance
- » Lightweight design
- » Durable suspension straps
- » Optional boomerang nose seal or full-face seal for secure and comfort fit
- » Latex-free
- » NIOSH approved



14110391

14110440

ITEM #	ORDER #	DESCRIPTION	UOM
14110391	341523215	N95 Molded Cup Particulate Respirator w/Boomerang Nose Seal, Medium/Large	20/Bx
14110394	341523235	N95 Molded Cup Particulate Respirator w/Boomerang Nose Seal & Valve, Medium/Large	20/Bx
14110440	341523341	P100 Molded Cup Particulate Respirator w/Full Face Seal & Valve, Medium/Large	EA



Disposable



PeakFit® Particulate Respirators

- » Large, contoured design facilitates breathing
- » Molded nose bridge, with no metal nosepiece
- » Internal nose cushion, made with a soft, closed-cell foam
- » Extra soft, polypropylene inner lining
- » Latex-free, integrated one-piece cloth head strap
- » Adjustable head strap buckle
- » Available with an exhalation vent that reduces hot air buildup
- » NIOSH approved N95 level protection



80102V



80105A

ITEM #	ORDER #	DESCRIPTION	UOM
80102V	323301025	Vented Particulate Respirator	10/Bx
80105A	323311055	Unvented AG Particulate Respirator	20/Bx



N95 Particulate Respirators

- » 95% filter efficiency level effective against particulate aerosols free of oil; time use restrictions may apply
- » Maintenance-free construction
- » Adjustable nose bridge with foam strip to reduce the potential for eyewear to fog
- » Latex-free stapled fixed head strap
- » NIOSH approved



8611

ITEM #	ORDER #	DESCRIPTION	UOM
8610	G73586105	N95 Particulate Respirator	20/Bx
8611	G73586115	N95 Valved Particulate Respirator	10/Bx

GERSON®

Low-Profile N95 Respirator

- » This mask is cleared by the FDA for use in surgical environments, Made in USA
- » Electrostatically-charged filter media provides low breathing resistance
- » Latex-free, staple-free head straps for comfort and safety
- » Soft foam nose cushion
- » More durable, double-shell construction for long life and economy
- » NIOSH Approved



1730

ITEM #	ORDER #	DESCRIPTION	UOM
1730	422300045	N95 Particulate Respirator	20/Bx



Disposable

GERSON®



1740

Low-Profile N95 Respirator with Exhalation Valve

- » Premium oversized valve opens more easily to expel hot air for cool comfort, Made in USA
- » Electrostatically-charged filter media provides low inhalation breathing resistance
- » Latex-free, staple-free head straps for comfort and safety
- » Soft foam nose cushion
- » More durable, double-shell construction for long life and economy
- » NIOSH Approved

ITEM #	ORDER #	DESCRIPTION	UOM
1740	422300055	N95 Particulate Respirator w/Valve	10/Bx

GERSON®

N95 Particulate Respirator w/OV-AG Nuisance Relief

- » Layer of activated carbon provides comfort relief against nuisance levels of both organic vapors and acid gas
- » Contoured nose-clip provides greater comfort and helps reduce potential fogging
- » Smooth latex-free polymer head straps won't catch on hair. No pre-stretching needed
- » Latex-free, staple-free head straps for comfort and safety
- » Soft foam nose cushion
- » Collapse resistant double-shell construction, Made in USA
- » NIOSH Approved

ITEM #	ORDER #	DESCRIPTION	UOM
1735	422317355	With Organic Vapor/Acid Gas Filter Layer	20/Bx
1745	422317455	With Exhaust Valve and Organic Vapor/Acid Gas Filter Layer	10/Bx



1735



1745

GERSON®

Nuisance Dust Mask

- » For comfort relief from common household dusts only, such as grass and pollen
- » Does NOT provide lung protection
- » NOT NIOSH Approved



1501-CS

ITEM #	ORDER #	DESCRIPTION	UOM
1501-CS	422300035	Nuisance Dust Mask	50/Bx

GERSON®

OV/P95 Low Maintenance Cartridge Respirator

- » Recommended for paint spray applications, including oil-based paints
- » NIOSH OV/P95 approved for organic vapor plus solid & oil aerosols
- » Includes bonus hygiene guard & shape retainer insert
- » Completely assembled & individually packed in resealable 4-color foil bags

ITEM #	ORDER #	DESCRIPTION	UOM
8211	422300291	P95 Low Maintenance Cartridge Medium Respirator	EA
8311	422300131	P95 Low Maintenance Cartridge Large Respirator	EA



8211



Reusable



3M™ Full Facepiece Respirators, 6000 Series

- » Large lens provides a wide field of view for excellent visibility
- » Lightweight well-balanced design and silicone face seal for enhanced comfort, durability and ease of cleaning
- » Available in air-purifying and supplied air respirator modes
- » Center adapter directs exhaled breath downward
- » 3M™ Cool Flow™ Valve makes breathing easier to provide cool, dry comfort

ITEM #	ORDER #	DESCRIPTION	UOM
6800	665513621	Full Facepiece, Medium	EA
6900	665513871	Full Facepiece, Large	EA
6885	665513765	Facshield Covers	25/Bx



6800



7800S-M



3M™ Full Facepiece Respirators, 7800S Series

- » Silicone facepiece enhances fit and improves durability
- » Double-flange face seal and 6 adjustable straps help provide a secure fit
- » Can be used with a passive or electronic clip-on welding lens
- » Available in Air Purifying Respirator (APR), supplied air and Powered Air Purifying Respirator (PAPR) modes

ITEM #	ORDER #	DESCRIPTION	UOM
7800S-M	665514131	Medium	EA
7800S-L	665514121	Large	EA



3M™ Ultimate FX Full Facepiece, FF-400 Series

- » Scotchgard™ protection paint and stain resistant lens cause some liquids to bead up so they can be wiped off easily
- » Large lens provides a wide field of view for excellent visibility
- » Silicone full facepiece design offers comfort, durability and ease of cleaning
- » 3M™ Cool Flow™ Valve makes breathing easier to provide cool, dry comfort
- » Passive speaking diaphragm enhances communications

ITEM #	ORDER #	DESCRIPTION	UOM
FF-402	665520241	Medium	EA
FF-403	665520251	Large	EA



FF-402



Reusable



3M™ Half Facepiece Respirators, 6000 Series

- » This series combines comfort and convenience
- » Comfortable soft, lightweight facepiece with easy-to-adjust head straps
- » NIOSH approved for negative pressure air purifying and supplied air dual airline applications
- » Can be disassembled, cleaned and reused
- » Replaceable cartridges and filters allow reuse of facepiece for cost savings

ITEM #	ORDER #	DESCRIPTION	UOM
6100	665514821	Small	EA
6200	665501761	Medium	EA
6300	665513541	Large	EA



6100



3M™ Half Facepiece Respirators, 7500 Series

- » Advance silicone material for increased comfort and greater durability
- » Proprietary 3M™ Cool Flow™ Valve helps make breathing easier
- » Dual-mode head harness adjusts easily for either standard or drop-down mode
- » Exhalation valve cover directs exhaled breath and moisture downward to reduce fogging

ITEM #	ORDER #	DESCRIPTION	UOM
7501	665514051	Small	EA
7502	665514061	Medium	EA
7503	665514801	Large	EA



7501



3M™ Half Facepiece Respirator Assemblies, 6000 Series

- » Assembly includes Half Facepiece Respirator and Particulate Filter 2091 P100
- » Half facepiece design combines comfort and convenience
- » Remarkably comfortable, soft, lightweight facepiece and easy-to-adjust head straps
- » Removable filters can be replaced with NIOSH approved 3M™ filters and cartridges
- » NIOSH approved for environments containing certain oil and non-oil based particles

ITEM #	ORDER #	DESCRIPTION	UOM
6191	665513471	Small	EA
6291	665513521	Medium	EA
6391	665513571	Large	EA



6191



Reusable



3M™ Rugged Comfort Half Facepiece Respirators, 6500 Series

- » Resilient silicone faceseal helps provide comfort, durability, and stability with a soft but firm seal
- » Proprietary 3M™ Cool Flow™ Valve helps reduce heat and moisture
- » Exhalation valve cover helps direct exhaled breath and moisture downward to reduce fogging of eyewear and grinding and welding shields
- » Low profile half facepiece design offers a wider field of view and better compatibility with welding and grinding shields
- » Adjustable head harness assembly offers improved fit and comfort



6501



6503QL

ITEM #	ORDER #	DESCRIPTION	UOM
6501	665565271	Small	EA
6502	665565291	Medium	EA
6503	665565311	Large	EA
6501QL	665565281	With Quick Latch, Small	EA
6502QL	665565301	With Quick Latch, Medium	EA
6503QL	665565321	With Quick Latch, Large	EA



3M™ Rugged Comfort 6500 Accessories

- » Accessories for 3M™ Rugged Comfort Half Facepiece 6500 Series Respirators

ITEM #	ORDER #	DESCRIPTION	UOM
6581	665565335	Head Harness Assembly	5/Bx
6582	665565345	Head Harness Assembly with Quick Latch	5/Bx
6583	66556535	Exhalation Valve, System Component	10/Cs



3M™ Mold Remediation Respirator Kit

- » Includes a 3M™ Full Facepiece 6000 and two pairs of nuisance organic vapor 3M™ Particulate Filters 2097, P100
- » Large lens for wide field of view
- » Lightweight, balanced design
- » Silicone faceseal for greater comfort and durability

ITEM #	ORDER #	DESCRIPTION	UOM
68097	665513661	Medium	EA



68097



Reusable

3M™ 3M™ Replacement Cartridges and Filters

All 3M Particulate Filters and Gas/Vapor Cartridges can be used interchangeably with 3M™ Reusable Respirators 6000, 6500, 7000, and FF-400 Series.

3M™ Particulate Filters 2000 Series

- » Lightweight and easy to breathe through
- » Assortment of filters available for a wide range of applications
- » Easier breathing through new 3-layer advanced Electret Filter Media in 2200 Series Filters

3M™ Particulate Filters 7093, P100

- » Unique, spring-loaded filter cover design simplifies negative pressure user seal checks
- » Swept-back design provides enhanced field of view and greater comfort

3M™ Gas/Vapor Cartridges 6000 Series

- » Low-profile design helps maintain good field of vision
- » Full range of cartridges to meet your needs

3M™ Combination Cartridges/P100 Particulate Filters 6000 Series

- » Particulate filter is permanently attached to cartridge for easy, one-step assembly
- » Unique design for enhanced comfort and visibility



ITEM #	ORDER #	DESCRIPTION	UOM
6894	665513811	Full Face Nose Cup Assembly	EA
6897	665513841	Full Face Head Harness Assembly	EA
6001	665513305	Organic Vapor Cartridge	2/Bx
6002	665510021	Acid Gas Cartridge	2/Bx
6003	665501145	Organic Vapor/Acid Gas Cartridge	2/Bx
6004	665513315	Ammonia/Methylamine Cartridge	2/Bx
6005	665514795	Formaldehyde***/Organic Vapor Cartridge	2/Bx
6006	665513325	Multi-Gas/Vapor Cartridge	2/Bx
60921	665513355	Cartridge/Filter Organic Vapor/P100	2/Bx
60922	665513365	Cartridge/Filter Acid Gas/P100	2/Bx
60923	665513375	Cartridge/Filter Formaldehyde***/Organic/Vapor/P100	2/Bx
60924	665513385	Cartridge/Filter Ammonia/Methylamine/P100	2/Bx
60925	665513395	Cartridge/Filter Formaldehyde***/Organic Vapor/P100	2/Bx
60926	665513405	Cartridge/Filter Multi-Gas/ Vapor/P100	2/Bx
2071	665511655	Particulate Filter P95	2/Bx
2091	665520915	Particulate Filter P100	2/Bx
2096	665511685	Particulate Filter P100 w/Nuisance Level Acid Gas* Relief	2/Bx
2097	665511695	Particulate Filter P100 w/Nuisance Level Organic Vapor* Relief & Ozone Protection**	2/Bx
2291	665522915	Advanced Particulate Filter P100	2/Bx
7093	665513935	Particulate Filter P100, Solid Top Air Inlet	12/Bx
501	665512085	Filter Retainer	20/Bx
5N11	665512065	Particulate Pre-Filter N95	10/Bx
5P71	665512075	Particulate Pre-Filter P95	10/Bx
504	665512105	Respirator Cleaning Wipes	100/Bx
2078	665511675	Particulate Filter, P95 w/Nuisance Level Organic Vapor*/Acid Gas* Relief & Ozone Protection**	2/Bx
6009S	665513335	Mercury Vapor/Chlorine or Sulfur Dioxide Gas Cartridge	2/Bx
60929S	665513425	Mercury Vapor/Chlorine or Sulfur Dioxide Gas/P100 Particulate Filter Combination Cartridge	2/Bx
60921i	665532845	Cartridge/Filter Organic Vapor/P100	2/Bx
6001i	66553171	Organic Vapor Cartridge, Vend Pack	60/Cs

*Nuisance level refers to concentrations not exceeding OSHA PEL or other applicable government occupational exposure limits, whichever is lower. Full facepieces must be quantitatively fit tested to claim assigned protection factor above 10 in negative pressure mode. Do not use in for respiratory protection against organic vapors or acid gases or environments that are immediately dangerous to life or health (IDLH). Not NIOSH certified for use against ozone.

**The filter is effective for concentrations up to 10 times the Permissible Exposure Limit (PEL) with half facepieces, or 50 times PEL with quantitatively fit tested full facepieces. This filter helps protect against a wide range of oil and non-oil based particulate contaminants. The filter also offers nuisance level odor relief from organic vapors that are below the PEL. Nuisance level refers to concentrations not exceeding OSHA PEL or other applicable government exposure limits, whichever is lower. Do not use for respiratory protection against organic vapors or in environments that are immediately dangerous to life or health (IDLH).

***OSHA requires that gas-proof goggles be worn with half facepiece respirators when used against formaldehyde.

RESPIRATORY



Reusable



H-410-10

3M 3M™ Hood H-410-10 with Collar

- » H-Series hoods provide head and neck protection from pesticide and chemical overspray
- » Lightweight, loose fitting, for use with belt-mounted PAPRs or supplied air components
- » This hood is a replacement for 3M™ Hood Assemblies H-411 and H-412
- » NIOSH Approved

ITEM #	ORDER #	DESCRIPTION	UOM
H-410-10	66550711	Tychem® QC Hood with Collar	10/Cs



BE-10-3

3M 3M™ Respirator Hoods

- » Lightweight, comfortable respirator hood helps provide respiratory protection for a wide range of applications
- » Used with 3M™ Air-Mate™ and Breathe Easy™ Powered Air Purifying Respirators (PAPR) and 3M™ Supplied Air Hood Systems BE-Series
- » Double bib hood
- » NIOSH Approved
- » US OSHA APF of 1000

ITEM #	ORDER #	DESCRIPTION	UOM
BE-10-3	665506335	Tyvek® QC Hood	3/Pk

MOLDEX

7000 Series Reusable Half Mask Respirators

- » Compact, fits under welding helmets
- » Adjustable head harness for a custom fit
- » Low profile, angled cartridge placement for wider field of vision
- » Contoured neck buckles for comfort and quick attachment
- » Attached exhale cover for easy inspection
- » Easy mount bayonet cartridge/filter attachment
- » Wide flange fits more facial shapes comfortably

ITEM #	ORDER #	DESCRIPTION	UOM
7001	222270011	Small	EA
7002	222270021	Medium	EA
7003	222270031	Large	EA



7002



Reusable



7800 Series Premium Silicone Half Mask Respirators

- » Premium silicone half mask has higher resistance to heat and compression
- » Compact, fits under welding helmets
- » Adjustable head harness for a custom fit
- » Low profile, angled cartridge placement for wider field of vision
- » Contoured neck buckles for comfort and quick attachment
- » Attached exhale cover for easy inspection
- » Easy mount bayonet cartridge/filter attachment
- » Wide flange fits more facial shapes comfortably

ITEM #	ORDER #	DESCRIPTION	UOM
7801	222200111	Small	EA
7802	222200131	Medium	EA
7803	222200141	Large	EA



7802



9000 Series Reusable Full-Face Respirators

- » Lightest weight facepiece of any popular model. Weighs less than 13 oz.
- » Lens with scratch resistant coating meets ANSI Z87+ for impact protection. Tear away lens protector included
- » Panoramic lens with peripheral vision side panels
- » Over-molded flange to lens. Eliminates heavy metal clamping frame for less weight and fewer parts
- » Completely free of metal parts
- » Stand away head harness for easy donning
- » Over-molded buckles for secure strap attachment. One finger strap release
- » Integrated exhale area with attached cover. Fewer parts, simple maintenance and inspection
- » Easy mount bayonet cartridge/filter attachment



9002

ITEM #	ORDER #	DESCRIPTION	UOM
9002	222290021	Medium	EA
9003	222290031	Large	EA



7000/9000 Series Combo Stacked Cartridge/Filters

- » Pre-assembled Cartridge + Adapter + Filter for easy attachment
- » Optional replacement of either cartridge or filter, as needed, for optimum usage and cost savings

ITEM #	ORDER #	DESCRIPTION	UOM
7140	222271401	Organic Vapor Cartridge/P100	PR
7640	222276401	Multi-Gas/Vapor Smart® Cartridge/P100	PR



7140



7640



Reusable



7000/7800/9000 Series Cartridges and Filters

» Cartridges and filters for 7000/7800/9000 Series masks and respirators



7020



7100



7600



7200



7300



7500



7400

ITEM #	ORDER #	DESCRIPTION	UOM
7020	222270201	Prefilter Retainer	PR
7100	222271001	Organic Vapor Cartridge	PR
7200	222272001	Acid Gas Cartridge	PR
7300	222273001	Organic Vapor/Acid Gas Cartridge	PR
7400	222274001	Ammonia/Methylamine Cartridge	PR
7500	222275001	Formaldehyde Cartridge	PR
7600	222276001	Multi-Gas/Vapor Smart® Cartridge	PR
7920	222279201	Piggyback Adapter	PR
7940	222279401	P100 Filter Disk	PR
7950	222279501	P100 Filter Disk Plus Nuisance Organic Vapors/Acid Gas	PR
7960	222279601	P100 w/Nuisance OV Filter Disk	PR
7990	222279901	P100 Particulates Cartridge	PR
7999	222279991	P100 Filter Disk Cover	PR
8910	222243425	N95 Prefilters	5 Pr/Bg
8970	222289705	R95 Prefilters	5 Pr/Bg



7920



7940



7990



54001



5400 Series Low-Maintenance Full Facepiece Respirator

- » Dual Cartridge Elastomeric Full Facepiece with four strap headband
- » Standard features include a nose cup and wide 200° field of vision
- » The 5400 easily converts to a PAPR or Supplied Air respirator
- » Available with welding adapter
- » Latex-free

ITEM #	ORDER #	DESCRIPTION	UOM
54001	347640011	Medium/Large	EA
54001S	347640001	Small	EA



7600 Series Full Facepiece Respirator

- » 100% Silicon premium elastomeric full facepiece w/5 point headstrap
- » Can also be used with PAPR or supplied air respirators to fit different using environments
- » With specially designed oral/nasal cup to lessen - dead space
- » Dual facial seal design to offer better seal on the face and satisfy various demands of different facial types
- » Center-fixing harness on the head enhances the stability which can provide perfect seal
- » Provides a 200° field of vision
- » Polycarbonate lens meets ANSI standard for high impact

ITEM #	ORDER #	DESCRIPTION	UOM
760008A	347637481	Medium/Large	EA



760008A



Reusable

Honeywell NORTH

7600 Series Voice Amplifier for Full Facepieces

- » Voice Amplifier assembly for 7600 Series full facepieces
- » Complete with amplifier and adapter ring
- » Uses two AAA alkaline batteries (not included)

ITEM #	ORDER #	DESCRIPTION	UOM
7600VA	347689441	Voice Amplifier	EA



7600VA

Honeywell NORTH

RU6500 Full Facepiece

- » Silicone seal provides excellent facepiece seal
- » Silicone nose cup is soft and comfortable for all day wear
- » Polycarbonate lens with wide field of vision maximized peripheral visions plus downward view; meets ANSI Z 87 for high impact
- » 5-point strap option includes center strap to help position and hold the mask for a more secure fit; offers quick, easy adjustments
- » Can be adapted to CF-SAR, belt mount PAPR and mask mount PAPR eliminating the need to fit test workers on several respirators



RU65001S

ITEM #	ORDER #	DESCRIPTION	UOM
RU65001S	341569101	Small	EA
RU65001M	341569111	Medium	EA
RU65001L	341569121	Large	EA

Honeywell NORTH

5500 Series Half Mask Respirators

- » 5500 Series Elastomeric half mask is the economical option that still provides many of the same features found in premium masks
- » Upper headstraps have minimum give to provide secure support
- » Lower headstraps stretch and move with the worker for more comfort without pulling on the facepiece
- » Converts to PAPR or supplied air respirator
- » Latex-free
- » NIOSH Certified

ITEM #	ORDER #	DESCRIPTION	UOM
550030M	347657231	Medium	EA
550030L	347657241	Large	EA



550030M



Reusable

Honeywell**NORTH**

7700 Series Silicone Half Mask Respirators

- » Made from 100% medical grade silicone, the wide sealing area provides exceptional fit and comfort
- » Cradle suspension features woven straps that provide for maximum mobility without sacrificing support
- » Upper headstraps have minimum give to provide secure support
- » Lower headstraps stretch and move with the worker for more comfort without pulling on the facepiece
- » Converts to PAPR or supplied air respirator
- » Latex-free
- » NIOSH Certified

ITEM #	ORDER #	DESCRIPTION	UOM
770030M	347657201	Medium	EA
770030L	347657211	Large	EA



770030M

Honeywell**NORTH**

7900 Series Escape Mouthbit Respirator

- » 7900 Series mouthbit respirators offer a quick and economical method to escape non-IDLH emergency situations
- » Soft and flexible mouthpiece uses same design used for snorkeling equipment, improves grip and comfort
- » Wide nose clip fits most facial types
- » Belt clip for fast and easy access
- » NIOSH Certified

ITEM #	ORDER #	DESCRIPTION	UOM
7902	347638021	Mouthbit Respirator	EA



7902

Honeywell**NORTH**

N-Series Cartridges, Filters and Cartridges/Filter Combinations

- » Cartridges for use with 5500, RU8500 and 7700 Series half masks as well as 5400, RU6500 and 7600 Series full facepieces - NIOSH certified

ITEM #	ORDER #	DESCRIPTION	UOM
75SCL	347657411	Defender Multi-Contaminant Cartridge	PR
75SCP100L	347637001	Defender Multi-Contaminant Cartridge & P100 Filter Combination	PR
N75001L	347650011	Organic Vapor Cartridge	PR
7582P100L	347601001	Acid Gas Cartridge & P100 Filter Combination	PR
N75003L	347657485	Organic Vapor & Acid Gas Cartridge	PR
7583P100L	347631001	Organic Vapor & Acid Gas Cartridge & P100 Filter Combination	PR
N75004L	347675001	Ammonia & Methelamine Cartridge	PR
7584P100L	347637461	Ammonia & Methelamine Cartridge & P100 Filter Combination	PR
7580P100	347637441	Filter, P100 For All Particulates	PR
75FFP100	347651001	Filter, P100	PR
7506N95	347637025	Filter, N95	10/Pk
7506N99	347637035	Filter, N99	10/Pk
7506R95	347637045	Filter, R95	10/Pk
N750036	347600361	Filter Retainer	PR



75SCL



75SCP100L



7580P100



75FFP100



7506N95



N750036



Reusable



815452



Advantage® 200 LS Respirators

- » Advantage® 200 LS respirators offer economy, unmatched fit, and comfort with a soft blue facepiece
- » Thermoplastic rubber subtracts a quarter of the weight and adds softness
- » Patented MultiFlex® System equalizes face seal area pressure while delivering exceptional stability
- » AnthroCurve™ Sealing Surface instantly conforms to each wearer's unique facial characteristics
- » NIOSH approved

ITEM #	ORDER #	DESCRIPTION	UOM
815444	308599131	Medium	EA
815452	308599151	Large	EA



Advantage® 420 Series Half-Mask Respirator

- » Advantage® 420 half-mask respirator incorporates maximum comfort, improved donning and fit, enhanced safety and reduced maintenance cost
- » Patent-pending UniBond silicone facepiece helps to eliminate possible leak paths
- » Drop-down harness position allows respirator removal while retaining head protection
- » AnthroCurve™ II Sealing Surface instantly conforms to each wearer's unique facial characteristics
- » Latex-free

ITEM #	ORDER #	DESCRIPTION	UOM
10102183	3085143D1	Medium	EA



10102183



Advantage® 3200 Full Facepiece Respirators

- » Advantage® 3200 twin-port respirators are designed for comfort and versatility; users can position upper straps for consistent fit and minimal adjustment
- » Pre-set upper straps prevent snags during donning and doffing, providing a tighter, more secure seal
- » Wraparound scratch-resistant polycarbonate facepiece lens provides wide distortion-free field of vision
- » Lens meets all ANSI Z87.1+ requirements including high-impact performance requirements
- » Approved with all MSA Advantage cartridges

ITEM #	ORDER #	DESCRIPTION	UOM
10028995	308524661	Medium	EA
10028997	308524681	Large	EA



10028995



Reusable



Advantage® 4000 Full Facepiece Respirators

- » Advantage® 4200 twin-port facepiece is a dedicated twin-cartridge respirator
- » Unique in-turned lip provides the best possible face seal contours
- » Facepieces are in Hycar rubber
- » Net head harnesses enable a perfect fit
- » Nosecup is standard for reduced fogging in low-temperature or high-moisture environments



10083789

ITEM #	ORDER #	DESCRIPTION	UOM
10083781	3085901D1	Medium	EA
10083789	3085370E1	Large	EA



815355



815362



815359



815369



Advantage® Respirator Cartridges

- » The Advantage® line of particulate, chemical and combination cartridges is NIOSH-certified to 42 CFR, Part 84 and provides lightweight, low-profile performance
- » Cartridges fit 200 LS and 420 half-masks, 1000, 3000 and 4000 series full-facepiece Advantage respirators

ITEM #	ORDER #	DESCRIPTION	UOM
815355	308598981	Organic Vapor (GMA) Cartridge	2/Pk
815362	308599031	Organic Vapor/P100 (GMA) Cartridge	2/Pk
815359	308553591	Multigas (GME) Cartridge	2/Pk
815369	308599075	Low-Profile P100 Cartridge	2/Pk



818342



818343



818344



Flexi-Filter Pads for Advantage® Respirators

- » Low-profile, flexible pads fit well under a welding hood and with other personal protective equipment
- » They offer great balance and weight distribution for maintaining a good face seal
- » Their swept-back design provides improved vision and comfort

ITEM #	ORDER #	DESCRIPTION	UOM
818342	308583425	Flexi-Filter/P100	2/Pk
818343	3085163A5	Flexi-Filter/P100 w/Nuisance Level OV, Ozone Removal	2/Pk
818344	3085164A5	Flexi-Filter/P100 w/Nuisance Level AG, HF Removal	2/Pk



PAPR (Powered Air Purifying Respirators)



3M™ Versaflo™ TR-600 PAPR Kits

» Versaflo™ TR-660 are complete (PAPR) Powered Air Purifying Respirator systems and includes everything required to get started for use in operations where it is important to be able to easily clean the PAPR system

TR-600-ECK kit includes:

S-433L Hood with Integrated Head Suspension, BT-30 Length Adjusting Breathing Tube, TR-6710N (HE) Filter, TR-641N Single Station Battery Charger, BT-922 Breathing Tube Cover, TR-602N PAPR Unit, TR-630 Standard Battery, TR-627 Easy Clean Belt, TR-6700 Filter Cover, TR-6600 Prefilter (X2), TR-662 Spark Arrestor (X2), TR-971 Airflow Indicator.

The TR-600-HIK kit includes:

M-307 Respiratory Hard Hat Assembly with Premium Visor and Faceseal, TR-602N PAPR Unit, TR-632 High Capacity Battery, BT-30 Length Adjusting Breathing Tube, TR-626 High Durability Belt, TR-6530N OV/AG/HE Cartridge, TR-6500 Filter Cover, TR-641N Single Station Battery Charger Kit, TR-971 Airflow Indicator, BT-926 High Temperature Breathing Tube Cover, TR-6600 Prefilter (x2), TR-662 Spark Arrestor (x2).

ITEM #	ORDER #	DESCRIPTION	UOM
TR-600-ECK	665529961	Easy Clean Kit	EA
TR-600-HIK	66553057	Heavy Industrial Kit	EA
TR-6600	66553005	Prefilter for TR-600 Kits	5/Cs



3M™ Versaflo™ Premium Holder for V-100 & V-200 Series Air Regulating Valves

- » Enables V-100 and V-200 air regulating valves to be worn in a vertical or horizontal position for comfort of wear
- » Enables use of TR-325 standard belt, TR-326 high durability belt or TR-327 easy clean belt
- » Provides thermal padding between valve and wearer
- » Securely holds valve during use

ITEM #	ORDER #	DESCRIPTION	UOM
V-112	665541551	Holder for Air Regulating Valves	EA



V-112



3M™ Versaflo™ HEPA and Nuisance OV Filter

- » For use on TR-600 series PAPRs
- » Removes certain nuisance odors for comfort
- » High efficiency filter
- » Lighter and smaller than a full-size cartridge
- » NIOSH approval: HF/HE



TR-6820N

ITEM #	ORDER #	DESCRIPTION	UOM
TR-6820N	66553841	HEPA and Nuisance OV Filter	5/Cs



PAPR (Powered Air Purifying Respirators)



3M™ Versaflo™/Breathe Easy™ PAPR Accessories

» Accessory items for Veraflo™ and Breathe Easy™ PAPRs



BT-40

ITEM #	ORDER #	DESCRIPTION	UOM
BT-30	665530301	Versaflo™ Length Adjusting Breathing Tube	EA
BT-40	665525721	Versaflo™ Heavy Duty Neoprene Rubber Breathing Tube	EA



3M™ Versaflo™ Respiratory Helmet Assembly

» When used with an approved air source, M-400 Series helmets provide respiratory (OSHA APF=1000) and limited head (ANSI Z89.1-2003 Type 1 Class G) and eye (ANSI Z87.1-2010) protection



M-407

ITEM #	ORDER #	DESCRIPTION	UOM
M-407	665584071	With Premium Visor and Flame Resistant Shroud	EA
M-405	665525421	With Standard Visor and Shroud	EA



S-403L-20



S-433L-5



S-607-10



3M™ Versaflo™ Respiratory Helmet Assembly

» When used with an approved air source, M-400 Series helmets provide respiratory (OSHA APF=1000) and limited head (ANSI Z89.1-2003 Type 1 Class G) and eye (ANSI Z87.1-2010) protection

ITEM #	ORDER #	DESCRIPTION	UOM
S-403L-20	66553320	Economy Hood, Medium/Large	20/Cs
S-433L-5	66554532	Hood with Integrated Head Suspension, Medium/Large	5/Cs
S-607-10	66552378	Hood with Inner Shroud for Premium Head Suspension	10/Cs
S-707-10	66552385	Painter's Hood with Inner Shroud for Premium Head Suspension	10/Cs



PAPR (Powered Air Purifying Respirators)



EZ Air Powered Air Purifying Respirator (PAPR)

- » Complete particulate system intended for industrial applications where combined respiratory, eye and face protection is required
- » Motorized, Lithium-ion battery operated system that provides a constant supply of fresh, filtered air, at an APF level of 25
- » Recommended applications are welding, assembly, facility maintenance, grinding, machine operations, painting and sanding
- » Complies with ANSI Z87.1+ for face-shield/eye protection
- » NIOSH approved complete PAPR assembly includes welding shield w/ADF lens, downtube w/FR cover, blower, battery, waist belt, charger, flow tester, HEPA filter and storage bag

ITEM #	ORDER #	DESCRIPTION	UOM
9935-DLX	334205821	EZ Air PAPR	EA
9935-FIL	334205831	Replacement HEPA Filter	EA



Accessories



Bitrex™, Saccharin and Smoke Fit Test Kits

- » Allegro offers qualitative OSHA-compliant fit testing for disposable and reusable dust and mist respirators
- » Bitrex™ Fit Test Kit creates an unmistakable bitter taste that indicates breakthrough in the respirator fit
- » Saccharin Fit Test Kit creates the sweet taste of saccharin when the respirator has failed its fit test
- » Smoke Fit Test Kit offers everything needed for meeting OSHA's protocol for fit testing with smoke

ITEM #	ORDER #	DESCRIPTION	UOM
2041	334200611	Bitrex Fit Test Kit	EA
2041-11K	334200625	Bitrex Sensitivity Solution Only	6/Bx
2041-12K	334200635	Bitrex Test Solution Only	6/Bx
2040	334200571	Saccharin Test Kit	EA
2040-11K	334200595	Saccharin Sensitivity Solution Only	6/Bx
2040-12K	334200605	Saccharin Test Solution Only	6/Bx
2050	334200641	Standard Smoke Test Kit	EA
2050-01	334200651	Smoke Test Replacement Tubes	6/Bx



WARNING: Cancer and Reproductive Harm - www.P65Warnings.ca.gov



Accessories



Respirator Storage Bags

- » Storage bags keep respirator and personal safety equipment contaminant free
- » Disposable large respirator storage bags come with pressure-sensitive seals where cleaning information can be recorded
- » Full mask storage bag is made with cotton outer fabric and fleece inside to protect mask with a drawstring closure
- » Reusable respirator storage bags are made of tough 10 mil poly to last longer and hold half-or full mask sizes



4001-05



2025



2000

ITEM #	ORDER #	DESCRIPTION	UOM
4001-05	33420105	Large Disposable Respirator Bags, 11"W x 8"D x 21"H	100/Pk
2025	334220251	Full Mask Storage Bag	EA
2000	33422000	Respirator Storage Bag	EA

WARNING: Cancer and Reproductive Harm - www.P65Warnings.ca.gov



1001

3001



Respirator Cleaning Pads

- » The boxes are designed as a wall mount, 100/box
- » Large 5" x 8" individually foil-packaged towelettes
- » Respirator Cleaning Pads contain 70% Isopropanol and are designed specifically for rubber respirator facepieces
- » Alcohol Free Cleaning Pads designed for use on respirator facepieces and other personal safety equipment requiring a non-alcohol cleaning wipe. Active ingredient: Benzalkonium Chloride. Will not harm even the most sensitive rubber facepiece

ITEM #	ORDER #	DESCRIPTION	UOM
1001	334210015	Respirator Cleaning Pads	100/Bx
3001	334230015	Alcohol Free Cleaning Pads	100/Bx



Spray Socks

- » Provides comfortable protection against overspray and other particulates
- » Spray Sock fits over the head and can be worn with goggles, half mask or full mask respirators
- » The stretch knit material is breathable and cool to wear, one size fits most

ITEM #	ORDER #	DESCRIPTION	UOM
1410-12	334200465	Spray Socks	12/Pk



1410-12



Needlestick Resistant

HexArmor

HexArmor® 9014 SharpsMaster II® Gloves

- » Highest needlestick resistance available provided by the layering of SuperFabric® brand material in the palm
- » Tested using actual 25 gauge needles against ANSI/ISEA 105 standard
- » ANSI/ISEA Cut Level A9 and Needlestick Level 5
- » Single-glove needle solution with incredible dexterity and comfort
- » Comfortable cotton blend shell with wrinkle rubber palm coating for exceptional dexterity and feel



9014



3 Layer SuperFabric®

ITEM #	ORDER #	SIZE	UOM
9014-S	E28801041	7/Small	PR
9014-M	E28801481	8/Medium	PR
9014-L	E28801491	9/Large	PR
9014-XL	E28814101	10/X-Large	PR

Puncture-Resistant

HexArmor



9011

HexArmor® 9000 Series™ 9011 Gloves

- » SuperFabric® brand material with cut protection
- » Wrinkle rubber latex palm coating
- » Innovative industrial puncture protection on enhanced areas from wires, metal, wood, and glass
- » Comfortable cotton blend shell with wrinkle rubber palm coating for exceptional dexterity and feel
- » ANSI/ISEA 5 puncture resistance
- » ANSI/ISEA level A7 cut resistance

ITEM #	ORDER #	SIZE	UOM
9011-S	E28801721	7/Small	PR
9011-M	E28801551	8/Medium	PR
9011-L	E28801561	9/Large	PR
9011-XL	E28801731	10/X-Large	PR

HexArmor



9010

HexArmor® 9000 Series™ 9010 Gloves

- » SuperFabric® brand material palm provides some of the highest cut-resistance available in the industry
- » Shell is comprised of a high-performance polyethylene fiber and glass fiber blend
- » Black flat nitrile palm dip increases snag and abrasion resistance and provides exceptional grip for dry and light oil situations
- » ANSI/ISEA 5 puncture resistance
- » ANSI/ISEA level A8 cut resistance

ITEM #	ORDER #	SIZE	UOM
9010-M	E28891081	8/Medium	PR
9010-L	E28891091	9/Large	PR
9010-XL	E28891101	10/X-Large	PR



Cut-Resistant



HexArmor

2021

HexArmor® 2021 Rig Lizard® Gloves

- » Durable TP-X® palm with reinforced stitching pattern
- » Back-of-hand IR-X® Impact Exoskeleton™ with high-flex design
- » Reinforced index finger and thumb crotch
- » SlipFit® cuff adds comfort and convenience
- » ANSI/ISEA cut level A3 resistance
- » ANSI/ISEA 138 Level 1 impact protection
- » Lab tested in accordance with EN407 contact heat for a level 2 performance

ITEM #	ORDER #	SIZE	UOM
2021-M	E28801161	8/Medium	PR
2021-L	E28801171	9/Large	PR
2021-XL	E28801181	10/X-Large	PR
2021-2X	E28801191	11/2X-Large	PR



HexArmor

2090X

HexArmor® 2090X Rig Lizard® Thin Lizzie™ Gloves

- » High-performance polyethylene and glass fiber blend shell
- » Flexible sandy nitrile palm coating
- » Back-of-hand IR-X® Impact Exoskeleton™ with high-flex design
- » Reinforced thumb crotch patch
- » Knit wrist helps prevent dirt and debris from entering the glove
- » ANSI/ISEA 138 Level 1 impact protection
- » ANSI/ISEA cut level A4 protection

ITEM #	ORDER #	SIZE	UOM
2090X-S	E28800921	7/Small	PR
2090X-M	E28800931	8/Medium	PR
2090X-L	E28800941	9/Large	PR
2090X-XL	E28800951	10/X-Large	PR



HexArmor

2092

HexArmor® 2092 Rig Lizard® Thin Lizzie™ Gloves

- » High-performance polyethylene/glass fiber blend shell
- » Flexible sandy nitrile palm coating
- » Back-of-hand IR-X® Impact Exoskeleton™ with high-flex design
- » Reinforced thumb crotch patch
- » Padded palm for vibration reduction
- » Elastic cuff with Velcro® closure
- » ANSI/ISEA 138 Level 1 impact protection
- » ANSI/ISEA cut level A4 protection

ITEM #	ORDER #	SIZE	UOM
2092-S	E28800851	7/Small	PR
2092-M	E28800841	8/Medium	PR
2092-L	E28800831	9/Large	PR
2092-XL	E28800821	10/X-Large	PR
2092-2X	E28800811	11/2X-Large	PR



HexArmor

2095

HexArmor® 2095 Rig Lizard® Thin Lizzie™ Gloves

- » 13-gauge HPPE, steel, and fiberglass blend shell
- » Polyurethane palm coating provides superior grip and abrasion resistance
- » Back-of-hand IR-X® Impact Exoskeleton™ with high-flex design
- » Touchscreen capabilities
- » ANSI/ISEA 138 Level 1 impact protection
- » ANSI/ISEA cut level A5 protection

ITEM #	ORDER #	SIZE	UOM
2095-S	E28801301	7/Small	PR
2095-M	E28801331	8/Medium	PR
2095-L	E28801361	9/Large	PR
2095-XL	E28801371	10/X-Large	PR
2095-2X	E28801381	11/2X-Large	PR



Cut-Resistant



HexArmor

4060

HexArmor® 4060 Chrome SLT® Gloves

- » Goatskin leather palm
- » SlipFit® cuff assists a quick on and off
- » Back-of-hand impact protection
- » 360 degree A5 cut protection
- » ANSI/ISEA 138 Level 1 protection
- » EN407:2004 certified for Contact Heat Level 2, and large splashes of molten metal Level 1
- » Lab tested in accordance with HRC ATPV: 23.6 Cal/cm2 for a level 2 performance

ITEM #	ORDER #	SIZE	UOM
4060-M	E28801391	8/Medium	PR
4060-L	E28801421	9/Large	PR
4060-XL	E28801441	10/X-Large	PR
4060-2X	E28801341	11/2X-Large	PR



HexArmor

4080

HexArmor® 4080 Chrome Series® Gloves

- » Goatskin leather provides a traditional style of comfort and grip
- » SuperFabric® brand material palm provides the highest cut-resistance available (interior layer)
- » Hi-vis back-of-hand impact protection system
- » Velcro® cuff for a comfortable and precise fit
- » ANSI/ISEA level A8 cut resistance
- » ANSI/ISEA 138 Level 1 impact protection
- » EN407 level 2 contact heat rated

ITEM #	ORDER #	SIZE	UOM
4080-M	E28801511	8/Medium	PR
4080-L	E28801521	9/Large	PR
4080-XL	E28801541	10/X-Large	PR



HexArmor

4061

HexArmor® 4061 Chrome SLT® Gloves

- » Goatskin leather palm
- » SlipFit® cuff assists a quick on and off
- » 360 degree A5 cut protection
- » EN407:2004 certified for Burning Behavior Level 4, Contact Heat Level 2, Convective Heat Level 2, Radiant Heat Level 2, Small splashes of molten metal Level 4, and large splashes of molten metal Level 1
- » Lab tested in accordance with HRC ATPV: 46 Cal/cm2 for a level 4 performance

ITEM #	ORDER #	SIZE	UOM
4061-M	E28801461	8/Medium	PR
4061-L	E28801471	9/Large	PR
4061-XL	E28801501	10/X-Large	PR
4061-2X	E28801351	11/2X-Large	PR



HexArmor

4026

HexArmor® 4026 Chrome Series® Gloves

- » SuperFabric® brand material palm provides highest cut-resistance available in the industry
- » Superior back-of-hand impact protection system
- » HexArmor Mud Grip® palm provides reliable grip in dry or light oil situations
- » Hi-vis color scheme increases visual awareness
- » EN407 level 1 contact heat rated
- » ANSI/ISEA level A8 cut resistance
- » ANSI/ISEA 138 Level 1 impact protection

ITEM #	ORDER #	SIZE	UOM
4026-S	E28800191	7/Small	PR
4026-M	E28800201	8/Medium	PR
4026-L	E28800211	9/Large	PR
4026-XL	E28800221	10/X-Large	PR
4026-2X	E28800231	11/2X-Large	PR



Cut-Resistant



HexArmor

4070

HexArmor® 4070 Chrome SLT® Gloves

- » Back-of-hand impact protection
- » HPPE blend liner gives 360° cut protection
- » Synthetic leather palm with abrasion-resistant PVC dots provides a durable grip in dry or light oil situations
- » Elastic cuff with Velcro® closure
- » ANSI/ISEA 138 Level 1 impact protection
- » ANSI/ISEA Level A6 cut protection

ITEM #	ORDER #	SIZE	UOM
4070-S	E28801261	7/Small	PR
4070-M	E28801221	8/Medium	PR
4070-L	E28801241	9/Large	PR
4070-XL	E28801201	10/X-Large	PR



HexArmor

4072

HexArmor® 4072 Chrome SLT® Gloves

- » HPPE blend liner gives 360° cut protection
- » Synthetic leather palm provides a superior wet/dry grip and abrasion resistance
- » SlipFit® cuff for a quick on and off between tasks
- » High dexterity, hi-vis materials
- » ANSI/ISEA Level A6 cut protection

ITEM #	ORDER #	SIZE	UOM
4072-S	E28801281	7/Small	PR
4072-M	E28801291	8/Medium	PR
4072-L	E28801311	9/Large	PR
4072-XL	E28801321	10/X-Large	PR

HexArmor

HexArmor® Helix® Gloves

- » 13-gauge HPPE and fiberglass blend shell offering 360° degree cut protection
- » Knit wrist helps prevent dirt and debris from entering the glove
- » Silicone-free



2085



2088

2076

ITEM #	ORDER #	SIZE	DESCRIPTION	UOM
2085-S	E28801211	7/Small	Grey polyurethane palm coating, ANSI/ISEA A4 cut protection	PR
2085-M	E28801231	8/Medium	Grey polyurethane palm coating, ANSI/ISEA A4 cut protection	PR
2085-L	E28801251	9/Large	Grey polyurethane palm coating, ANSI/ISEA A4 cut protection	PR
2085-XL	E28801271	10/X-Large	Grey polyurethane palm coating, ANSI/ISEA A4 cut protection	PR
2088-S	E28801071	7/Small	Black foam nitrile three-quarter palm and finger coating, ANSI/ISEA A4 cut protection	PR
2088-M	E28800631	8/Medium	Black foam nitrile three-quarter palm and finger coating, ANSI/ISEA A4 cut protection	PR
2088-L	E28800641	9/Large	Black foam nitrile three-quarter palm and finger coating, ANSI/ISEA A4 cut protection	PR
2088-XL	E28800621	10/X-Large	Black foam nitrile three-quarter palm and finger coating, ANSI/ISEA A4 cut protection	PR
2076-S	E28800461	7/Small	Black polyurethane palm coating, ANSI/ISEA A5 cut protection, Touchscreen capabilities	PR
2076-M	E28800471	8/Medium	Black polyurethane palm coating, ANSI/ISEA A5 cut protection, Touchscreen capabilities	PR
2076-L	E28800481	9/Large	Black polyurethane palm coating, ANSI/ISEA A5 cut protection, Touchscreen capabilities	PR
2076-XL	E28800491	10/X-Large	Black polyurethane palm coating, ANSI/ISEA A5 cut protection, Touchscreen capabilities	PR
2076-2X	E28800551	11/2X-Large	Black polyurethane palm coating, ANSI/ISEA A5 cut protection, Touchscreen capabilities	PR



Cut-Resistant



11-627

Ansell

HyFlex® 11-627 Light Duty Gloves

- » Dyneema® and Lycra® liner gives cool, comfortable feeling and helps reduce hand fatigue
- » Polyurethane coating and liner combination improves tactile sensitivity with grip and control
- » ANSI Abrasion Level 6, ANSI Cut Level 2
- » Launderable, durable materials

ITEM #	ORDER #	DESCRIPTION	UOM
11-627-6	220101171	Size 6	PR
11-627-7	220101191	Size 7	PR
11-627-8	220101201	Size 8	PR
11-627-9	220101211	Size 9	PR
11-627-10	220101051	Size 10	PR

⚠ WARNING: Cancer and Reproductive Harm - www.P65Warnings.ca.gov



11-624

Ansell

HyFlex® 11-624 Medium Duty Gloves

- » Unmatched combination of comfort, softness, coolness & cut protection
- » Polyurethane coating provides sure grip in light oil and dry properties
- » Product curves naturally to prevent hand fatigue
- » ANSI Cut Level 2, ISO Cut Level B

ITEM #	ORDER #	DESCRIPTION	UOM
11-624-8	220114225	Size 8	12/Pk
11-624-9	220114235	Size 9	12/Pk
11-624-10	220100545	Size 10	12/Pk
11-624-11	220114195	Size 11	12/Pk

⚠ WARNING: Cancer and Reproductive Harm - www.P65Warnings.ca.gov



11-541

Ansell

HyFlex® 11-541 Ultralight Duty Gloves

- » Ultralight weight glove that offers unparalleled dexterity and refined mobility
- » ZONZ knitting technology uses selected yarns and varying stitch designs to tailor overall glove fit to enhance hand movement for higher dexterity and reduced fatigue
- » Silicone free design is paint and finish process friendly
- » Dirt masking palm for longer wear times

ITEM #	ORDER #	DESCRIPTION	UOM
11-541-7	220100105	Size 7	12/Pk
11-541-8	220100125	Size 8	12/Pk
11-541-9	220100135	Size 9	12/Pk
11-541-10	220100195	Size 10	12/Pk
11-541-11	220115665	Size 11	12/Pk

⚠ WARNING: Cancer and Reproductive Harm - www.P65Warnings.ca.gov



80-813

Ansell

ActivArmr® 80-813 Flame Resistant Gloves

- » Glove materials are arc and flame resistant, providing protection even after multiple launderings
- » Meets FR Testing CGSB 155.20-2000, Hazard/Risk Category (HRC) Level 2 Arc Flash Protection (ATPV) 12 cal/cm2 and ANSI Abrasion Level 4
- » Ergonomic design, superior comfort, dexterity and flexibility based on patented technology
- » Thin 13g knitted liner with Kevlar® increases productivity and safety compliance
- » Proprietary soft foam coating ensures a secure grip in wet, oily and dry environments

ITEM #	ORDER #	DESCRIPTION	UOM
80-813-9	220118155	Size 9	12/Pk
80-813-10	220118165	Size 10	12/Pk
80-813-11	220118175	Size 11	12/Pk



Cut-Resistant



KV13A

Honeywell Perfect Fit Gloves

- » 100% Kevlar® seamless lightweight knit glove
- » 13-gauge glove offers a level 2 ANSI ASTM cut protection, while providing excellent dexterity

ITEM #	ORDER #	DESCRIPTION	UOM
KV13A	341514345	One Size Fits All	12/Pk



KV18A-100-50

Honeywell Junk Yard Dog® Gloves

- » Kevlar® brand fiber seamless construction which offers excellent cut and abrasion resistance
- » Premium leather palm provides solid abrasion and puncture resistance
- » Durable with improved grip in wet and oily applications
- » ANSI Cut Level 3

ITEM #	ORDER #	DESCRIPTION	UOM
KV18A-100-50	341514411	One Size Fits All	PR

⚠️ WARNING: Cancer and Reproductive Harm - www.P65Warnings.ca.gov



Industrial Impact Rigger Cut 5 Gloves

- » Glove features IVE™ patent pending optical technology that extends the field of visual recognition
- » Proven maximum coverage impact protection on fingers, thumb, knuckles and metacarpal bones
- » Airprene cuff and reflective fabric for night time visibility
- » Glove palm features Duraclad® reinforced palm for grip, reinforced rope channel and thumb with EN388 cut level 5 palm liner

ITEM #	ORDER #	DESCRIPTION	UOM
INDI-RC5-02-S	C34802561	Small	PR
INDI-RC5-03-M	C34802571	Medium	PR
INDI-RC5-04-L	C34802591	Large	PR
INDI-RC5-05-XL	C34802601	XLarge	PR
INDI-RC5-06-XXL	C34802621	XXLarge	PR



INDI-RC5



97432



KleenGuard* G60 Purple Nitrile Gloves

- » Ultra-High Molecular Weight Polyethylene (HMPE) fiber enhances breathability and protection
- » EN388 and ANSI Cut Level 3 with CPPT of 1150 grams
- » Ambidextrous design improves cost-in-use
- » Foam nitrile-coated finger tips with dotted palm for grip

ITEM #	ORDER #	DESCRIPTION	UOM
97432	15407432	Size 9/Large	12/Cs
97433	15407433	Size 10/XLarge	12/Cs



Cut-Resistant



3437

Cut-Less 3437 with Dyneema® Knit Gloves

- » Cut-Less ring spun seamless knit glove with dark gray polyurethane palm coating
- » Dyneema® Diamond Technology offers the leading combination of cut protection, comfort and durability
- » At pound-for-pound 15X stronger than steel, Dyneema® Diamond Technology is the world's strongest fiber
- » EN Cut Level 5 and ANSI Cut Level A3

ITEM #	ORDER #	DESCRIPTION	UOM
3437/S	337917585	Small	12/Pk
3437/M	337917595	Medium	12/Pk
3437/L	337917605	Large	12/Pk
3437/XL	337917615	XLarge	12/Pk
3437/XXL	337917625	XXLarge	12/Pk

WARNING: Cancer and Reproductive Harm - www.P65Warnings.ca.gov



37-1300

Cut-Less 37-1300 Diamond® Knit Gloves

- » Cut-Less Diamond® ring spun seamless knit glove with soft gray polyurethane palm coating
- » Dyneema® Diamond Technology offers the leading combination of cut protection, comfort and durability
- » At pound-for-pound 15X stronger than steel, Dyneema® Diamond Technology is the world's strongest fiber
- » EN Cut Level 3 and ANSI Cut Level A2

ITEM #	ORDER #	DESCRIPTION	UOM
37-1300/S	337901065	Small	12/Pk
37-1300/M	337901055	Medium	12/Pk
37-1300/L	337901045	Large	12/Pk
37-1300/XL	337901075	XLarge	12/Pk
37-1300/2XL	337901085	XXLarge	12/Pk

WARNING: Cancer and Reproductive Harm - www.P65Warnings.ca.gov



35-1305

Cut-Less 35-1305 Watchdog® Polyurethane Coated Gloves

- » Cut-Less Watchdog® seamless knit glove, black polyurethane palm coating
- » 13-gauge, seamless knit glove with KorPlex® cut resistant technology
- » Pre-curved to minimize hand fatigue
- » EN Cut Level 3 and ANSI Cut Level A2

ITEM #	ORDER #	DESCRIPTION	UOM
35-1305/XS	337903215	XSmall	12/Pk
35-1305/S	337927205	Small	12/Pk
35-1305/M	337927215	Medium	12/Pk
35-1305/L	337900905	Large	12/Pk
35-1305/X1	337900915	XLarge	12/Pk
35-1305/X2	337900925	XXLarge	12/Pk
35-1305/X3	337903225	XXXLarge	12/Pk

WARNING: Cancer and Reproductive Harm - www.P65Warnings.ca.gov



N9674

MCR N9674 Ninja® X Gloves

- » 15-gauge black Nylon/Lycra® blend shell
- » Bi-Polymer palm and fingertips coated
- » Great dexterity and sense of touch
- » Comfortable, cool and treated with Actifresh®
- » ANSI Abrasion Level 4

ITEM #	ORDER #	DESCRIPTION	UOM
N9674S	331480031	Small	PR
N9674M	331496851	Medium	PR
N9674L	331496741	Large	PR
N9674XL	331496841	X-Large	PR

WARNING: Cancer and Reproductive Harm - www.P65Warnings.ca.gov



Cut-Resistant



92720NF



MCR 92720NF Cut Pro™ Black Gloves

- » 10-gauge black HPPE and steel shell
- » Shell is coated on the palm and fingers with soft black nitrile foam
- » Black color hides soiling
- » ANSI Cut Level A6, ANSI ABR Level 4 and ANSI Puncture Level 4

ITEM #	ORDER #	DESCRIPTION	UOM
92720NFL	331487151	Large	PR
92720NFXL	331487161	XLarge	PR

⚠ WARNING: Cancer and Reproductive Harm - www.P65Warnings.ca.gov



92720HV



MCR 92720HV Cut Pro™ Hi-Vis Gloves

- » 10 gauge hi-visibility lime HPPE / steel shell
- » Hi-visibility orange soft nitrile foam on palm and fingers
- » Outstanding cut and abrasion protection
- » ANSI Cut Level A6, ANSI ABR Level 6 and ANSI Puncture Level 4

ITEM #	ORDER #	DESCRIPTION	UOM
92720HVM	331445321	Medium	PR
92720HVL	331445331	Large	PR
92720HVXL	331445341	XLarge	PR

⚠ WARNING: Cancer and Reproductive Harm - www.P65Warnings.ca.gov



9761R



MCR 9761R Predator® Gloves

- » Fully coated rough premium nitrile coating
- » Soft Jersey Lining
- » Component materials comply with all relevant federal regulations for food contact
- » ANSI Cut Level A3, ANSI ABR Level 4 and ANSI Puncture Level 3

ITEM #	ORDER #	DESCRIPTION	UOM
9761RS	331420885	Small	PR
9761RM	331497675	Medium	PR
9761RL	331419855	Large	PR
9761RXL	331497665	XLarge	PR

⚠ WARNING: Cancer and Reproductive Harm - www.P65Warnings.ca.gov



9672



MCR 9672 Diamond Tech PU Gloves

- » 13-gauge salt and pepper DSM Certified Dyneema® blended shell
- » Gray polyurethane coated palm and fingertips
- » CE 4341
- » Cool and comfortable
- » ANSI Cut Level A3, ANSI ABR Level 5 and ANSI Puncture Level 2

ITEM #	ORDER #	DESCRIPTION	UOM
9672-L	331497025	Large	12/Pk
9672-XL	331497035	XLarge	12/Pk

⚠ WARNING: Cancer and Reproductive Harm - www.P65Warnings.ca.gov



Cut-Resistant



KV300



SHOWA® KV300 Gloves

- » 10-gauge seamless liner made with Kevlar®
- » Rough grip natural rubber palm coating
- » ANSI cut level A3
- » Low thermal conductivity and thermal shrinkage

ITEM #	ORDER #	DESCRIPTION	UOM
KV300L-09	384123175	Size 9/Large	12/Pk
KV300XL-10	384123185	Size 10/XLarge	12/Pk

⚠ WARNING: Cancer and Reproductive Harm - www.P65Warnings.ca.gov



541



SHOWA® 541 Gloves

- » Flexible, light glove providing effective protection against cuts and very resistant to abrasion
- » ANSI Level A3 cut-resistance
- » PU palm protects from oils and abrasion while remaining elastic and breathable
- » Designed for easy movement and continuous wear

ITEM #	ORDER #	DESCRIPTION	UOM
541-S	384101795	Size 7/Small	12/Pk
541-M	384101785	Size 8/Medium	12/Pk
541-L	384101775	Size 9/Large	12/Pk
541-XL	384101805	Size 10/X-Large	12/Pk
541-XXL	384115415	Size 11/2X-Large	12/Pk

⚠ WARNING: Cancer and Reproductive Harm - www.P65Warnings.ca.gov



S-TEX350



SHOWA® S-TEX350 Gloves

- » Rough nitrile palm coating
- » ANSI Level A4 cut-resistance
- » Effective grip in greasy and dry handling conditions
- » Seamless knit and open back design
- » Fluorescent high visibility

ITEM #	ORDER #	DESCRIPTION	UOM
S-TEX350-07	384150165	Size 7/Small	12/Pk
S-TEX350-08	384150155	Size 8/Medium	12/Pk
S-TEX350-09	384150135	Size 9/Large	12/Pk
S-TEX350-10	384150145	Size 10/X-Large	12/Pk

⚠ WARNING: Cancer and Reproductive Harm - www.P65Warnings.ca.gov



KHD-CR



M-Pact® KHD-CR Knit CR5A5 Gloves

- » 13-gauge machine knit shell delivers CE Level 5 and ANSI A5 cut resistance
- » Thermoplastic Rubber (TPR) coated for impact and pinch point protection
- » Double-dipped sand nitrile palm with D30® padding
- » Extended cuff
- » Machine washable

ITEM #	ORDER #	DESCRIPTION	UOM
KHD-CR-009	C24527291	Medium	PR
KHD-CR-010	C24527301	Large	PR
KHD-CR-011	C24527311	XLarge	PR



Cut-Resistant



WELLS LAMONT
Industrial

FlexTech™ Y9290 Gloves

Y9290

- » Lightweight cut resistant knit shell with double coating
- » Sandy nitrile coated palm and fingertips affords excellent gripping
- » Full NBR coating provides an extra layer of protection against liquids
- » ANSI Puncture Level 4, ANSI Cut Level 4

ITEM #	ORDER #	DESCRIPTION	UOM
Y9290M	416496525	Medium	12/Pk
Y9290L	416496535	Large	12/Pk
Y9290XL	416496545	XLarge	12/Pk



WELLS LAMONT
Industrial

Y9216

FlexTech™ Y9216 Gloves

- » Seamless machine knit cut resistant shell provides all-day comfort and protection
- » Sandy nitrile palm coating delivers improved grip in wet and oily applications
- » Machine washable for longer service life
- » ANSI Cut Level 5, A7

ITEM #	ORDER #	DESCRIPTION	UOM
Y9216XS	416492135	XSmall	12/Pk
Y9216S	416492145	Small	12/Pk
Y9216M	416492155	Medium	12/Pk
Y9216L	416492165	Large	12/Pk
Y9216XL	416492175	XLarge	12/Pk
Y9216XXL	416492185	XXLarge	12/Pk



WELLS LAMONT
Industrial

Y9275

FlexTech™ Y9275 Gloves

- » High Performance Polyethylene fibers (HPPE) and gray nylon blend
- » Polyurethane gray palm coating provides excellent grip and tactility
- » Provides a good balance of comfort, dexterity and cut resistance
- » Launderable, ANSI level 2, A2

ITEM #	ORDER #	DESCRIPTION	UOM
Y9275XS	416492755	XSmall	12/Pk
Y9275S	416492765	Small	12/Pk
Y9275M	416492795	Medium	12/Pk
Y9275L	416492805	Large	12/Pk
Y9275XL	416492815	XLarge	12/Pk
Y9275XXL	416409055	XXLarge	12/Pk



WELLS LAMONT
Industrial

Y9296

Vis-Tech Y9296 Gloves

- » Hi-Vis cut resistant shell provides a high level of protection and awareness in tough environments
- » Sandy Nitrile palm coating provides excellent grip
- » Knit wrist construction prevents dirt and debris from entering the glove
- » ANSI Cut Level 4, A4

ITEM #	ORDER #	DESCRIPTION	UOM
Y9296M	416411995	Medium	12/Pk
Y9296L	416412005	Large	12/Pk
Y9296XL	416412015	XLarge	12/Pk

WARNING: Cancer and Reproductive Harm - www.P65Warnings.ca.gov



Cut-Resistant

WELLS LAMONT
Industrial

Handguard II® Gloves

- » 5.5-gauge heavy duty knit cut resistant glove with Honeywell Spectra® fibers and stainless steel
- » CFR 21 – approved for food contact
- » ANSI Cut Level 5, A7
- » Ambidextrous, prewashed and preshrunk



333023

ITEM #	ORDER #	DESCRIPTION	UOM
333023	416430231	Medium	EA
333025	416430251	Large	EA
333027	416430271	XLarge	EA

WELLS LAMONT
Industrial

Knifehandler® Gloves

- » 7-gauge cut resistant glove with patented combination of fibers with Honeywell Spectra® fibers and stainless steel
- » Breathable, form-fitting with excellent thermal properties
- » CFR 21 – approved for food contact
- » ANSI Cut Level 5, A9
- » Ambidextrous, prewashed and preshrunk



333370

ITEM #	ORDER #	DESCRIPTION	UOM
333370	416433511	Small	EA
333372	416433521	Medium	EA
333374	416433531	Large	EA

WELLS LAMONT
Industrial

Whizard Metal Mesh Hand Gloves

- » Stainless steel, ergonomically designed gloves provide superior cut and puncture protection
- » All Whizard® mesh gloves come with a metal serial number tag, which helps with reissuance and sizing information
- » Made with 4 mm wire micro plasma welded rings using 0.5 mm wire, have no gaps to trap soil that can feed bacterial growth
- » Ambidextrous – turn inside out for the other hand



CM0300

ITEM #	ORDER #	DESCRIPTION	UOM
CM030000	416400551	XXSmall	EA
CM030001	416452591	XSmall	EA
CM030002	416452601	Small	EA
CM030003	416452611	Medium	EA
CM030004	416452621	Large	EA
CM030005	416452631	XLarge	EA
CM030006	416452581	XXLarge	EA

Cut-Resistant Sleeves



AS019S

HexArmor

HexArmor® 19" Protective Arm Sleeve

- » SuperFabric® brand material for some of the highest cut-resistance available on the market, ANSI/ISEA level A7 cut protection
- » Innovative industrial puncture protection from wires, metal, wood, and glass from wrist to bicep
- » Won't fall down like knit sleeves, lightweight and cooler than knit or leather alternatives
- » Neoprene thumb loop and sleeve clip
- » Launderable

ITEM #	ORDER #	SIZE	UOM
AS019S-S	E28801061	7/Small	EA
AS019S-M	E28822341	8/Medium	EA
AS019S-L	E28822301	9/Large	EA
AS019S-XL	E28822311	10/X-Large	EA



AG8TW

HexArmor

HexArmor® 8" Needle-Resistant Arm Guard

- » Needlestick resistance available provided by the layering of SuperFabric® brand material, ANSI/ISEA needlestick level 2
- » High level of cut-resistance on noted enhanced areas, ANSI/ISEA cut level A8
- » Won't fall down like knit sleeves, lightweight and cooler than knit or leather alternatives
- » Lasts 13 times longer than competitive sleeves
- » Launderable

ITEM #	ORDER #	SIZE	UOM
AG8TW-M	E28801411	8/Medium	EA
AG8TW-L	E28801431	9/Large	EA
AG8TW-XL	E28801401	10/X-Large	EA
AG8TW-2X	E28801451	11/2X-Large	EA



AG10009S

HexArmor

HexArmor® 9" Arm Guard

- » SuperFabric® brand material for some of the highest cut-resistance available on the market, ANSI/ISEA level A7 cut resistance
- » Innovative industrial puncture protection from wires, metal, wood, and glass over entire forearm
- » Won't fall down like knit sleeves, lightweight and cooler than knit or leather alternatives
- » Lasts 13 times longer than competitive sleeves
- » Spandex wrist insert with thumbhole
- » Launderable

ITEM #	ORDER #	SIZE	UOM
AG10009S-S	E28896221	7/Small	EA
AG10009S-M	E28810091	8/Medium	EA
AG10009S-L	E28822321	9/Large	EA
AG10009S-XL	E28801051	10/X-Large	EA



9218M13



MCR Cut Pro™ Sleeve

- » 18", 13-gauge HPPE/synthetic sleeves
- » Allows excellent manual dexterity
- » High comfort level you will appreciate wearing
- » Seamless knit liner, sleeve width 5.25"
- » Abrasion and cut resistance, CE 4342 and ANSI Cut Level 2

ITEM #	ORDER #	DESCRIPTION	UOM
9218M13	331492181	18" Sleeve	PR



Cut-Resistant Sleeves



WELLS LAMONT
Industrial

135364

Whizard® Z40 Armguard

- » Offers a wide upper arm opening for bigger biceps
- » Unique knit structure allows breathing
- » Reversible for extended wear
- » Clip allows you to attach sleeve to clothing and hold in place
- » ANSI Cut Level A6

ITEM #	ORDER #	DESCRIPTION	UOM
135364	416453641	22" Wide Sleeve	EA



WELLS LAMONT
Industrial

333477

Whizard® Medium Duty Armguard

- » Gray armguard provides strength, not bulk and good cut resistance
- » Features Honeywell Spectra® Fiber, outstanding wear for a long service life
- » Prewashed and preshrunk for a close fit
- » ANSI Cut Level 4, A7

ITEM #	ORDER #	DESCRIPTION	UOM
333477	41645036	10" Forearm Sleeve	EA



WELLS LAMONT
Industrial

SK-22HKSC

Whizard® Metalguard® Sleeve

- » Unique knit sleeve made from a patented combination of metalguard yarn & Kevlar®
- » Knit structure allows for air circulation
- » Knitted using strong Kevlar material
- » ANSI Cut Level A5

ITEM #	ORDER #	DESCRIPTION	UOM
SK-22HKSC	416422221	22" Sleeve	EA



9318D10



MCR 9318D10 Cut Pro™ Sleeve

- » 18", 7-gauge Dyneema® Diamond Technology sleeve
- » FDA-accepted materials for use in food processing applications
- » Micro-Particle Boosted High Strength Fiber Offering Cool-Touch Comfort and Maximum Durability
- » ANSI Abrasion Level 4 and ANSI Cut Level 2

ITEM #	ORDER #	DESCRIPTION	UOM
9318D10	331441831	18" Sleeve	EA



SKC-18H

WELLS LAMONT
Industrial

SKC Sleeves

- » Made from a patented combination of high performance materials and flame-resistant fibers
- » Blousy fit allows superior comfort and breathability
- » Elastic on both ends allows sleeve to stay in place
- » Available with or without a thumb hole
- » ANSI Cut Level A3

ITEM #	ORDER #	DESCRIPTION	UOM
SKC-10	416412151	10" Sleeve	EA
SKC-14	416412161	14" Sleeve	EA
SKC-18	416412171	18" Sleeve	EA
SKC-18H	416418181	18" Sleeve with Thumb Hole	EA
SKC-24	416412181	24" Sleeve	EA
SKC-24H	416418241	24" Sleeve with Thumb Hole	EA



Chemical-Resistant

Ansell

Sol-Vex® Green Nitrile Immersion Gloves

- » High performance nitrile compound provides an outstanding combination of chemical resistance and strength
- » Offers superior snag, puncture and abrasion protection over rubber or neoprene gloves
- » Suitable for heavy duty cleaning applications
- » High levels of flexibility, comfort and dexterity
- » Won't swell, weaken or degrade and does not promote contact dermatitis
- » All Sol-Vex® gloves comply with FDA food handling requirements (21 CFR 177.2600)



37-175

ITEM #	ORDER #	DESCRIPTION	UOM
Unlined – 13" Long			
37-155-8	220104295	15 Mil Thick/Size 8	12/Pk
37-155-9	220104305	15 Mil Thick/Size 9	12/Pk
37-155-10	220155105	15 Mil Thick/Size 10	12/Pk
Unlined – 15" Long			
37-165-9	220104335	22 Mil Thick/Size 9	12/Pk
37-165-10	220165105	22 Mil Thick/Size 10	12/Pk

⚠ WARNING: Cancer and Reproductive Harm - www.P65Warnings.ca.gov

ITEM #	ORDER #	DESCRIPTION	UOM
Flock Lined – 13" Long			
37-175-8	220104365	15 Mil Thick/Size 8	12/Pk
37-175-9	220104375	15 Mil Thick/Size 9	12/Pk
37-175-10	220175105	15 Mil Thick/Size 10	12/Pk



8-352

Ansell

Scorpio® Neoprene-Coated Gloves

- » Heavy duty protection against a wide range of chemicals
- » Interlock knit cotton two-piece lining for comfort and easy donning and doffing
- » Textured finish provides excellent grip on wet and slippery materials with great flexibility
- » Snug fit with high degree of fingertip sensitivity
- » 12" length, gauntlet cuff

ITEM #	ORDER #	DESCRIPTION	UOM
8-352-9	220111925	Size 9	12/Pk
8-352-10	220111895	Size 10	12/Pk

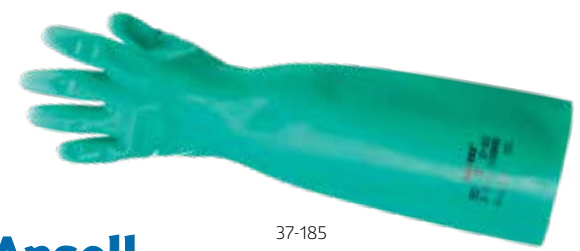

37-185

Ansell

AlphaTec® Solvex® Gloves

- » High performance nitrile compound provides an outstanding combination of chemical resistance and strength
- » Offers a far superior snag, puncture and abrasion protection compared with rubber or neoprene gloves
- » High levels of flexibility, comfort and dexterity
- » Will not swell, weaken or degrade, and does not promote contact dermatitis
- » Suitable for heavy-duty cleaning applications

ITEM #	ORDER #	DESCRIPTION	UOM
37-185-8	22010439	Size 8	12/Pk
37-185-9	22010440	Size 9	12/Pk
37-185-10	22018510	Size 10	12/Pk



Chemical-Resistant



Honeywell
NORTH

LA132G

NitriGuard Plus™ Unsupported Nitrile Gloves

- » Nitrile formulation contains no latex proteins which could cause allergic reactions and will not swell, sag or weaken from fat absorption
- » Resistant to chemicals, cuts, snags, abrasions and punctures
- » Complies with USDA and FDA regulations, 21 CFR, for use in food processing

ITEM #	ORDER #	DESCRIPTION	UOM
15 Mil with Flocked Liner			
LA132G/9	347618585	Size 9	12/Pk
LA132G/10	347618545	Size 10	12/Pk



Honeywell
NORTH

B131R

North® B131 Butyl Unsupported Gloves

- » Butyl has the highest permeation resistance to gas and water vapor, highly resistant to ketones (MEK, MIBL, acetone) and esters (tricresyl phosphate, amyl acetate, ethyl acetate)
- » 11" length, 13 mil, rough grip

ITEM #	ORDER #	DESCRIPTION	UOM
B131R/8	347606251	Size 8	PR
B131R/9	347606261	Size 9	PR
B131R/10	347606221	Size 10	PR



SSG

Honeywell
NORTH

Silver Shield® Gloves

- » Resistant to over 280 different chemicals including alcohols, aliphatics, aromatics, chlorines, ketones and esters
- » Economical, most commonly used as a liner glove for added protection
- » Gloves are ambidextrous, 16" long, 2.7 mil

ITEM #	ORDER #	DESCRIPTION	UOM
SSG/9	347670995	Size 9	10/Pk
SSG/10	347670945	Size 10	10/Pk
SSG/11	347670955	Size 11	10/Pk



727



SHOWA® Chemical-Resistant Nitrile Gloves

- » Provides chemical resistance against a broad range of solvents, oils, animal fats and other chemicals
- » Mechanical resistance
- » Bisque finish grip makes wet work easier and safer
- » Ergonomic design maximizes comfort, 13" length, 15 mil

ITEM #	ORDER #	DESCRIPTION	UOM
Unlined			
727-09	384127095	Size 9	12/Pk
727-10	384127105	Size 10	12/Pk
Flock-Lined			
730-09	384102665	Size 9	12/Pk
730-10	384102675	Size 10	12/Pk

WARNING: Cancer and Reproductive Harm - www.P65Warnings.ca.gov

Chemical-Resistant



SHOWA® CHM Gloves

- » Engineered with a neoprene-over-natural rubber construction
- » Comfortable, flexible and tactile sensitive
- » Embossed grip that encourages run off of fluids
- » 100% cotton flock lining enhances comfort
- » Good resistance to a broad range of chemicals

ITEM #	ORDER #	DESCRIPTION	UOM
CHMS-07	384100455	Size 7/Small	12/Pk
CHMM-08	384100445	Size 8/Medium	12/Pk
CHML-09	384100435	Size 9/Large	12/Pk
CHMXL-10	384100515	Size 10/XLarge	12/Pk



CHM

⚠ WARNING: Cancer and Reproductive Harm - www.P65Warnings.ca.gov



6780R



SHOWA® Neoprene Gloves

- » Cotton liner helps keep you cool and comfortable in hot conditions or warm in cold conditions
- » Provides protection against acids, caustics, oils, greases and many solvents
- » Excellent all-around protection against physical hazards such as abrasion and cut
- » Rough finish is excellent for applications where a good wet grip is required

ITEM #	ORDER #	DESCRIPTION	UOM
6780R-10	384102085	12" Gauntlet/Large	12/Pk
6784R-10	384102125	14" Gauntlet/Large	12/Pk
6797R-10	384110105	Elbow Length Gauntlet/Large	12/Pk

⚠ WARNING: Cancer and Reproductive Harm - www.P65Warnings.ca.gov

WELLS LAMONT
Industrial

PERM-RUFF PVC Gloves

- » Highly recommended for high abrasive uses
- » Full PVC coating protects from a wide range of hazardous chemicals
- » PVC chip surface provides superior wet/oily grip
- » Interlocked liner for easy laundering

ITEM #	ORDER #	DESCRIPTION	UOM
PR4112L	416402235	12" Length/Large	12/Pk

⚠ WARNING: Cancer and Reproductive Harm - www.P65Warnings.ca.gov



PR4112



Disposable

NSM400



AMBITEX® N400 3 Mil Blue Nitrile Powder-Free Glove

- » Lightweight with textured surface for improved grip
- » Meets or exceeds ASTM and FDA examination glove standards
- » Passes ASTM F1671 test standards for resistance to penetration of blood borne pathogens
- » Not made with natural rubber latex
- » Complies with 21 CFR parts 170-199 for food contact

ITEM #	ORDER #	SIZE	UOM
NSM400	510200995	Small	100/Bx
NMD400	510200975	Medium	100/Bx
NLG400	510203995	Large	100/Bx
NXL400	510204005	XLarge	100/Bx

NSM6201



AMBITEX® N6201 6 Mil Blue Nitrile Powder-Free Glove

- » Fully textured for firm grip
- » Resistance to many chemicals
- » Heavyweight protection for industrial applications

ITEM #	ORDER #	SIZE	UOM
NSM6201	510201175	Small	100/Bx
NMD6201	510201185	Medium	100/Bx
NLG6201	510201195	Large	100/Bx
NXL6201	510201205	XLarge	100/Bx



NSM5201

AMBITEX® N5201 4 Mil Blue Nitrile Powder-Free Glove

- » Textured surface for improved grip
- » Resists a variety of chemicals and animal fats
- » Not made with natural rubber latex
- » Complies with 21 CFR parts 170-199 for food contact

ITEM #	ORDER #	SIZE	UOM
NSM5201	510252115	Small	100/Bx
NMD5201	510252125	Medium	100/Bx
NLG5201	510252135	Large	100/Bx
NXL5201	510252145	XLarge	100/Bx

NSM200BLK



AMBITEX® N200 4 Mil Black Nitrile Powder-Free Glove

- » Hides dirt and stains
- » Rich black color provides sharp contrast
- » Not made with natural rubber latex
- » Textured surface for improved grip

ITEM #	ORDER #	SIZE	UOM
NSM200BLK	510201265	Small	100/Bx
NMD200BLK	510201275	Medium	100/Bx
NLG200BLK	510201285	Large	100/Bx
NXL200BLK	510201295	XLarge	100/Bx

LSM5201



AMBITEX® L5201 4 Mil Cream Latex Powder-Free Glove

- » Natural fit and comfort
- » Textured surface for improved grip
- » Complies with 21 CFR parts 170-199 for food contact

ITEM #	ORDER #	SIZE	UOM
LSM5201	510200225	Small	100/Bx
LMD5201	510252015	Medium	100/Bx
LLG5201	510200215	Large	100/Bx
LXL5201	510201215	XLarge	100/Bx



Disposable



SU-690-L

MICROFLEX®

SU-690 Supreno® SE Heavy-Duty Nitrile Blue Exam Glove

- » Textured fingers for a strong, efficient grip
- » Polymer coating assures easy donning
- » Exceptional barrier integrity with 0.65 AQL for allowable pinholes
- » Powder-free, not made from natural rubber
- » Palm thickness: 4.3 mils

ITEM #	ORDER #	SIZE	UOM
SU-690-XS	098900435	XSmall	100/Bx
SU-690-S	098900445	Small	100/Bx
SU-690-M	098900455	Medium	100/Bx
SU-690-L	098900465	Large	100/Bx
SU-690-XL	098900475	XLarge	100/Bx



N193

MICROFLEX®

N19 Cobalt® Blue Nitrile Exam Glove

- » Fully textured for enhanced grip
- » Consistent, dependable protection
- » Enhanced tactile sensitivity
- » Powder-free, not made from natural rubber
- » Palm thickness: 3.9 mils

ITEM #	ORDER #	SIZE	UOM
N191	098911915	Small	100/Bx
N192	098911925	Medium	100/Bx
N193	098911935	Large	100/Bx
N194	098911945	XLarge	100/Bx



MK-296-L

MICROFLEX®

MK-296 Midnight® Nitrile Black Exam Glove

- » Distinctive black color hides stains and provides contrast for improved visibility
- » Fully textured, with high tensile strength and flexibility
- » Non-foaming for easy handling of objects in wet environments
- » Powder-free, not made from natural rubber
- » Palm thickness: 4.7 mils

ITEM #	ORDER #	SIZE	UOM
MK-296-XS	098902925	XSmall	100/Bx
MK-296-S	098902935	Small	100/Bx
MK-296-M	098902975	Medium	100/Bx
MK-296-L	098902945	Large	100/Bx
MK-296-XL	098902955	XLarge	100/Bx
MK-296-XXL	098902965	2XLarge	100/Bx



N873

MICROFLEX®

N87 Integra® EC Nitrile Blue Exam Glove with Extended Cuff

- » Enhanced thickness in the palm and finger for added durability
- » Extended length provides superior protection in high-risk conditions
- » Fully textured, Powder-free
- » Palm thickness: 7.9 mils

ITEM #	ORDER #	SIZE	UOM
N871	098900665	Small	50/Bx
N872	098900675	Medium	50/Bx
N873	098900685	Large	50/Bx
N874	098900695	XLarge	50/Bx
N875	098900705	2XLarge	50/Bx



Disposable



N273

MICROFLEX®

N27 Blue Nitrile Disposable Glove

- » Fully textured cobalt blue nitrile disposable glove
- » Enhanced grip in wet and dry conditions
- » Perfect for general purpose tasks
- » Powder-free, not made from natural rubber
- » Palm thickness: 3.9 mils

ITEM #	ORDER #	SIZE	UOM
N271	098902715	Small	100/Bx
N272	098902725	Medium	100/Bx
N273	098902735	Large	100/Bx
N274	098902745	XLarge	100/Bx



N643

MICROFLEX®

N64 Onyx® Black Nitrile Exam Glove

- » Deep black color masks stains and makes viewing lighter objects easy
- » Textured fingers for consistent grip
- » Suitable for use in a wide range of industries
- » Powder-free, not made from natural rubber
- » Silicone free
- » Palm thickness: 3.5 mils

ITEM #	ORDER #	SIZE	UOM
N641	098900215	Small	100/Bx
N642	098906425	Medium	100/Bx
N643	098906435	Large	100/Bx
N644	098906445	XLarge	100/Bx



N203

MICROFLEX®

N20 Nitrile Blue Disposable Glove

- » Fully textured nitrile disposable glove
- » Cost-effective protection
- » Fully textured for enhanced grip
- » Powder-free, not made from natural rubber
- » Palm thickness: 3.9 mils

ITEM #	ORDER #	SIZE	UOM
N201	098900315	Small	100/Bx
N202	098900325	Medium	100/Bx
N203	098900335	Large	100/Bx
N204	098900345	XLarge	100/Bx



N863

MICROFLEX®

N86 Integra® Nitrile Blue Exam Glove

- » Enhanced thickness in the palm and finger for added durability
- » Fully textured
- » Powder-free, not made from natural rubber
- » Palm thickness: 6.7 mils

ITEM #	ORDER #	SIZE	UOM
N861	098900355	Small	50/Bx
N862	098900365	Medium	50/Bx
N863	098900375	Large	50/Bx
N864	098900385	XLarge	50/Bx



Disposable



MF-300-L

MICROFLEX®

MF-300 Diamond Grip® Latex Exam Glove

- » Durable cream natural rubber latex exam glove
- » Unique design with enhanced finger thickness
- » Textured fingertips for a more secure, confident grip
- » Polymer-coated interior for easy donning and a comfortable, dry feel
- » Powder-free
- » Palm thickness: 6.3 mils

ITEM #	ORDER #	SIZE	UOM
MF-300-S	098903015	Small	100/Bx
MF-300-M	098903025	Medium	100/Bx
MF-300-L	098903035	Large	100/Bx
MF-300-XL	098903045	XLarge	100/Bx



SG-375-LS

MICROFLEX®

SG-375 SafeGrip® Blue Latex Exam Glove with Extended Cuff

- » Three times thicker than standard latex gloves
- » Textured fingers for reliable grip
- » Powder-free, double chlorinated for easy donning
- » Meets or exceeds the emergency medical glove requirements of NFPA 1999
- » Palm thickness: 11 mils

ITEM #	ORDER #	SIZE	UOM
SG-375-S	098903755	Small	50/Bx
SG-375-M	098903765	Medium	50/Bx
SG-375-L	098903775	Large	50/Bx
SG-375-XL	098903785	XLarge	50/Bx



BD-1003-PF-L

MICROFLEX®

BD-1000-PF Black Dragon® Black Latex Exam Glove

- » Unique dark color assists in framing and focus
- » Fully textured black natural rubber latex
- » Versatile latex for multiple applications
- » Powder-free
- » Palm thickness: 4.7 mils

ITEM #	ORDER #	SIZE	UOM
BD-1001-PF-S	098900075	Small	100/Bx
BD-1002-PF-M	098900085	Medium	100/Bx
BD-1003-PF-L	098900095	Large	100/Bx
BD-1004-PF-XL	098900105	XLarge	100/Bx



EV-2050-L

MICROFLEX®

EV-2050 Evolution One® Latex Exam Glove

- » Fully textured cream natural rubber latex for a secure grip
- » Comfortable latex for extended wear
- » Powder-free
- » Palm thickness: 5.5 mils

ITEM #	ORDER #	SIZE	UOM
EV-2050-S	098920605	Small	100/Bx
EV-2050-M	098920615	Medium	100/Bx
EV-2050-L	098920625	Large	100/Bx
EV-2050-XLS	098920635	XLarge	100/Bx



Disposable



DGP-350-L

MICROFLEX®

DGP-350 Diamond Grip Plus® Latex Exam Glove

- » Fully textured cream natural rubber latex for a secure grip
- » Thick design for durable protection
- » Powder-free
- » Palm thickness: 5.1 mils

ITEM #	ORDER #	SIZE	UOM
DGP-350-S	098900545	Small	100/Bx
DGP-350-M	098900555	Medium	100/Bx
DGP-350-L	098900565	Large	100/Bx
DGP-350-XL	098900575	XLarge	100/Bx



NPG-888-L

MICROFLEX®

NPG-888 NeoPro® Green Neoprene Exam Glove

- » Neoprene exam glove with textured fingertips
- » Excellent splash protection
- » Tested for use with chemotherapy/cytotoxic drugs
- » Polymer coating for easy donning and doffing
- » Powder-free
- » Palm thickness: 5.1 mils

ITEM #	ORDER #	SIZE	UOM
NPG-888-S	098900495	Small	100/Bx
NPG-888-M	098900505	Medium	100/Bx
NPG-888-L	098900515	Large	100/Bx
NPG-888-XL	098900525	XLarge	100/Bx



25-101

Ansell

NeoTouch® 25-101 Neoprene Gloves

- » An alternative to natural rubber latex that protects against Type I allergies
- » Excellent resistance to acids, bases and alcohols
- » Exclusive formulation provides superior comfort
- » Exam grade
- » Food grade - complies with FDA food handling requirements (21 CFR 177.2600)

ITEM #	ORDER #	DESCRIPTION	UOM
25-101-S	22011518	Small,	100/Bx
25-101-M	22011517	Medium	100/Bx
25-101-L	22011512	Large	100/Bx
25-101-XL	22012514	XLarge	100/Bx



92-500

Ansell

TouchNTuff® 92-500 and 92-600 Nitrile Gloves

- » 100% nitrile, silicone-free
- » 3X the puncture resistance of standard latex or vinyl gloves
- » Combines excellent fingertip sensitivity with exceptional durability
- » Lightweight, gives a high level of protection against grease and oil
- » Comply with FDA food handling requirements (21 CFR 177.2600)

ITEM #	ORDER #	DESCRIPTION	UOM
Powdered			
92-500-L	220112655	Large	100/Bx
92-500-XL	220112665	XLarge	100/Bx
Powder-Free			
92-600-M	220112695	Medium	100/Bx
92-600-L	220112705	Large	100/Bx
92-600-XL	220112715	XLarge	100/Bx



Disposable



92-575

Ansell

TNT® 92-575 and 92-675 Nitrile Gloves

- » Durable, 5 mil nitrile gloves
- » Soft and comfortable
- » Textured fingers for exceptional grip
- » Ambidextrous
- » Comply with FDA food handling requirements (21 CFR 177.2600)

ITEM #	ORDER #	DESCRIPTION	UOM
Powdered			
92-575-L	220148195	Large	100/Bx
92-575-XL	220148205	XLarge	100/Bx
Powder-Free			
92-675-L	220126775	Large	100/Bx
92-675-XL	220126785	XLarge	100/Bx



Kleenguard* G10 Blue Nitrile Gloves

- » Textured fingertips with beaded cuff for easy donning
- » Light chemical splash protection
- » Not made with natural rubber latex, silicone-free
- » 6 mil thickness
- » 9.5" Long, ambidextrous, powder-free
- » Touchscreen capable
- » Meets Canadian requirements and U.S. FDA regulations for food handling applications



57371

ITEM #	ORDER #	DESCRIPTION	UOM
57371	154073715	Size 7/Small	100/Bx
57372	154073725	Size 8/Medium	100/Bx
57373	154073735	Size 9/Large	100/Bx
57374	154073745	Size 10/XLarge	90/Bx



Kimtech Pure* G3 NXT* Nitrile Gloves

- » Textured fingertips with beaded cuff for easy donning
- » Contain no natural rubber latex, static dissipative in use
- » 12" Long, ambidextrous, powder-free
- » Double-bagged with case liner. Packaged in an ISO Class 5 cleanroom
- » Meets AQL level of 1.5 for pinholes



62991

ITEM #	ORDER #	DESCRIPTION	UOM
62991	15400760	Small	CS
62992	15400761	Medium	CS
62993	15400762	Large	CS



Kimberly Clark* Purple Nitrile* Exam Gloves

- » Textured fingertips with beaded cuff for easy donning
- » Natural rubber latex-free
- » 6 mil thickness
- » 9.5" Long, ambidextrous, powder-free
- » Cleared for use in Chemotherapy



55082

ITEM #	ORDER #	DESCRIPTION	UOM
55082	154050825	Medium	100/Bx
55083	154050835	Large	100/Bx
55084	154050845	XLarge	90/Bx



Disposable



5055



Sensaguard™ 5055 and 5060 Latex Gloves

- » 5 mil, natural rubber latex
- » Component materials comply with all federal regulations for food contact
- » Industrial/food service grade
- » Smooth grip, rolled cuff
- » 9.5" Length, ambidextrous
- » Chlorinated

ITEM #	ORDER #	DESCRIPTION	UOM
Powder-Free			
5055-M	331450565	Medium	100/Bx
5055-L	331450575	Large	100/Bx
5055-XL	331450585	XLarge	100/Bx
Powdered			
5060-L	331450625	Large	100/Bx
5060-XL	331412095	XLarge	100/Bx

⚠ WARNING: Cancer and Reproductive Harm - www.P65Warnings.ca.gov



NK803ES



Nitri-Knit™ Supported Nitrile Gloves

- » Superior resistance to cuts, snags, abrasions and punctures
- » High resistance to solvents, caustics and animal fats
- » Interlock knit liner is soft and comfortable
- » 26" Length, elastic cuff
- » Complies with USDA and FDA regulations, 21 CFR, for use in food processing

ITEM #	ORDER #	DESCRIPTION	UOM
NK803ES/9	347620661	Size 9	PR
NK803ES/10	347620611	Size 10	PR



5020



Sensaguard™ 5020 Vinyl Gloves

- » 5 mil, clear powdered vinyl
- » Component materials comply with all federal regulations for food contact
- » Industrial grade
- » Rolled cuff
- » Latex-free
- » 9.5" Length, ambidextrous

ITEM #	ORDER #	DESCRIPTION	UOM
5020-M	331450165	Medium	100/Bx
5020-L	331450175	Large	100/Bx
5020-XL	331450185	XLarge	100/Bx

⚠ WARNING: Cancer and Reproductive Harm - www.P65Warnings.ca.gov



6606-20



Derma-Lite™ Nitrile Gloves

- » 5 mil powder-free exam grade nitrile
- » Non-latex
- » Textured grip provides enhanced gripping power
- » Extraordinary strength and puncture resistance

ITEM #	ORDER #	DESCRIPTION	UOM
6606-20	G73506205	Small	100/Bx
6607-20	G73507205	Medium	100/Bx
6608-20	G73500535	Large	100/Bx
6609-20	G73566095	XLarge	100/Bx



Disposable



Astro-Grip™ Nitrile Gloves

- » 7 mil powder-free exam grade nitrile
- » Dual-sided scale textured surface for superior grip
- » High visibility orange color
- » Non-latex
- » Exceptional chemical and puncture resistance
- » Maximum comfort for extended wear



66572

ITEM #	ORDER #	DESCRIPTION	UOM
66572	G73565255	Medium	100/Bx
66573	G73565265	Large	100/Bx
66574	G73565275	XLarge	100/Bx
66575	G73565285	XXLarge	100/Bx



Derma-Max™ Nitrile Gloves

- » 8 mil powder-free exam grade nitrile
- » Extra long 12" length
- » Textured grip with beaded cuff
- » Rolled cuff for easy on/off
- » Excellent sensitivity
- » Durable and comfortable



6606-40

ITEM #	ORDER #	DESCRIPTION	UOM
6606-40	G73506405	Small	50/Bx
6607-40	G73507405	Medium	50/Bx
6608-40	G73508405	Large	50/Bx
6609-40	G73509405	XLarge	50/Bx
6610-40	G73510405	XXLarge	50/Bx



66521



Derma-Med™ Nitrile Gloves

- » 4 mil powder-free exam grade nitrile
- » Non-latex
- » Texture provides firm grip in any weather condition
- » Beaded cuff for easy donning
- » Provides comfort and dexterity, reduces hand fatigue

ITEM #	ORDER #	DESCRIPTION	UOM
66521	G73565215	Small	100/Bx
66522	G73566525	Medium	100/Bx
66523	G73565235	Large	100/Bx
66524	G73566245	XLarge	100/Bx



Raven™ Nitrile Gloves

- » 6 mil powder-free exam grade nitrile
- » Non-latex
- » Textured for excellent chemical resistance and great grip
- » Outstanding strength, wear and dexterity
- » Comfortable for wear



66516

ITEM #	ORDER #	DESCRIPTION	UOM
66516	G73565165	Small	100/Bx
66517	G73565175	Medium	100/Bx
66518	G73565185	Large	100/Bx
66519	G73565195	XLarge	100/Bx
66520	G73565205	XXLarge	100/Bx



Disposable



650-1001

Dyna Grip™ Latex Gloves

- » 7 mil powder-free exam grade latex
- » Textured surface for grip
- » Beaded cuff for easy on/off
- » Easy slip-on
- » Delivers fit, comfort, flexibility, sensitivity and performance

ITEM #	ORDER #	DESCRIPTION	UOM
650-1001	G73510015	Small	100/Bx
650-1002	G73510025	Medium	100/Bx
650-1003	G73510035	Large	100/Bx
650-1004	G73510045	XLarge	100/Bx
650-1005	G73510055	XXLarge	100/Bx



6602

Thickster™ Latex Gloves

- » 14 mil latex
- » 12" length for added protection
- » Beaded cuff for easy donning
- » Textured for superior grip
- » Strong yet soft and flexible

ITEM #	ORDER #	DESCRIPTION	UOM
Powdered			
6602	G73566025	Medium	50/Bx
6603	G73566035	Large	50/Bx
6604	G73566045	XLarge	50/Bx
6605	G73566055	XXLarge	50/Bx
Powder-Free Exam Grade			
6602-20	G73502205	Medium	50/Bx
6603-20	G73503205	Large	50/Bx
6604-20	G73504205	XLarge	50/Bx
6605-20	G73505205	XXLarge	50/Bx



7700PFT

N-DEX® 7700PFT Nitrile Gloves

- » Latex-free, 100% nitrile and non-allergenic
- » Powder-free, bisque fingertips
- » Hides dirt and grime, rolled cuff prevents dirt from entering the glove
- » Second-skin feel significantly reduces hand fatigue
- » Accelerator-free
- » Low-modulus nitrile formulation reduces risk of allergies

ITEM #	ORDER #	DESCRIPTION	UOM
7700PFT-M	384177015	Medium	50/Bx
7700PFT-L	384177025	Large	50/Bx
7700PFT-XL	384102875	XLarge	50/Bx

WARNING: Cancer and Reproductive Harm - www.P65Warnings.ca.gov



8005

N-DEX® 8005 Nitrile Gloves

- » 8 mil latex-free, 100% nitrile
- » Lightly powdered, ambidextrous
- » Easy to tear away in case of emergency break
- » Rolled cuff prevents dirt from entering the glove
- » Easy to tear away in case of emergency break
- » Can easily be one-hand use

ITEM #	ORDER #	DESCRIPTION	UOM
8005-S	384180035	Small	50/Bx
8005-M	384180045	Medium	50/Bx
8005-L	384180055	Large	50/Bx
8005-XL	384180065	XLarge	50/Bx

WARNING: Cancer and Reproductive Harm - www.P65Warnings.ca.gov



Disposable



N-DEX® 7500PF Nitrile Gloves

- » 4 mil latex-free, 100% nitrile
- » Powder-free, ambidextrous
- » Priced competitively, economy grade
- » Reduces risk of allergies
- » Rolled cuff prevents dirt from entering the glove
- » Second-skin feel significantly reduces hand fatigue

ITEM #	ORDER #	DESCRIPTION	UOM
7500PF-S	384175015	Small	100/Bx
7500PF-M	384175025	Medium	100/Bx
7500PF-L	384175035	Large	100/Bx
7500PF-XL	384102765	XLarge	100/Bx
7500PF-2XL	384102775	XXLarge	100/Bx



7500PF



N-DEX® 6110PF Nitrile Gloves

- » 4 mil 100% nitrile with Eco Best Technology®
- » 100% biodegradable
- » Decreased risk of allergies
- » High performance of protection with second-skin fit and feel
- » Zero natural rubber latex proteins
- » 9.5" long with rolled cuff



6110PF

ITEM #	ORDER #	DESCRIPTION	UOM
6110PF-S	384102695	Small	100/Bx
6110PF-M	384102795	Medium	100/Bx
6110PF-L	384102835	Large	100/Bx
6110PF-XL	384103945	XLarge	100/Bx
6110PF-2XL	384104105	XXLarge	100/Bx

WARNING: Cancer and Reproductive Harm - www.P65Warnings.ca.gov



7005

N-DEX® 7005 Nitrile Gloves

- » 4 mil latex-free, 100% nitrile, ambidextrous
- » Superior durability and versatile performance
- » Protects hands from an array of chemical hazards
- » Rolled cuff prevents dirt from entering the glove
- » Low-modulus nitrile formulation reduces risk of allergies

ITEM #	ORDER #	DESCRIPTION	UOM
Powered			
7005-S	384191285	Small	100/Bx
7005-M	384191295	Medium	100/Bx
7005-L	384191305	Large	100/Bx
7005-XL	384191315	XLarge	100/Bx

ITEM #	ORDER #	DESCRIPTION	UOM
Powder-Free			
7005PF-S	384170125	Small	100/Bx
7005PF-M	384170135	Medium	100/Bx
7005PF-L	384170145	Large	100/Bx
7005PF-XL	384170155	XLarge	100/Bx

WARNING: Cancer and Reproductive Harm - www.P65Warnings.ca.gov



7705PFT

N-DEX® 7705PF Nitrile Gloves

- » Latex-free, 100% nitrile
- » Powder-free, ambidextrous
- » Chemical splash protection
- » Rolled cuff prevents dirt from entering the glove
- » Second-skin feel significantly reduces hand fatigue, bisque fingertips
- » Accelerator-free, low-modulus formulation

ITEM #	ORDER #	DESCRIPTION	UOM
7705PFT-L	384177085	Large	100/Bx
7705PFT-XL	384177095	XLarge	100/Bx



Drivers



1414

1414 Cowhide Gloves

- » Top grain pearl cowhide palm, bourbon Cowhide split leather back
- » Unlined, keystone thumb
- » Double stitching on forefinger provides extra strength

ITEM #	ORDER #	DESCRIPTION	UOM
1414S	C34102341	Small	PR
1414M	C34102301	Medium	PR
1414L	C34102291	Large	PR
1414XL	C34119121	XLarge	PR
14142X	C34102311	XXLarge	PR

WARNING: Cancer and Reproductive Harm - www.P65Warnings.ca.gov



1420

1420 Premium Cowhide Gloves

- » Premium quality pearl top grain Cowhide
- » Unlined, gunn cut
- » Straight thumb for best grip
- » Double stitching on forefinger provides extra strength
- » Leather rolled cuff hem

ITEM #	ORDER #	DESCRIPTION	UOM
1420M	C34102501	Medium	PR
1420L	C34102491	Large	PR
1420XL	C34119231	XLarge	PR

WARNING: Cancer and Reproductive Harm - www.P65Warnings.ca.gov



1415

1415 Premium Goatskin Gloves

- » Premium pearl top grain Goatskin
- » Excellent abrasion resistance and tensile strength
- » A keystone thumb, unlined

ITEM #	ORDER #	DESCRIPTION	UOM
1415M	C34102381	Medium	PR
1415L	C34102371	Large	PR
1415XL	C34119151	XLarge	PR

WARNING: Cancer and Reproductive Harm - www.P65Warnings.ca.gov



864

864 Deerskin Gloves

- » Top grain gold Deerskin
- » Incredible "all day" comfort
- » Double stitching on forefinger provides extra strength
- » A keystone thumb, unlined

ITEM #	ORDER #	DESCRIPTION	UOM
864M	C34117661	Medium	PR
864L	C34117651	Large	PR
864XL	C34121991	XLarge	PR

WARNING: Cancer and Reproductive Harm - www.P65Warnings.ca.gov



Drivers



1464L

1464 Cowhide with Kevlar® Gloves

- » Top grain Cowhide palm with added Cowhide split palm, thumb and index finger all sewn with Kevlar® thread for strength and heat resistance
- » Rollover index finger works great for spot welding
- » A wing thumb for natural feel
- » Cowhide split back with elastic for snug fit

ITEM #	ORDER #	DESCRIPTION	UOM
1464M	C34144641	Medium	PR
1464L	C34144651	Large	PR
1464XL	C34144661	XLarge	PR

⚠ WARNING: Cancer and Reproductive Harm - www.P65Warnings.ca.gov



1510

1510 Cowhide Gloves

- » Top grain A-grade cowhide leather, shirred back
- » Keystone thumb, gunn cut
- » Leather rolled hem prevents side seam blowout
- » Double sewn index finger seam

ITEM #	ORDER #	DESCRIPTION	UOM
1510/9	337915095	Size 9/Medium	12/Pk
1510/10	337915105	Size 10/Large	12/Pk
1510/11	337915115	Size 11/XLarge	12/Pk

⚠ WARNING: Cancer and Reproductive Harm - www.P65Warnings.ca.gov



3601

3601 Goatskin Gloves

- » Premium grade grain goatskin leather, unlined
- » Straight thumb
- » Shirred elastic back
- » Color-coded hem to identify size

ITEM #	ORDER #	DESCRIPTION	UOM
3601-L	331436035	Large	12/Pk
3601-XL	331409915	XLarge	12/Pk

⚠ WARNING: Cancer and Reproductive Harm - www.P65Warnings.ca.gov



3211

3211 Cowhide Gloves

- » Select grade grain cowhide leather, unlined
- » Keystone thumb
- » Shirred elastic back
- » Color-coded hem to identify size

ITEM #	ORDER #	DESCRIPTION	UOM
3211-L	331428985	Large	12/Pk
3211-XL	331428995	XLarge	12/Pk

⚠ WARNING: Cancer and Reproductive Harm - www.P65Warnings.ca.gov



Drivers



Y0135

WELLS LAMONT
Industrial

Y0135 Economy Cowhide Gloves

- » Economy grain cowhide leather
- » Straight thumb, gunn cut
- » Fabric bound hem

ITEM #	ORDER #	DESCRIPTION	UOM
Y0135M	416403535	Medium	12/Pk
Y0135L	416403525	Large	12/Pk



1178

WELLS LAMONT
Industrial

1178 Grips® Ball & Tape Gloves

- » Premium quality palomino grain cowhide with lanolin
- » Ball and tape adjustable wrist closure keeps dirt and debris out
- » Gunn cut, straight thumb, fabric bound hem

ITEM #	ORDER #	DESCRIPTION	UOM
1178M	416406465	Medium	12/Pk
1178L	416406455	Large	12/Pk
1178XL	416406485	XLarge	12/Pk
1178XXL	416406445	XXLarge	3/Pk

Electrical



6417

SAS SAFETY CORP.®

Electric Service Gloves, Class 0

- » Lightweight, rubber electric insulating glove, Class 0 Type 1
- » Meets ASTM D120 standard
- » 12" length rolled cuff
- » Protects up to AC/DC Volts 1000/1500

ITEM #	ORDER #	DESCRIPTION	UOM
6417	G73564171	Medium	PR
6418	G73501041	Large	PR
6419	G73564191	XLarge	PR
6420	G73501331	XXLarge	PR



6467

SAS SAFETY CORP.®

Leather Protector Gloves

- » Meets ASTM F696 standards
- » Wear over rubber electric insulating service gloves
- » Protects rubber insulating gloves from punctures and abrasion

ITEM #	ORDER #	DESCRIPTION	UOM
6467	G73501351	Medium	PR
6468	G73501321	Large	PR
6469	G73501301	XLarge	PR
6470	G73501311	XXLarge	PR



Electrical



6465



Glove Storage Bag

- » Made from heavy-duty polyester material
- » Hook and loop closure with heavy-duty belt loops
- » Extra storage pouch
- » Measures: 18.5"H x 8.625"W

ITEM #	ORDER #	DESCRIPTION	UOM
6465	G73501341	One Size Fits Most	EA



6477



Electric Service Glove Kits

Kit Includes:

- » 1 pair of electrical service gloves, Class 0 Type 1
- » Meets ASTM D120 standard
- » 1 pair of leather protective over gloves, Meets ASTM F696 standards
- » 1 protective glove bag

ITEM #	ORDER #	DESCRIPTION	UOM
6477	G73501361	Medium	KT
6478	G73564781	Large	KT
6479	G73501371	XLarge	KT
6480	G73501381	XXLarge	KT

General Purpose

Ansell

HyFlex® 11-800 Light Duty Gloves

- » Ansell's original foam nitrile coating channels oil away from glove surface for sure grip in light oil
- » Provides good grip in dry environments
- » Ergonomic form-fitting liner design molds naturally to the hand, minimizing fatigue
- » ANSI Level 1 cut resistance and Level 3 abrasion resistance



11-800

ITEM #	ORDER #	DESCRIPTION	UOM
11-800-6	220101225	Size 6	12/Pk
11-800-7	220118005	Size 7	12/Pk
11-800-8	220118015	Size 8	12/Pk
11-800-9	220118025	Size 9	12/Pk
11-800-10	220118035	Size 10	12/Pk

Ansell

HyFlex® 11-801 Light Duty Gloves

- » Patented Knitted Variable Stitch Design (KVSD) advanced technology for relaxed fit in high stress areas
- » Molds naturally to hand, helping prevent fatigue
- » Black foam nitrile coating/dark gray liner channels oil away from glove surface for sure grip in light oil applications
- » ANSI Level 1 cut resistance and Level 3 abrasion resistance



11-801

ITEM #	ORDER #	DESCRIPTION	UOM
11-801-7	220101275	Size 7	12/Pk
11-801-8	220101285	Size 8	12/Pk
11-801-9	220101295	Size 9	12/Pk
11-801-10	220101235	Size 10	12/Pk



General Purpose



11-600

Ansell

HyFlex® 11-600 Light Duty Gloves

- » Barehand-like dexterity for high tactility
- » Polyurethane palm coating offers maximum tactile sensitivity in the finger area for exceptional feel
- » Ultra-cool stretch nylon liner provides barehand dexterity
- » Breathable nylon liner increases worker acceptance and safety compliance

ITEM #	ORDER #	DESCRIPTION	UOM
Black			
11-600B-7	220100875	Size 7	12/Pk
11-600B-8	220100915	Size 8	12/Pk
11-600B-9	220100935	Size 9	12/Pk
11-600B-10	220100765	Size 10	12/Pk
White			
11-600W-7	220100865	Size 7	12/Pk
11-600W-8	220100895	Size 8	12/Pk
11-600W-9	220100925	Size 9	12/Pk
11-600W-10	220100755	Size 10	12/Pk

⚠ WARNING: Cancer and Reproductive Harm - www.P65Warnings.ca.gov



11-500

Ansell

HyFlex® 11-500 Ultra Light Duty Gloves

- » Stretch DuPont™ Kevlar® liner provides excellent cut resistance and comfortable fit
- » Product provides: ISO Cut Level B
- » Extended cuff offers extra cut protection around the wrist
- » Foam nitrile coating channels away oil from the surface of the gloves, providing a sure grip in light oil applications

ITEM #	ORDER #	DESCRIPTION	UOM
11-500-8	220100665	Size 8	12/Pk
11-500-9	220100675	Size 9	12/Pk
11-500-10	220100615	Size 10	12/Pk
11-500-11	220100625	Size 11	12/Pk

⚠ WARNING: Cancer and Reproductive Harm - www.P65Warnings.ca.gov

Ansell

PowerFlex® 80-100 Heavy Duty Gloves

- » Advanced ergonomic design features a soft, seamless poly/cotton knit liner for unbelievable comfort with superior wet and dry grip
- » Powerful combination of grip, abrasion and puncture resistance with fully-coated thumb provides added protection in this high-risk area
- » Uncoated back allows air to circulate, keeping hands cool and dry
- » ANSI Level 2 cut resistance and Level 4 abrasion resistance



80-100

ITEM #	ORDER #	DESCRIPTION	UOM
80-100-8	220111995	Size 8	12/Pk
80-100-9	220112005	Size 9	12/Pk
80-100-10	220111965	Size 10	12/Pk



Kleenguard* G29 Solvent Resistant Gloves

- » Neoprene blend construction designed for protection from solvents
- » Textured fingertips for wet or dry grip
- » Silicone-free, powder-free
- » 12" length, ambidextrous
- » 12 mil thick (at finger); 9 mil thick (at palm)

49824

ITEM #	ORDER #	DESCRIPTION	UOM
49824	154002135	Size 8/Medium	50/Bx
49825	154002125	Size 9/Large	50/Bx
49826	154002155	Size 10/XLarge	50/Bx
49827	154002115	Size 11/XXLarge	50/Bx



General Purpose



40226

Kleenguard* G40 Nitrile Coated Gloves

- » Foam nitrile coated glove provides excellent oil and industrial grease grip
- » Seamless knit nylon back for comfort
- » Silicone-free
- » High EN388 abrasion rating (EN388 ACTP score 4131)

ITEM #	ORDER #	DESCRIPTION	UOM
40226	154002265	Size 8/Medium	12/Pk
40227	154002275	Size 9/Large	12/Pk
40228	154002285	Size 10/XLarge	12/Pk



13838

Kleenguard* G40 Polyurethane Coated Gloves

- » Thin mil feel for tactile sensitivity
- » Seamless nylon knitted backing for breathability and comfort
- » Good tear and abrasion resistance for durability
- » Excellent dexterity - ideal for handling small components

ITEM #	ORDER #	DESCRIPTION	UOM
13838	154038005	Size 8/Medium	12/Pk
13839	154038015	Size 9/Large	12/Pk

WARNING: Cancer and Reproductive Harm - www.P65Warnings.ca.gov



85/3729

Worknit® 85/3729 Supported Nitrile Gloves

- » Supported nitrile gloves withstands abrasion better than most leather palm gloves
- » Flexible and launderable
- » Heavy-weight cotton lining gives extra cushion for comfort as well as wicks away perspiration
- » Gunn cut and wing thumb construction has a natural fit and feel

ITEM #	ORDER #	DESCRIPTION	UOM
85/3729L	347640405	Size Large	12/Pk
85/3729XL	347640425	Size X-Large	12/Pk

WARNING: Cancer and Reproductive Harm - www.P65Warnings.ca.gov



3382

M-Safe® Rubber-Coated Gloves

- » Wrinkled latex palm coated glove
- » Cotton/poly seamless knit
- » Provides excellent grip

ITEM #	ORDER #	DESCRIPTION	UOM
3382/9	337916995	Size 9/Large	12/Pk
3382/10	337917005	Size 10/XLarge	12/Pk
3382/11	337917015	Size 11/XXLarge	12/Pk



General Purpose



3229HVY

SuperDex™ Heavy Weight Gloves

- » Heavyweight foam nitrile palm on high visibility yellow nylon shell
- » 15-gauge liner for lightweight comfort
- » Pre-curved finger design to minimize hand fatigue
- » Ultra-cool, breathable coating keeps hands cool and dry
- » 100% launderable

ITEM #	ORDER #	DESCRIPTION	UOM
3229HVY/M	337916795	Medium	12/Pk
3229HVY/L	337916805	Large	12/Pk
3229HVY/XL	337916815	XLarge	12/Pk



3228

SuperDex™ Gloves

- » Micro foam nitrile palm coated glove on nylon shell
- » Ultra-cool, breathable coating keeps your hands cool and dry
- » Super dexterity for added grip
- » 15-gauge liner for lightweight comfort
- » Pre-curved finger design to minimize hand fatigue

ITEM #	ORDER #	DESCRIPTION	UOM
3228/M	337916595	Medium	12/Pk
3228/L	337916605	Large	12/Pk
3228/XL	337916615	XLarge	12/Pk



9680



FlexTuff® Latex-Dipped Gloves

- » 10-gauge natural cotton/polyester shell
- » Latex coated palm and fingertips
- » Cool and comfortable wear
- » Knit wrist

ITEM #	ORDER #	DESCRIPTION	UOM
Green, Economy			
9681-L	331418755	Large	12/Pk
Blue, Premium Textured			
9680-L	331496795	Large	12/Pk
9680-XL	331496805	XLarge	12/Pk
Gray, Value			
9688-L	331419025	Large	12/Pk
9688-XL	331419055	XLarge	12/Pk



8808



Dotted Cotton Canvas Gloves

- » 8 oz regular weight cotton canvas
- » Black PVC dots on palm and thumb
- » Clute pattern, knit wrist
- » Straight thumb

ITEM #	ORDER #	DESCRIPTION	UOM
8808	331414935	Large	12/Pk

WARNING: Cancer and Reproductive Harm - www.P65Warnings.ca.gov



General Purpose



Inspectors Gloves

- » Breathable fabric helps hands cool
- » Reversible, unhemmed
- » Comfortable and lightweight
- » 100% cotton



8600C

ITEM #	ORDER #	DESCRIPTION	UOM
8600C	331400675	Large	12/Pk



Brown Jersey Gloves

- » Breathable, absorbent
- » Cotton/polyester blend is excellent for laundering
- » Knit wrist
- » Clute pattern



7100

ITEM #	ORDER #	DESCRIPTION	UOM
7100	331414285	Large	12/Pk
7100P	331495325	Large	12/Pk



NorthFlex Red™ NF11 Lightweight Gloves

- » 15-gauge nylon glove with foam PVC coating on full palm and fingertips
- » No coating on back of hand for added ventilation
- » Seamless red nylon and black PVC



NF11

ITEM #	ORDER #	DESCRIPTION	UOM
NF11/L	347684895	Large	12/Pk
NF11/XL	347684905	XLarge	12/Pk



MCR Ninja® Lite Gloves

- » 18-gauge athletic grade nylon shell
- » Polyurethane coated palm and fingertips
- » ANSI Abrasion Level 4 and Tear Level 3
- » Feather-light second skin feeling



N9696

ITEM #	ORDER #	DESCRIPTION	UOM
N9696-L	331438365	Large	12/Pk

WARNING: Cancer and Reproductive Harm - www.P65Warnings.ca.gov



SHOWA® 306 Gloves

- » Revolutionary dual latex coating
- » Natural rubber coating offers superior grip
- » Full foam latex with extra coating on palm
- » Breathable 13-gauge liner
- » Seamless knit



306

ITEM #	ORDER #	DESCRIPTION	UOM
306M-07	384173075	Size 7	12/Pk
306L-08	384173085	Size 8	12/Pk
306XL-09	384173095	Size 9	12/Pk

WARNING: Cancer and Reproductive Harm - www.P65Warnings.ca.gov



MCR Ninja® BNF Gloves 18-Gauge

- » Ninja® “BNF”, Breathable Nitrile Foam
- » Seamless 18-gauge nylon/spandex red shell
- » Black nitrile foam palm and fingers
- » Great comfort, fit and dexterity
- » ANSI Abrasion Level 4 and Tear Level 2



N9697

ITEM #	ORDER #	DESCRIPTION	UOM
N96970-L	331469735	Large	12/Pk
N96970-XL	331469745	XLarge	12/Pk

WARNING: Cancer and Reproductive Harm - www.P65Warnings.ca.gov



General Purpose



SHOWA® 377 Gloves

- » 13-gauge seamless knit liner
- » Black absorbent foam nitrile palm coating ensures excellent grip even in oily applications
- » Fully dipped nitrile coating offers splash protection
- » Extra-long color-coded elastic wrist

ITEM #	ORDER #	DESCRIPTION	UOM
377M-07	384133015	Size 7	12/Pk
377L-08	384133025	Size 8	12/Pk
377XL-09	384133035	Size 9	12/Pk
377XXL-10	384113775	Size 10	12/Pk

WARNING: Cancer and Reproductive Harm - www.P65Warnings.ca.gov



SHOWA® 4500 Gloves

- » Flat dipped nitrile offers good dry grip and abrasion resistance
- » Seamless nylon liner, breathable ventilated back
- » Knit wrist
- » Machine washable

ITEM #	ORDER #	DESCRIPTION	UOM
4500-08	384101495	Size 8	12/Pk
4500-09	384101505	Size 9	12/Pk
4500-10	384101515	Size 10	12/Pk

WARNING: Cancer and Reproductive Harm - www.P65Warnings.ca.gov



SHOWA® ATLAS® 300 Gloves

- » Palm-dipped lightweight natural rubber coating
- » Cotton polyester liner
- » Rough textured grip
- » Elastic knit wrist cuff

ITEM #	ORDER #	DESCRIPTION	UOM
300M-08	384123065	Size 8	12/Pk
300L-09	384123075	Size 9	12/Pk
300XL-10	384123085	Size 10	12/Pk

WARNING: Cancer and Reproductive Harm - www.P65Warnings.ca.gov



WELLS LAMONT
Industrial

FlexTech™ Y9239 Hi-Viz Gloves

- » Machine knit cut resistant shell maximizes protection
- » Hi-Vis green lightweight seamless synthetic knit shell
- » Latex sandy gray palm provides outstanding grip
- » Knit wrist construction prevents dirt and debris from directly contacting the hand

ITEM #	ORDER #	DESCRIPTION	UOM
Y9239L	416490415	Large	12/Pk
Y9239XL	416490425	XLarge	12/Pk
With Brushed Fleece Lining for Warmth			
Y9239TL	416492465	Large	12/Pk
Y9239TXL	416492475	XLarge	12/Pk



WELLS LAMONT
Industrial

FlexTech™ Y9277 Gloves

- » Charcoal gray nylon with gray polyurethane palm coating which provides excellent grip and tactility
- » Silicone-free, gray fibers hide dirt and grime
- » Seamless design offers increased dexterity and flexibility for electronic assembly and component and small parts handling
- » ANSI Cut Level 1, A1

ITEM #	ORDER #	DESCRIPTION	UOM
Y9277L	416411765	Large	12/Pk
Y9277XL	416492775	XLarge	12/Pk

WARNING: Cancer and Reproductive Harm - www.P65Warnings.ca.gov



Heat Resistant



Honeywell
NORTH

51/7147

North Grip N® Hot Mill Gloves

- » Double face nitrile palm dot coating provides excellent grip and longer life
- » Provides protection against intermittent heat up to 400° F
- » 100% cotton knit design allows hand to breathe
- » Ambidextrous

ITEM #	ORDER #	DESCRIPTION	UOM
51/7147	347689705	One Size Fits Most	12/Pk



WELLS LAMONT
Industrial

636HRLFR

Jomac® Red Flame Retardant Gloves

- » Heat and flame retardant, protects up to 450° F
- » Red extra heavy weight terry cloth with 5" gauntlet for extra coverage
- » Fully lined with cotton for softness
- » Loop-out
- » Ambidextrous

ITEM #	ORDER #	DESCRIPTION	UOM
636HRLFR	416410615	XLarge	6/Pk



Ironclad
PERFORMANCE WEAR

HW4 Heatworx® Reinforced Up to 450°

- » Patent pending Hotshield® palm technology combines high dexterity with heat, cut, abrasion and shrink resistance
- » Oil repellency and washability
- » Kevlar® Inner Liner for heat & cut resistance
- » Kevlar® Blended Shell & Stitching for durability & protection in high heat environments

ITEM #	ORDER #	DESCRIPTION	UOM
HW4-03-M	C34804031	Medium	PR
HW4-04-L	C34801551	Large	PR
HW4-05-XL	C34802251	XLarge	PR
HW4-06-XXL	C34802391	XXLarge	PR



WELLS LAMONT
Industrial

636HRL

Jomac® Brown and White Flame Retardant Gloves

- » Heat protection up to 450° F
- » Brown and white extra heavy weight terry cloth
- » 5" gauntlet cuff for extra coverage
- » Ambidextrous
- » Loop-out

ITEM #	ORDER #	DESCRIPTION	UOM
636HRL	416411705	XLarge	6/Pk



Heat Resistant



WELLS LAMONT Industrial Jomac® Bakers Pads

- » Protects up to 460°F
- » Loop-out
- » Extra heavy weight: two layers of terry cloth

ITEM #	ORDER #	DESCRIPTION	UOM
With Hand Hole			
B-PAD	416400081	9.5" x 11"	EA
With Elastic Strap			
G-PAD	416401501	9" x 11.5"	EA



WELLS LAMONT Industrial Jomac® Extra Heavy Weight Terry Cloth Pads

- » Protects up to 325°F
- » Loop-out
- » Full thumb, open top
- » Fits easily over glove for added protection

ITEM #	ORDER #	DESCRIPTION	UOM
H-183	416400951	10" Length	EA



WELLS LAMONT Industrial Jomac® Medium Weight Terry Cloth Sleeves

- » Protects up to 250°F
- » Knit wrist
- » White cut & sewn sleeve, loop-out
- » Elastic top secures sleeve to upper arm

ITEM #	ORDER #	DESCRIPTION	UOM
S-25HR	416402371	16" Length	EA

WELLS LAMONT Industrial Jomac® Standard Weight Gloves

- » Protects up to 300°F
- » 60% cotton, 40% polyester white loop-out terry cloth
- » Knit wrist
- » Ambidextrous



ITEM #	ORDER #	DESCRIPTION	UOM
1666	416416665	Large	12/Pk



WELLS LAMONT Industrial Jomac® KELKLAVE Autoclave Gloves

- » Protects up to 250°F
- » White loop-out terry cloth
- » 11" gauntlet cuff
- » Clute cut

ITEM #	ORDER #	DESCRIPTION	UOM
422-11	416410125	Large	12/Pk

WELLS LAMONT Industrial Jomac® Heavy Weight Cut & Sewn Gloves

- » Protects up to 325°F
- » Knit wrist
- » 100% white cotton loop-out terry cloth
- » Ambidextrous



ITEM #	ORDER #	DESCRIPTION	UOM
765	416407655	Medium	6/Pk
766	416410785	Large	6/Pk



Leather and Work Gloves



1500YPP

1500YPP Brown Side Split Cowhide Gloves

- » Rugged, bourbon brown side split Cowhide 3-piece palm
- » Yellow canvas back
- » Gunn cut with 2.5" rubberized safety cuff
- » Features lock stitching for added strength
- » Cotton lined palm with unlined back

ITEM #	ORDER #	DESCRIPTION	UOM
1500YPP	C34103511	Large	PR

⚠️ WARNING: Cancer and Reproductive Harm - www.P65Warnings.ca.gov



1528

1528 Full Leather Back Gloves

- » Rugged, select shoulder split Cowhide palm
- » Full leather back
- » A gunn cut with 4.5" rubberized safety cuff
- » Features lock stitching for added strength

ITEM #	ORDER #	DESCRIPTION	UOM
1528	C34103981	Large	PR

⚠️ WARNING: Cancer and Reproductive Harm - www.P65Warnings.ca.gov



1300

1300 Leather Palm Gloves

- » B Grade select shoulder leather
- » Blue fabric with red/black stripes
- » 2 1/2" Rubberized safety cuff

ITEM #	ORDER #	DESCRIPTION	UOM
1300-L	331406365	Large	12/Pk
1300-XL	331437071	X-Large	12/Pk

⚠️ WARNING: Cancer and Reproductive Harm - www.P65Warnings.ca.gov



1200

1211 Leather Palm Gloves

- » C Grade cowhide shoulder leather
- » Double palm
- » Wing thumb
- » 2.5" Rubberized safety cuff
- » Additional palm layer adds abrasion and wear protection

ITEM #	ORDER #	DESCRIPTION	UOM
1211XL	331406095	X-Large, Double palm	12/Pk
1211J	331412115	Large, Jointed double palm	12/Pk

⚠️ WARNING: Cancer and Reproductive Harm - www.P65Warnings.ca.gov



Leather and Work Gloves



1700-L



Big Jake® Leather Palm Gloves

- » The ultimate in leather hand protection
- » Select premium A+ side split cow leather and sewn with DuPont™ Kevlar®
- » 8 oz jersey palm lining, cotton canvas back and rubberized safety cuff keep your hands cool, comfortable and safe
- » Full feature gunn pattern

ITEM #	ORDER #	DESCRIPTION	UOM
1700-L	331407215	Large	12/Pk

⚠ WARNING: Cancer and Reproductive Harm - www.P65Warnings.ca.gov



1935

1936



Mustang Leather Palm Gloves

- » Premium grain cowhide leather palm
- » Rubberized cuff
- » Wing thumb
- » Shirred elastic back

ITEM #	ORDER #	DESCRIPTION	UOM
2.5" Safety Cuff			
1935-L	331408025	Large	12/Pk
1935-XL	331408045	XLarge	12/Pk
4.5" Gauntlet Cuff			
1936-L	331408055	Large	12/Pk
1936-XL	331408075	XLarge	12/Pk

⚠ WARNING: Cancer and Reproductive Harm - www.P65Warnings.ca.gov



224



White Mule® Leather Palm Gloves

- » Premium pearl gray side split cowhide
- » Full leather first finger, thumb and finger tips
- » Fabric back with leather knuckle strap
- » Safety cuff
- » Gunn cut and straight thumb

ITEM #	ORDER #	DESCRIPTION	UOM
2.5" Cuff			
224M	416409475	Medium	12/Pk
224L	416409465	Large	12/Pk
5" Cuff			
229L	416409505	Large	12/Pk



Y0107 Grain Goatskin Gloves

- » Quality goatskin with natural lanolin for softness and wear
- » Goatskin has a higher natural tensile strength despite abrasion
- » Gunn cut and keystone thumb for added dexterity and flexibility
- » Fabric bound hem



Y0107S

ITEM #	ORDER #	DESCRIPTION	UOM
Y0107S	416403375	Small	12/Pk
Y0107M	416403365	Medium	12/Pk
Y0107L	416403345	Large	12/Pk
Y0107XL	416411505	XLarge	12/Pk



Trade and Utility



Squids® Grabbers

- » Grabber clip mounts to d-rings, clothing, etc.
- » Durable, ultra-resilient acetal copolymer
- » Dielectric/non-conductive material
- » Grabbers disconnect and can be used independently
- » Breakaway feature



19112



19117



19118



19119

ITEM #	ORDER #	DESCRIPTION	UOM
19112	332104511	Black	EA
19117	332104521	Blue	EA
19118	332104531	Orange	EA
19119	332104541	Lime	EA



GUG



GUG General Utility™ Gloves

- » Synthetic leather reinforcements in critical areas for maximum durability
- » Patented palm design for excellent dexterity and durability
- » Terry cloth sweat wipe
- » Hybrid cuff system for secure fit with built in quick release safety feature

ITEM #	ORDER #	DESCRIPTION	UOM
GUG-03-M	C34801351	Medium	PR
GUG-04-L	C34801361	Large	PR
GUG-05-XL	C34801371	XLarge	PR



HUG



HUG Heavy Utility™ Gloves

- » Duraclad® reinforcements are 8X more durable than normal synthetic leather
- » Hybrid cuff system for secure fit with built in quick release safety feature
- » Patented palm design to get your glove in the proper position faster
- » Terry cloth sweat wipe
- » TPR cuff puller with hook and loop closure

ITEM #	ORDER #	DESCRIPTION	UOM
HUG-03-M	C34801451	Medium	PR
HUG-04-L	C34801461	Large	PR
HUG-05-XL	C34801471	XLarge	PR



BHG



BHG Box Handler® Gloves

- » Diamondclad® silicone-fused palm for ultimate grip
- » Duraclad® reinforcements are 8X more durable than normal synthetic leather
- » Terry cloth sweat wipe
- » TPR cuff puller with hook and loop closure
- » Hybrid cuff system for secure fit with built in quick release safety feature
- » Neoprene knuckles offers protection and breathability

ITEM #	ORDER #	DESCRIPTION	UOM
BHG-03-M	C34800741	Medium	PR
BHG-04-L	C34800751	Large	PR
BHG-05-XL	C34800761	XLarge	PR



Trade and Utility



Industrial Athlete Hi-Viz Impact Gloves

- » Back of hand TPR impact protection
- » High visibility color for safety and visibility
- » Terry cloth sweat wipe
- » TPR cuff puller with hook and loop closure
- » Vibration-reducing reinforced palm



EXO-HZI

ITEM #	ORDER #	DESCRIPTION	UOM
EXO-HZI-03-M	C34802831	Medium	PR
EXO-HZI-04-L	C34802841	Large	PR
EXO-HZI-05-XL	C34802851	XLarge	PR
EXO-HZI-06-XXL	C34802861	XXLarge	PR



Motor Pro Leather Palm Work Gloves

- » Goat leather palm
- » Suede cuff puller
- » Terry cloth sweat wipe
- » Neoprene knuckle impact protection
- » TPR hook and loop closure



EXO2-MPLW

ITEM #	ORDER #	DESCRIPTION	UOM
EXO2-MPLW-03-M	C34803341	Medium	PR
EXO2-MPLW-04-L	C34803351	Large	PR
EXO2-MPLW-05-XL	C34803361	XLarge	PR
EXO2-MPLW-06-XXL	C34803371	XXLarge	PR



Industrial Impact Cotton Corded Palm Gloves

- » Cotton corded palm provides low cost all-around grip with Duraclad® index/saddle reinforcements
- » IVE™ patent pending optical technology with reflective fabric for nighttime visibility
- » Proven impact protection on fingers, thumb, knuckles and metacarpal bones
- » Airprene cuff offers a snug fit, easy to remove, breathable



INDI-CCP

ITEM #	ORDER #	DESCRIPTION	UOM
INDI-CCP-03-M	C34803241	Medium	PR
INDI-CCP-04-L	C34802341	Large	PR
INDI-CCP-05-XL	C34802401	XLarge	PR
INDI-CCP-06-XXL	C34802411	XXLarge	PR



Project Lover Project Impact Gloves

- » Protection for you projects
- » Back of hand TPR impact protection
- » TPR cuff puller with hook and loop closure
- » Terry cloth sweat wipe
- » Vibration-reducing reinforced palm



EXO-PIG

ITEM #	ORDER #	DESCRIPTION	UOM
EXO-PIG-03-M	C34803391	Medium	PR
EXO-PIG-04-L	C34803401	Large	PR
EXO-PIG-05-XL	C34803411	XLarge	PR
EXO-PIG-06-XXL	C34803421	XXLarge	PR

Trade and Utility



Modern Leather Reinforced Gloves

- » Machine washable goatskin leather palm reinforcements for durability
- » Terry cloth sweat wipe
- » TPR cuff puller with hook and loop closure
- » EXO embossed palm
- » Neoprene knuckle impact protection



EXO-MLR

ITEM #	ORDER #	DESCRIPTION	UOM
EXO-MLR-03-M	C34802981	Medium	PR
EXO-MLR-04-L	C34802991	Large	PR
EXO-MLR-05-XL	C34803001	XLarge	PR
EXO-MLR-06-XXL	C34803011	XXLarge	PR



KONG® Original Gloves

- » The original oil and gas industry glove co-developed by the Oil & Gas Industry's Safety Committee
- » KONG® metacarpal protection - 80% impact absorption
- » KONG® knuckle protection - 90% impact absorption
- » Exclusive palm material - 25% more abrasion resistant than normal synthetic leather
- » KONG® patent pending finger protection - 76.4% impact absorption offers sidewall and complete fingertip protection



SDX2

ITEM #	ORDER #	DESCRIPTION	UOM
SDX2-02-S	C34802631	Small	PR
SDX2-03-M	C34802641	Medium	PR
SDX2-04-L	C34802651	Large	PR
SDX2-05-XL	C34802661	XLarge	PR



1470 TrueFit™ Goatskin Gloves

- » Top grain Goatskin construction
- » Leather and spandex design
- » Rough side out double palm
- » Reinforced thumb
- » Elastic cuff with hook and loop closure
- » Top grain leather side bolsters
- » All finger tips covered in smooth surface leather



1470

ITEM #	ORDER #	DESCRIPTION	UOM
1470S	C34103191	Small	PR
1470M	C34103181	Medium	PR
1470L	C34103171	Large	PR
1470XL	C34103201	XLarge	PR
14702X	C34103211	XXLarge	PR

⚠ WARNING: Cancer and Reproductive Harm - www.P65Warnings.ca.gov



1475 TrueFit™ Cowhide Gloves

- » Top grain Cowhide construction
- » Leather and spandex design
- » Rough side out double palm
- » Reinforced thumb
- » Elastic cuff with hook and loop closure
- » Top grain leather side bolsters
- » All finger tips covered in smooth surface leather



1475

ITEM #	ORDER #	DESCRIPTION	UOM
1475M	C34103241	Medium	PR
1475L	C34103231	Large	PR
1475XL	C34119461	XLarge	PR

⚠ WARNING: Cancer and Reproductive Harm - www.P65Warnings.ca.gov



Trade and Utility



1485

1485 TrueFit™ Pigskin Gloves

- » Moisture resistant top grain Pigskin with Thinsulate™ lining
- » Spandex back
- » Rough side out double palm
- » Reinforced thumb
- » Elastic cuff with hook and loop closure
- » Top grain leather side bolsters
- » All finger tips covered in smooth surface leather

ITEM #	ORDER #	DESCRIPTION	UOM
1485M	C34103321	Medium	PR
1485L	C34103311	Large	PR
1485XL	C34119511	XLarge	PR
14852X	C34103331	XXLarge	PR

WARNING: Cancer and Reproductive Harm - www.P65Warnings.ca.gov



958

958 13-Gauge Blend Gloves

- » 13-gauge blend: nylon, Kevlar®, steel wire, cotton and spandex shell
- » Polyurethane coating
- » Breathable comfort, best dexterity
- » Touchscreen compatible
- » ANSI ISEA Cut Level A7, CE EN388 Level 5

ITEM #	ORDER #	DESCRIPTION	UOM
958L	C34100271	Large	PR
958XL	C34100251	XLarge	PR



1490

1490 TrueFit™ Ultra Goatskin Gloves

- » Top grain gold/pearl Goatskin double palm and thumb
- » Breathable, double reinforced finger tips
- » Clute cut design
- » Longer elastic cuff with hook and loop closure
- » Top grain leather side bolsters
- » Nylon spandex back

ITEM #	ORDER #	DESCRIPTION	UOM
1490M	C34103351	Medium	PR
1490L	C34103341	Large	PR
1490XL	C34103371	XLarge	PR

WARNING: Cancer and Reproductive Harm - www.P65Warnings.ca.gov



21242HO

Knucklehead X10™ Unlined Hi-Viz Gloves

- » Armor Skin™ synthetic leather palm with PVC palm patch
- » Hi-Viz knit back with full finger and back of hand TPR impact protection
- » Pre-curved finger
- » Elastic cuff closure
- » 12 per pack

ITEM #	ORDER #	DESCRIPTION	UOM
21242HO/9	337915395	Size 9/Medium	12/PK
21242HO/10	337915405	Size 10/Large	12/PK
21242HO/11	337915415	Size 11/XLarge	12/PK



Trade and Utility



2136HY



Armor Skin™ Hi-Viz Gloves

- » Armor Skin™ synthetic leather palm
- » Hi-Viz knit back with neoprene knuckle
- » Pre-curved finger
- » Slip on wrist

ITEM #	ORDER #	DESCRIPTION	UOM
2136HY/9	337915595	Size 9/Medium	12/Pk
2136HY/10	337915605	Size 10/Large	12/Pk
2136HY/11	337915615	Size 11/XLarge	12/Pk



2137HO



Armor Skin™ Mechanics Gloves

- » Armor Skin™ synthetic leather palm
- » Neoprene absorbing knuckle
- » Breathable knit back
- » Pre-curved finger
- » Velcro closure

ITEM #	ORDER #	DESCRIPTION	UOM
Hi-Viz Orange			
2137HO/9	337915895	Size 9/Medium	12/Pk
2137HO/10	337915905	Size 10/Large	12/Pk
2137HO/11	337915915	Size 11/XLarge	12/Pk



PD2903



Predator™ Cow Grain Leather Multi-Task Gloves

- » D30® impact and vibration reducing palm padding
- » Brown 2-way spandex back with full patent pending tire tread TPR
- » Reinforced thumb crotch
- » Hook and loop closure with ID panel
- » Synthetic fourchettes for breathability and comfort
- » ANSI Cut Level A2

ITEM #	ORDER #	DESCRIPTION	UOM
PD2903M	331487351	Medium	PR
PD2903L	331487361	Large	PR
PD2903XL	331487371	XLarge	PR

WARNING: Cancer and Reproductive Harm - www.P65Warnings.ca.gov



PD2904



Predator™ Multi-Task Gloves

- » Synthetic leather palm
- » Polymer pads on fingertips, palm and thumb crotch
- » Black 2-way spandex back with full patent pending tire tread TPR
- » Hook and loop closure with ID panel
- » Synthetic fourchettes for breathability and comfort

ITEM #	ORDER #	DESCRIPTION	UOM
PD2904M	331487401	Medium	PR
PD2904L	331487411	Large	PR
PD2904XL	331487421	XLarge	PR

WARNING: Cancer and Reproductive Harm - www.P65Warnings.ca.gov



Trade and Utility



MG-02



MG-03



MG-05



The Original Gloves

- » Breathable TrekDry® material keeps your hands cool and comfortable
- » Thermoplastic Rubber (TPR) closure provides a secure fit
- » Industrial grade hook and loop
- » Double-stitched index finger construction
- » Seamless synthetic leather palm
- » Machine washable

ITEM #	ORDER #	DESCRIPTION	UOM
Red			
MG-02-009	C24500531	Medium	PR
MG-02-010	C24500541	Large	PR
MG-02-011	C24500551	XLarge	PR
Blue			
MG-03-009	C24500591	Medium	PR
MG-03-010	C24500601	Large	PR
MG-03-011	C24500611	XLarge	PR
Black			
MG-05-009	C24500681	Medium	PR
MG-05-010	C24500691	Large	PR



Utility Work Gloves

- » Thermoplastic Rubber (TPR) top closure provides a secure fit
- » Breathable TrekDry® material keeps your hands cool and comfortable
- » Reinforced thumb and index finger provide added durability
- » Two-piece palm eliminates material bunching
- » Durable synthetic leather palm
- » Machine washable



H15-05

ITEM #	ORDER #	DESCRIPTION	UOM
H15-05-009	C2451111	Medium	PR
H15-05-010	C24502431	Large	PR
H15-05-011	C24502441	XLarge	PR



The Original® CR5A5 Gloves

- » Hi-Viz breathable TrekDry® material keeps your hands cool and comfortable
- » Reflective ink provides eye-catching luminance in low-light environments
- » Internal layer of Armortex® delivers CE level 5 and ANSI A5 cut resistance
- » Touchscreen capable palm and fingers
- » Thermoplastic Rubber (TPR) closure with hook and loop
- » Machine washable



SMG-C91

ITEM #	ORDER #	DESCRIPTION	UOM
SMG-C91-008	C24511081	Small	PR
SMG-C91-009	C24561691	Medium	PR
SMG-C91-010	C24561701	Large	PR
SMG-C91-011	C24561711	XLarge	PR
SMG-C91-012	C24511131	XXLarge	PR

Trade and Utility



FastFit® Gloves

- » Breathable TrekDry® material keeps your hands cool and comfortable
- » Two-piece palm design with reinforced thumb and index finger
- » Stretch-elastic cuff
- » Pinched fingertip construction
- » High-dexterity touchscreen capable 0.6 mm synthetic leather
- » Machine washable



MFF-03

ITEM #	ORDER #	DESCRIPTION	UOM
Red			
MFF-02-009	C24500251	Medium	PR
MFF-02-010	C24500261	Large	PR
MFF-02-011	C24500271	XLarge	PR
Blue			
MFF-03-009	C24500301	Medium	PR
MFF-03-010	C24500311	Large	PR
MFF-03-011	C24500321	XLarge	PR
Black/Gray			
MFF-05-009	C24500351	Medium	PR
MFF-05-010	C24500361	Large	PR
MFF-05-011	C24500371	XLarge	PR



DuraHide® Leather Original® Gloves

- » Flexible Thermoplastic Rubber (TPR) closure provides a secure wrist fit
- » Breathable TrekDry® material keeps your hands cool and comfortable
- » Double-stitched index finger and thumb
- » Pinched fingertip construction
- » DuraHide® leather fourchettes and palm
- » Machine washable



LMG-75

ITEM #	ORDER #	DESCRIPTION	UOM
LMG-75-008	C24502821	Small	PR
LMG-75-009	C24502831	Medium	PR
LMG-75-010	C24502841	Large	PR
LMG-75-011	C24502851	XLarge	PR
LMG-75-012	C24502861	XXLarge	PR



Hi-Viz FastFit® Gloves

- » Hi-Viz breathable TrekDry® material keeps your hands cool and comfortable
- » Reflective ink provides eye-catching luminance
- » Two-piece palm design with reinforced thumb and index finger
- » Stretch-elastic cuff
- » Pinched fingertip construction
- » High-dexterity touchscreen capable 0.6 mm synthetic leather
- » Machine washable



SFF-91

ITEM #	ORDER #	DESCRIPTION	UOM
SFF-91-009	C24511091	Medium	PR
SFF-91-010	C24511101	Large	PR
SFF-91-011	C24511111	XLarge	PR



DuraHide® Leather M-Pact® Framer Gloves

- » Flexible Thermoplastic Rubber (TPR) closure provides a secure wrist fit
- » Breathable TrekDry® material keeps your hands cool and comfortable
- » Patented Impact Guard™ protects the first knuckle with EVA foam padding
- » (TPR) knuckle guard, full-length fingertip protection with fingerless design
- » DuraHide® leather palm with D30® padding
- » Machine washable



LFR-75

ITEM #	ORDER #	DESCRIPTION	UOM
LFR-75-008	C24502871	Small	PR
LFR-75-009	C24502881	Medium	PR
LFR-75-010	C24502891	Large	PR
LFR-75-011	C24502901	XLarge	PR
LFR-75-012	C24502911	XXLarge	PR



Trade and Utility



M-Pact® 2 Gloves

- » Accordion knuckle guard with high density EVA foam padding
- » Extended neoprene cuff with Thermoplastic Rubber (TPR) closure with hook and loop
- » Armortex® fingertips, (TPR) finger guards and metacarpal protection
- » D30® and high-density EVA foam palm padding
- » Breathable TrekDry® material keeps your hands cool and comfortable
- » Machine washable



MP2-05

ITEM #	ORDER #	DESCRIPTION	UOM
MP2-05-009	C24501701	Medium	PR
MP2-05-010	C24501711	Large	PR
MP2-05-011	C24501721	XLarge	PR



M-Pact® Gloves

- » Patented Impact Guard™ protects the first knuckle with EVA foam padding
- » Thermoplastic Rubber (TPR) closure provides a secure fit to your wrist
- » TPR knuckle guards and full-length fingertip protection
- » Breathable TrekDry® material keeps your hands cool and comfortable
- » Synthetic leather palm with D30® padding and Armortex® palm reinforcement panel
- » Machine washable



MPT-58

ITEM #	ORDER #	DESCRIPTION	UOM
MPT-58-009	C24558091	Large	PR
MPT-58-010	C24558101	XLarge	PR
MPT-58-011	C24558111	XXLarge	PR



MechPro™ 7701 Gloves

- » Heavy duty ribbed knit fabric
- » Synthetic leather palm and fingertips
- » Reinforced fingertips with improved pinched fingertip design
- » Gusseted finger crotch and perforated finger fourchettes
- » Double stitched in high wear areas: fingertips, index finger and palm
- » Elastic cuff with Feeltite™ hook and loop adjustable wrist closure



7701

ITEM #	ORDER #	DESCRIPTION	UOM
7701L	416410845	Large	3/Pk
7701XL	416410875	XLarge	3/Pk



MechPro™ Plus Gloves

- » MechPro™ 7701 shell with extra padding in the palm area helps to minimize shock
- » Improved pinched fingertip design and gusseted finger crotch for comfort
- » Hook and loop adjustable wrist closure



Y7711

ITEM #	ORDER #	DESCRIPTION	UOM
Y7711M	416405675	Medium, 12/Pk	12/Pk
Y7711L	416405665	Large, 12/Pk	12/Pk

Helmets & Filters

3M

3M™ Speedglas™ Welding Helmet 100 with Auto-Darkening Filter

- » Shade range: variable 8 - 12
- » Viewing area: 1.73" x 3.66" (44 x 93 mm)
- » Sensitivity: 3 level (TIG>10A & MIG/MAG, Stick)
- » User type: part-time welder, student
- » ANSI Z87.1-2010

ITEM #	ORDER #	DESCRIPTION	UOM
07-0012-31BL	665521121	Black	EA



07-0012-31BL



06-0100-20QR

3M

3M™ Speedglas™ 9100QR Welding Helmet with Auto-Darkening Filter and Hard Hat

- » Shade range: variable 5, 8 - 13
- » Sensitivity: 5 level (TIG>1A & MIG/MAG, Stick)
- » Side windows with shade 5 side filters
- » User type: professional, specialty

ITEM #	ORDER #	DESCRIPTION	UOM
06-0100-20QR	665545831	Auto-Darkening Filter 9100X with Viewing Area - 2.1" x 4.2" (54 x 107 mm)	EA
06-0100-30QR	665534671	Auto-Darkening Filter 9100XX with Viewing Area - 2.8" x 4.2" (73 x 107 mm)	EA

3M

3M™ Speedglas™ Welding Helmet 9000 and 9002NC

- » Precision optics, which provide a view that appears lighter, brighter and more realistic, giving you better control of the weld puddle
- » A more comfortable suspension for longer wear time
- » Lighter weight, better for longer wearing, just 17 oz
- » Slim fit, better for tight spots

Helmet 9002NC

- ADF shade range: variable 8 - 12 ADF
- Sensitivity: 4 level (TIG>10A & MIG/MAG, stick)
- Viewing area: (H x W) 2.13" x 4.09"
- ANSI Z87.1-2010



04-0100-20NC

ITEM #	ORDER #	DESCRIPTION	UOM
04-0112-00NC	665541451	Welding Helmet 9000 without Welding Filter	EA
04-0000-21NC	665541461	Welding Filter for use with Helmet 9000	EA
04-0212-02NC	665541471	Faceshield Front Panel for Welding Helmet 9000	EA
04-0100-20NC	665541481	Welding Helmet 9002NC with ADF	EA

WARNING

These welding safety products must be used only by qualified persons trained in their use and maintenance and only in strict accordance with and adherence to the detailed instruction and precautionary statements provided in the instruction manual which accompanies each product. **Failure to comply with these instructions could result in sickness, serious bodily injury or loss of life.**

For proper use of these products read *User Instructions* and Warnings on the package. Any questions concerning proper use should be directed to your supervisor, on-site training specialist, industrial hygienist or 3M Occupational Health and Environmental Safety Division (PSD) Technical Service in the U.S.A. at 1-800-243-4630. In Canada, call Technical Service at 1-800-267-4414.



Helmets & Filters



3M™ Speedglas™ 9100 Welding Helmet with Auto-Darkening Filter

- » Shade range: variable 5, 8 - 13
- » Sensitivity: 5 level (TIG>1A & MIG/MAG, Stick)
- » Side windows with shade 5 side filters
- » User type: professional, specialty



06-0000-30i-KIT



06-0100-30iSW

ITEM #	ORDER #	DESCRIPTION	UOM
06-0100-30iSW	665521091	Helmet with Auto-Darkening Filter 9100XXi	EA
06-0000-30i	665521051	Auto-Darkening Filter 9100XXi	EA
06-0000-30i-KIT	665534681	Kit Includes Auto-Darkening Filter 9100XXi and Front Panel	EA

WARNING

These welding safety products must be used only by qualified persons trained in their use and maintenance and only in strict accordance with and adherence to the detailed instruction and precautionary statements provided in the instruction manual which accompanies each product. **Failure to comply with these instructions could result in sickness, serious bodily injury or loss of life.**

For proper use of these products read *User Instructions* and Warnings on the package. Any questions concerning proper use should be directed to your supervisor, on-site training specialist, industrial hygienist or 3M Occupational Health and Environmental Safety Division (PSD) Technical Service in the U.S.A. at 1-800-243-4630. In Canada, call Technical Service at 1-800-267-4414.



Jackson Safety* HSL100 NexGen Digital Variable ADF Welding Helmet

- » Variable shade 9 - 13
- » Viewing area: 3.80" x 2.35"
- » Easy to use digital controls
- » Sensitivity and delay adjustments for different tasks and durations



16622



46148

ITEM #	ORDER #	DESCRIPTION	UOM
46148	154003961	Black Helmet	EA
16622	C24118191	Digital Auto-Darkening Cartridge	EA



Jackson Safety* W20 Fiber Shell Welding Helmets

- » Lightweight vulcanized fiber shell
- » Made of 10% recycled fiber content
- » Not suited for damp environments or overhead welding
- » Fixed front with aluminum frame filter plate holder
- » Meets ANSI Z87.1-2010



14528

ITEM #	ORDER #	DESCRIPTION	UOM
14527	C24125321	411P Viewing Field 2" x 4.25", Fixed Front with Aluminum Frame Filter Plate Holder	EA
14528	C24113691	430P Viewing Field 2" x 4.25", Lift Front Filter	EA
14529	C24113931	451P Viewing Field 4.5" x 4.25"	EA
14532	C24114101	490P Viewing Field 2" x 4.25", Quick-Slide Filter Plate Holder	EA



Helmets & Filters



14531



Jackson Safety* W20 860 Lift Front Leather Welding Helmet

- » Viewing field: 2" x 4.25"
- » Shell material: leather
- » ANSI Z87.1 and CSA Compliant

ITEM #	ORDER #	DESCRIPTION	UOM
14531	C24114391	Red Leather	EA



14535



Jackson Safety* W10 Series Passive Welding Helmets

- » Lightweight, pliable shell
- » Equipped with a shade 10 polycarbonate filter
- » ANSI Z987.1 and CSA Compliant

ITEM #	ORDER #	DESCRIPTION	UOM
14534	C24114461	930P, Lift Front, Viewing Area 2" x 4.25"	EA
14535	C24114471	951P, Viewing Area 4.5" x 5.25"	EA



14975



Jackson Safety* W10 HSL 100 Passive Welding Helmets

- » A shade 10 polycarbonate filter
- » For students, hobbyist and inspectors
- » ANSI Z87.1, CSA Compliant and CE Marked

ITEM #	ORDER #	DESCRIPTION	UOM
14975	C24116621	Black, Viewing Field 4.5" x 5.25"	EA
14978	C24116661	Black with 187 Blades	EA
14982	C24116711	HSL 2 Black, Viewing Field 2" x 4.25", Lift Front	EA
15134	C2419459	Black, Viewing Field 4.5" x 5.25" (Bulk)	10/Cs



21931



Jackson Safety* W40 NITRO* Welding Helmet with NITRO* Auto-Darkening Filter

- » Variable shade 9 - 13
- » Viewing area: 3.80" x 1.60"
- » For the everyday welder
- » ANSI Z87.1, CSA Compliant

ITEM #	ORDER #	DESCRIPTION	UOM
21931	C24182301	Blue	EA
36633	C2416633	Black	2/Cs



Helmets & Filters



46131



Jackson Safety* INSIGHT Digital Variable ADF Welding Helmet

- » Variable shade: 9 - 13
- » Viewing area: 3.93" x 2.36"
- » 4 independent auto dimming sensors
- » ANSI Z87.1-2010 and CSA Z94.3 Compliant
- » Digital controls

ITEM #	ORDER #	DESCRIPTION	UOM
46129	154003861	HSL 100 Welding Helmet with Insight* Variable ADF – Black	EA
46131	154003991	HLX 100 Welding Helmet with Insight* Variable ADF – Black	EA



23282



Jackson Safety* ELEMENT* Variable ADF Welding Helmet

- » Variable shade: 9 - 13
- » Viewing area: 3.78" x 1.65"
- » Sensitivity and delay adjustments
- » Two independent sensors
- » Solar-powered
- » ANSI Z87.1-2010 and CSA Z94.3 Compliant

ITEM #	ORDER #	DESCRIPTION	UOM
23282	C24124631	Variable ADF, Viewing Field 3.78" x 1.65"	EA



46157



Jackson Safety* BH3* Helmet with BALDER* Technology

- » Variable shade (9 - 13), adjustable sensitivity and opening time delays
- » Auto-On ADF is always ready to weld
- » Meets ANSI Z87.1 High Impact 2010 standard, CE Certified, DIN Plus Certified

ITEM #	ORDER #	DESCRIPTION	UOM
46157	15400564	Black/Orange	EA



46163



46162



Jackson Safety* TrueSight II Digital Variable ADF Welding Helmet with Balder Technology

- » Variable shade: 5 - 8 and 9 - 13
- » Viewing area: 3.25" x 4.00"
- » 4 sensors and auto off
- » Delay and sensitivity adjustments
- » ANSI Z87.1-2010 and CSA Z94.3 Compliant
- » DIN Plus Certified



46158

ITEM #	ORDER #	DESCRIPTION	UOM
46163	15400563	Arc Angel	EA
46162	15400561	Serpent	EA
46158	15400559	TrueSight II Cartridge	EA
46159	15400560	Black	EA



Helmets & Filters



Jackson Safety* AIRMAX ELITE* Powered Air Purifying Respirator with BH3* Air Headpiece

- » Variable ADF with grind mode
- » Adjustable shades 6 - 8 (torch) and 9 - 13 via external knob
- » Viewing area of 3.78" x 2.70"
- » Audible and vibrating alarms signal welder when need for new filter or battery change
- » Three-layer filter provides NIOSH approved HE filtration from particulate contaminants



ITEM #	ORDER #	DESCRIPTION	UOM
40839	154002401	Powered Air Purifying Respirator	EA



110WH

Pipeliner® Passive Filter Welding Helmet

- » Lightweight SuperGlas Plus material
- » Impervious to moisture and impact-resistant to prevent cracks and chips
- » Specifically designed as a pipe welding helmet
- » Compact design allows access to small spaces and tight clearances where a standard welding helmet won't fit
- » Shade 10 lens for clear viewing

ITEM #	ORDER #	DESCRIPTION	UOM
110WH	614605131	1CR ratchet headgear, 2" x 4 1/4"	EA
110PWE	347688751	1CP rubber headband suspension, 2" x 4"	EA



990GY

Tigerhood™ Thermoplastic Welding Helmets

- » Provides extended throat protection while blocking fumes and smoke from the face
- » Molded from Noryl®
- » Size and shape allow air to circulate
- » Shade 10 filter plate installed
- » 3C free-floating headgear with multiple adjustments
- » SEI Certified

ITEM #	ORDER #	DESCRIPTION	UOM
990GY	614608331	Helmet w/ molded-in glassholder, flash barrier, & wide lens, 4 1/2" x 5 1/4"	EA
5906GY	614607241	Helmet w/ molded-in glassholder, 2" x 4" flip up lens	EA



Horizon™ Safety Glasses

- » Flip-up style lenses
- » Sideshields for extra protection against flying particles
- » Impact-resistant polycarbonate lenses block 99.9% of harmful UVA and UVB radiation
- » Lenses have a scratch-resistant hard coat for longer life
- » Meets ANSI Z87+ (High Impact) standards



S212

ITEM #	ORDER #	DESCRIPTION	UOM
S212	341531301	Infra-dura® Welding Shade 3.0	PR
S213	341531311	Infra-dura® Welding Shade 5.0	PR



Helmets & Filters



Dynaflux Ultraview™ Safety/Cover Lenses

Safety Lenses

- » 100% Polycarbonate Safety Lens
- » Meets or exceeds ANSI Z87.1

Cover Lenses

- » CR-39® Monomer Cover Lens

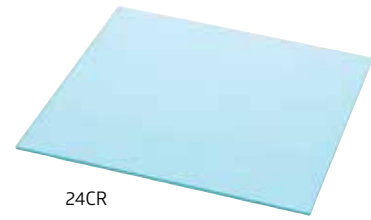

24CR

ITEM #	ORDER #	DESCRIPTION	UOM
SP-1	C23801011	UV24SL Safety Plate, 2" x 4", Clear	EA
SP-5	C23801021	UV45SL Safety Plate, 4" x 5", Clear	EA
24CR	C23821231	UV24CR Cover Lens, 2" x 4 1/4", Clear	EA
45CR	C23821241	UV45CR Cover Lens, 4 1/2" x 5 1/4", Clear	EA

Apparel



6221 & 6120



Flame-Retardant Green Cotton Cape Sleeves and Bib

- » Designed for protection on shoulders, upper chest and arms with increased ventilation on back
- » Sleeves are made from flame-retardant, 9 oz 100% cotton Westex® FR7A®
- » Cool, comfortable, washable. Offers protection from sudden flame exposure, light welding and sparks
- » Snap fasteners
- » Designed for light duty welding only, must keep clean to insure protection

ITEM #	ORDER #	DESCRIPTION	UOM
6221L	C34112321	Cape Sleeves, Large	EA
6221XL	C34121121	Cape Sleeves, XLarge	EA
62212X	C34112601	Cape Sleeves, XXLarge	EA
62213X	C34112611	Cape Sleeves, XXXLarge	EA
6120	C34111451	Bib	EA



Flame-Retardant Green Cotton Coveralls

- » 9 oz, 100% cotton Westex® FR7A®
- » Snap closures
- » Two inside chest pockets, two rear pockets, two front inset pockets
- » Made extra large to fit over clothes
- » Maintains flame resistance for up to 50 home washings at 145°F or 25 commercial washings up to 165°F
- » Designed for light duty welding only, must keep clean to insure protection

ITEM #	ORDER #	DESCRIPTION	UOM
6900L	C34116041	Large	EA
6900XL	C34121711	XLarge	EA
69002X	C34116211	XXLarge	EA
69003X	C34116221	XXXLarge	EA



6900



Apparel



6230



Flame-Retardant Cotton Jackets

- » 9 oz, 100% cotton Westex® FR7A®
- » Snap fasteners
- » 30" length
- » Maintains flame resistance for up to 50 home washings at 145°F or 25 commercial washings up to 165°F
- » Designed for light duty welding only, must keep clean to insure protection

ITEM #	ORDER #	DESCRIPTION	UOM
6230M	C34113051	Green Medium	EA
6230L	C34113041	Green Large	EA
6230XL	C34121481	Green XLarge	EA
62302X	C34113461	Green XXLarge	EA
62303X	C34113471	Green XXXLarge	EA
6230DL	C34112821	Orange Large	EA
6230DXL	C34121291	Orange XLarge	EA
6230D2X	C34112851	Orange XXLarge	EA
6230D3X	C34112861	Orange XXXLarge	EA



6217



Flame-Retardant Green Cotton Sleeves

- » 9 oz, 100% cotton Westex® FR7A®
- » 18" length
- » Designed for light duty welding only, must keep clean to insure protection

ITEM #	ORDER #	DESCRIPTION	UOM
6217	C34112031	2.25" Wide External Elastic at Both Ends	PR
6218	C34112091	Standard Internal Elastic at Both Ends	PR



9030



We Weld America Screen Print Green Jacket

- » 9 oz, 100% cotton Westex® FR7A®
- » Snap fasteners 30" length
- » Colorful "We Weld America" screen print on back
- » Maintains flame resistance for up to 50 home washings at 145°F or 25 commercial washings up to 165°F
- » Designed for light duty welding only, must keep clean to insure protection

ITEM #	ORDER #	DESCRIPTION	UOM
9030L	C34117811	Large	EA
9030XL	C34122031	XLarge	EA
90302X	C34117831	XXLarge	EA



9230



Combination Flame-Retardant Blue Cotton Torso and Leather Sleeves

- » 9 oz, 100% cotton Westex® FR7A® torso
- » Sleeves made from specially tanned side split cowhide
- » Sleeves sewn with Kevlar® thread
- » Soapstone pocket on each sleeve
- » Spacious inside pocket for small item storage
- » 30" length
- » Designed for light duty welding only, must keep clean to insure protection

ITEM #	ORDER #	DESCRIPTION	UOM
9230M	C34118031	Medium	EA
9230L	C34118021	Large	EA
9230XL	C34122091	XLarge	EA
92302X	C34118051	XXLarge	EA
92303X	C34118061	XXXLarge	EA



Apparel



Flame-Retardant Goatskin Sleeves

- » 9 oz, royal blue, Westex® FR7A® FR cotton on upper sleeve
- » Top grain goatskin material from wrist to upper arm for key protection
- » 2.25" wide external elastic secures sleeve to arm
- » 18" leather/cotton length, 22" total length
- » Leather seams are sewn with Kevlar® thread
- » Designed for light duty welding only, must keep clean to insure protection



9215

ITEM #	ORDER #	DESCRIPTION	UOM
9215	C3419215	Goatskin Sleeves	72 Pr/Cs



4118



Cowhide Split Waist and Bib Aprons

- » Bourbon brown side split cowhide
- » 24" x 18" waist apron
- » Waist aprons have heavy duty waist securing apron comfortably
- » Sewn with Kevlar® thread

ITEM #	ORDER #	DESCRIPTION	UOM
4118	C34106511	Waist Apron 24" x 18"	EA
4236	C34106591	Bib Apron 24" x 36"	EA
4242	C34106601	Bib Apron 24" x 42"	EA

⚠ WARNING: Cancer and Reproductive Harm - www.P65Warnings.ca.gov



Cowhide Split Cape Sleeve and Bib

- » Bourbon brown side split cowhide
- » 3120, 20" bib attaches to 3221 cape sleeve for added protection
- » Both cape sleeve and bib are Kevlar® sewn for strength and heat resistance

ITEM #	ORDER #	DESCRIPTION	UOM
3120	C34105791	Leather Bib, 20" length	EA
3221M	C34105891	Leather Cape Sleeve, Medium	EA
3221L	C34105881	Leather Cape Sleeve, Large	EA
3221XL	C34120331	Leather Cape Sleeve, XLarge	EA
32212X	C34106091	Leather Cape Sleeve, XXLarge	EA

⚠ WARNING: Cancer and Reproductive Harm - www.P65Warnings.ca.gov



3120



Cowhide Split Leather Shoe Protector

- » Ankle high, made from tough side split cowhide
- » Rivet reinforced stress points
- » Adjustable straps to secure protector on shoe
- » Sewn with Kevlar® thread



526

ITEM #	ORDER #	DESCRIPTION	UOM
526	C34107251	Ankle High	PR

⚠ WARNING: Cancer and Reproductive Harm - www.P65Warnings.ca.gov



Gloves



1000



Shoulder Split Cowhide Stick Welders Gloves

- » Pearl, shoulder split cowhide
- » 14" length
- » Inside cotton lined for comfort
- » Durable welted fingers protect cotton stitching
- » A lock stitching with cotton thread

ITEM #	ORDER #	DESCRIPTION	UOM
1000	C34100451	Large	PR

⚠️ WARNING: Cancer and Reproductive Harm - www.P65Warnings.ca.gov



Slightly Select Shoulder Split Cowhide Stick Welders Gloves

- » Durable, russet, economy select shoulder split cowhide
- » 14" length
- » Cotton lined for comfort
- » Reinforced thumb
- » Durable welted fingers protect stitching
- » Includes lock stitching with Kevlar® thread for added strength

ITEM #	ORDER #	DESCRIPTION	UOM
1012	C34100691	Large	PR

⚠️ WARNING: Cancer and Reproductive Harm - www.P65Warnings.ca.gov



1012



Select Shoulder Split Cowhide Stick Welders Gloves

- » Durable, blue, slightly select shoulder split cowhide
- » 14" length
- » Insulated with cotton/foam lined material for added heat protection
- » Reinforced thumb
- » Durable welted fingers protect stitching
- » Features lock stitching with Kevlar® thread for added strength



1018

ITEM #	ORDER #	DESCRIPTION	UOM
1018	C34100781	Large	PR
1018XL	C34122491	XLarge	PR

⚠️ WARNING: Cancer and Reproductive Harm - www.P65Warnings.ca.gov



Gloves



1075

Premium Cowhide Split "We Weld America" Stick Welders Gloves

- » Fully featured welding glove with WE WELD AMERICA logo on cuff
- » More durable, premium red, blue and pearl side split cowhide
- » 14" length
- » Insulated with cotton/foam lined material
- » Double reinforced thumb
- » Durable welted fingers protect stitching
- » A lock stitching with Kevlar® thread for added strength

ITEM #	ORDER #	DESCRIPTION	UOM
1075	C34100961	Large	PR

⚠ WARNING: Cancer and Reproductive Harm - www.P65Warnings.ca.gov



1105

Small Hands Stick Welders Gloves

- » Small hands sized, blue, shoulder split cowhide
- » 12" length
- » Cotton/foam lined for added heat protection
- » Durable welted fingers protect stitching
- » A lock stitching with Kevlar® thread for added strength

ITEM #	ORDER #	DESCRIPTION	UOM
1105WBXS	C34118751	XSmall	PR

⚠ WARNING: Cancer and Reproductive Harm - www.P65Warnings.ca.gov



1155

Insulated Extended Cuff Stick Welders Gloves

- » Premium, durable side split cowhide for strength
- » 20" length
- » Cotton/foam lined for moisture absorption and heat protection
- » Insulated extended cuff for added heat protection on forearms
- » Double reinforced wing thumb for extra strength on key stress areas to maximize wear and protection
- » Welted fingers protect stitching from burning and abrasion
- » Sewn with Kevlar® thread for added strength

ITEM #	ORDER #	DESCRIPTION	UOM
1155	C34122731	Large	PR

⚠ WARNING: Cancer and Reproductive Harm - www.P65Warnings.ca.gov



1250

Premium Cowhide Split Stick Welders Gloves

- » More durable, premium blue side split cowhide
- » 14" length
- » Cotton/foam lined for additional heat protection and moisture absorption
- » Double reinforced thumb
- » Durable welted fingers protect stitching
- » Includes lock stitching with Kevlar® thread for added strength

ITEM #	ORDER #	DESCRIPTION	UOM
1250M	C34101321	Medium	PR
1250L	C34101301	Large	PR
1250XL	C34101271	XLarge	PR

⚠ WARNING: Cancer and Reproductive Harm - www.P65Warnings.ca.gov



Gloves



24C



Kidskin TIG Welders Gloves

- » Premium top grain pearl kidskin leather enhances feel and durability
- » Unlined to maximize feel and dexterity
- » 4" cuff for added protection
- » Straight thumb for best gun grip
- » Includes lock stitching with Kevlar® thread for added strength

ITEM #	ORDER #	DESCRIPTION	UOM
24CS	C34105161	Small	PR
24CM	C34105151	Medium	PR
24CL	C34105141	Large	PR
24CXL	C34119951	XLarge	PR

⚠ WARNING: Cancer and Reproductive Harm - www.P65Warnings.ca.gov



30



Pigskin TIG Welders Gloves

- » Made of top grain pearl pigskin, resists oil and water
- » 4" cuff for added protection
- » Straight thumb Includes lock stitching with Kevlar® thread for added strength

ITEM #	ORDER #	DESCRIPTION	UOM
30M	C34105741	Medium	PR
30L	C34105731	Large	PR
30XL	C34120211	XLarge	PR

⚠ WARNING: Cancer and Reproductive Harm - www.P65Warnings.ca.gov



24D



Kidskin TIG Welders Gloves

- » Shorter cuff version of the 24C
- » Premium top grain pearl kidskin leather enhances feel and durability
- » Unlined to maximize feel and dexterity
- » 2" cuff for added protection
- » Straight thumb
- » Includes lock stitching with Kevlar® thread for added strength

ITEM #	ORDER #	DESCRIPTION	UOM
24DS	C34105201	Small	PR
24DM	C34105191	Medium	PR
24DL	C34119971	Large	PR
24DXL	C34120001	XLarge	PR

⚠ WARNING: Cancer and Reproductive Harm - www.P65Warnings.ca.gov



1328



Goatskin TIG Welders Gloves

- » Top grain pearl goatskin leather for superior feel and dexterity
- » Seamless forefinger for enhanced feel
- » 4" cuff, wing thumb
- » Lock stitched with Kevlar® thread for added strength

ITEM #	ORDER #	DESCRIPTION	UOM
1328S	C34101621	Small	PR
1328M	C34101611	Medium	PR
1328L	C34101601	Large	PR
1328XL	C34118871	XLarge	PR

⚠ WARNING: Cancer and Reproductive Harm - www.P65Warnings.ca.gov



Gloves



Insulated Goatskin MIG Welders Gloves

- » A top grain goatskin palm for best feel, cowhide split back resists heat
- » Fleece lined for added heat protection without the bulk
- » Straight thumb for best gun grip
- » Thumb strap reinforcement for extra strength
- » Elastic back for snug fit
- » 3.5" cuff for added protection
- » Sewn with Kevlar® stitching to protect seams

ITEM #	ORDER #	DESCRIPTION	UOM
48M	C34123481	Medium	PR
48L	C34123491	Large	PR
48XL	C34123501	XLarge	PR

WARNING: Cancer and Reproductive Harm - www.P65Warnings.ca.gov



Cowhide MIG Welders Gloves

- » Heavy duty pearl top grain cowhide, unlined
- » 4" cuff for added protection
- » Wing thumb, seamless forefinger for comfort
- » Includes lock stitching with Kevlar® thread for added strength



ITEM #	ORDER #	DESCRIPTION	UOM
1350S	C34101761	Small	PR
1350M	C34101751	Medium	PR
1350L	C34101741	Large	PR
1350XL	C34118961	XLarge	PR

WARNING: Cancer and Reproductive Harm - www.P65Warnings.ca.gov



Insulated Grain Split MIG Welders Gloves

- » Top grain goatskin palm for enhanced feel and dexterity
- » Cowhide split back with elastic for best fit
- » Thumb strap and patch reinforcement for added strength and protection
- » Glide patches on side of palm and cuff eases movement when welding, adds protection
- » Fleece lined for added heat protection without the bulk
- » Longer 5" cuff for additional protection
- » Kevlar® stitching protects seams

ITEM #	ORDER #	DESCRIPTION	UOM
49L	C34101125	Large	PK
49XL	C34101135	XLarge	PK

WARNING: Cancer and Reproductive Harm - www.P65Warnings.ca.gov



Pigskin MIG Welders Gloves

- » Premium heavyweight top grain pigskin
- » Great in wet and oily conditions
- » Unlined palm for dexterity, cotton/foam lined back for added heat protection
- » 4" cuff
- » Straight thumb with added reinforcement strap
- » Includes lock stitching with Kevlar® thread for added strength



ITEM #	ORDER #	DESCRIPTION	UOM
42M	C34106551	Medium	PR
42L	C34106541	Large	PR
42XL	C34120481	XLarge	PR

WARNING: Cancer and Reproductive Harm - www.P65Warnings.ca.gov

Gloves



Reinforced Cowhide MIG Welders Gloves

- » A top grain cowhide palm with cowhide split reinforcements
- » Cowhide split back with elastic for best fit
- » Seamless top grain index finger for best feel
- » Fleece lined for added insulation in hot or cold conditions without the bulk
- » 4" cuff for added protection
- » Sewn with Kevlar® for strength and heat resistance

ITEM #	ORDER #	DESCRIPTION	UOM
50M	C34150501	Medium	PR
50L	C34124501	Large	PR
50XL	C34124511	XLarge	PR

⚠ WARNING: Cancer and Reproductive Harm - www.P65Warnings.ca.gov



50



Premium Elkskin Stick Welders Gloves

- » Pearl premium elkskin stays soft even when hot
- » 14" length
- » Durable welted fingers protect stitching
- » Reinforced thumb
- » Cotton/foam lined back for added heat protection, unlined palm for enhanced dexterity
- » Durable lock stitching with Kevlar® thread for added strength

ITEM #	ORDER #	DESCRIPTION	UOM
750M	C34116661	Medium	PR
750L	C34116651	Large	PR
750XL	C34121841	XLarge	PR

⚠ WARNING: Cancer and Reproductive Harm - www.P65Warnings.ca.gov



750



Premium Gold Elkskin Stick Welders Gloves

- » Gold premium elkskin stays soft even when hot
- » 14" length
- » Durable welted fingers protect stitching
- » Reinforced thumb
- » Cotton/foam lined back for added heat protection, unlined palm for dexterity
- » Lock stitched with Kevlar® thread for added strength

ITEM #	ORDER #	DESCRIPTION	UOM
850M	C34117541	Medium	PR
850L	C34117531	Large	PR
850XL	C34121981	XLarge	PR

⚠ WARNING: Cancer and Reproductive Harm - www.P65Warnings.ca.gov



850



Gloves



Premium Elkskin Stick Welding Glove

- » Elk split leather palm for ultimate comfort
- » Leather back of hand elk split leather
- » Cotton lining and foam insulation for heat resistance
- » Palm reinforcements cow split leather
- » 10" safety cuff
- » Welled seams with Kevlar® stitching for durability and protection in high heat environments
- » Conforms to EN407 413X4X and EN388 Category 2



WSTK-02

ITEM #	ORDER #	DESCRIPTION	UOM
WSTK-02-S	C34804361	Small	PR
WSTK-03-M	C34804371	Medium	PR
WSTK-04-LG	C34804381	Large	PR
WSTK-05-XLG	C34804391	XLarge	PR
WSTK-06-XXLG	C34804441	XXLarge	PR
WSTK-07-XXXLG	C34804451	XXXLarge	PR



Premium MIG Welding Gloves

- » Robust buffalo leather for heat resistance
- » Cow split leather palm
- » Leather back of hand
- » Palm reinforcements
- » 6" safety cuff
- » Welled seams with Kevlar® stitching
- » Conforms to EN407 413X4X and EN388 Category 2



WMIG-02

ITEM #	ORDER #	DESCRIPTION	UOM
WMIG-02-S	C34804321	Small	PR
WMIG-03-M	C34804331	Medium	PR
WMIG-04-LG	C34804341	Large	PR
WMIG-05-XLG	C34804351	XLarge	PR
WMIG-06-XXLG	C34804421	XXLarge	PR
WMIG-07-XXXLG	C34804431	XXXLarge	PR

Backhand Pads



Economy Backhand Pad

- » Standard double layer back-hand pad
- » Top layer Aluminized Rayon (AR)
- » Bottom layer acrylic coated fiberglass
- » Leather and elastic straps
- » Pad measures 5.5"W x 7.5"H



550X

ITEM #	ORDER #	DESCRIPTION	UOM
550X	C34108011	Double-Layer	EA



Premium Backhand Pad

- » Top: Aluminized Carbon Kevlar® (ACK)
- » Middle: Layer of 1500°F melt, ceramic wool material
- » Bottom: Acrylic coated fiberglass
- » Leather and elastic straps
- » 7.5"H x 5.5"W



554

ITEM #	ORDER #	DESCRIPTION	UOM
554	C34108041	Triple-Layer	EA



Standard Backhand Pad

- » Top: Aluminized Carbon Kevlar® (ACK)
- » Bottom: Vermiculite coated fiberglass
- » Leather and elastic straps
- » 7.5"H x 5.50"W



550

ITEM #	ORDER #	DESCRIPTION	UOM
550	C34108001	Double-Layer	EA

Footwear



TREX 6300 Ice Traction Devices

- » One-piece lightweight ice traction device delivers grip and stability for shoes and boots
- » 8 rugged, heat-treated carbon steel studs
- » Stretchable rubber for fit and easy on/off
- » Lightweight, and flexible to -40°F (-40°C)
- » TREX® 6301 replacement studs sold separately

ITEM #	ORDER #	DESCRIPTION	UOM
16753	332103631	Medium - US Mens 5-8	PR
16754	332103641	Large - US Mens 8-11	PR
16755	332103651	XLarge - US Mens 11-15	PR
16756	332103691	XXLarge - US Mens 15-18	PR



16753



TREX 6310 Adjustable Ice Traction Devices

- » Adjustable, one-piece lightweight ice traction device, delivers grip and stability for shoes and boots
- » 10 rugged, heat-treated carbon steel studs
- » Adjustable cord cinches tight for a secure fit
- » Stretchable rubber for fit and easy on/off
- » Tread connects mid-foot and heel stud zones
- » Reflective pull-on tab adds enhanced visibility
- » Flexible to -40°F (-40°C)
- » TREX® 6301 replacement studs sold separately

ITEM #	ORDER #	DESCRIPTION	UOM
16773	332167731	Medium - US Mens 5-8	PR
16774	332163101	Large - US Mens 8-10	PR
16775	332167751	XLarge - US Mens 11-14	PR



16773



Footwear



Honeywell SERVLIS®

SF™ Super-Fit Over Boots

- » Super-sized to fit over bulky leather work boots
- » Seamless, molded, 100% waterproof PVC construction
- » Kick-off lugs permanently molded on the heel for easier removal of overboot
- » Features SF™ Super-Fit wide grip outsole with textured treads for better traction

ITEM #	ORDER #	DESCRIPTION	UOM
11001-L	347610031	12" High Boot/Large	PR
11001-XL	347610041	12" High Boot/XLarge	PR
11003-L	347629621	4" High Overshoe/Large	PR
11003-XL	347629651	4" High Overshoe/XLarge	PR

Honeywell SERVLIS®

CT™ - Comfort Technology PVC 16" Knee Boots

- » Seamless 100% waterproof PVC molded construction
- » Unique Trac10™ outsole pattern anti-skid sole and heel
- » Washable foot form cushion insoles that are removable for easy cleaning
- » Steel toe meets ASTM F2413-05

ITEM #	ORDER #	DESCRIPTION	UOM
18821-8	347630921	Size 8	PR
18821-9	347630931	Size 9	PR
18821-10	347630841	Size 10	PR
18821-11	347630851	Size 11	PR
18821-12	347630861	Size 12	PR
18821-13	347630871	Size 13	PR





Ergonomics



626-M

Value Super Maxx Back Support

- » 8" Breathable Spandex Mesh lumbar panel with elastic stretch panel
- » 4 plastic stays and 2 silicone threaded "Grip Strips"
- » 1.5" wide detachable hook-and-loop closure suspenders
- » Dual panel hook-and-loop closure

ITEM #	ORDER #	DESCRIPTION	UOM
626-M	325308061	Medium	EA
626-L	325308071	Large	EA
626-XL	325308021	XLarge	EA
626-2XL	325308341	XXLarge	EA



OK-SS

Premium Lifter Back Support

- » Durable polyester fabric
- » Internal lumbar support pad
- » Double hook-and-loop closure system
- » Back support width: 5"

ITEM #	ORDER #	DESCRIPTION	UOM
OK-SS-5-M	325377001	Medium	EA
OK-SS-5-L	325377011	Large	EA
OK-SS-5-XL	325377021	XLarge	EA
OK-SS-5-2XL	325377031	XXLarge	EA



310

Elastic Wrist Assist

- » Reduces stress, strains and swelling
- » 3" soft elastic band
- » Hook-and-loop closure

ITEM #	ORDER #	DESCRIPTION	UOM
310	325303101	9", Beige	EA



11093

ProFlex® 1650 Economy Elastic Back Support

- » Economical all-elastic 7.5" (19 cm) body extra firm support
- » 5" (12.7 cm) single strap closure
- » Non-conductive polypropylene stays
- » Adjustable, detachable suspenders

ITEM #	ORDER #	DESCRIPTION	UOM
11092	332116511	Small	EA
11093	332116521	Medium	EA
11094	332116531	Large	EA
11095	332116541	XLarge	EA
11096	332116551	XXLarge	EA
11097	332116561	XXXLarge	EA
11098	332116571	XXXXLarge	EA



OK-UNIV

Classic Universal Back and Abs Support

- » Double hook-and-loop closure system
- » Detachable, 1.5" wide suspenders
- » Rubber grippers help keep belt in place
- » One size fits most (26"-48")
- » Back support width: 9"

ITEM #	ORDER #	DESCRIPTION	UOM
OK-UNIV	325316671	Black	EA

⚠ WARNING: Cancer and Reproductive Harm - www.P65Warnings.ca.gov



OK-NCTS

Premium Carpal Tunnel Support

- » Breathable neoprene support
- » 3" wide wrap around strap
- » Hook-and-loop closure
- » Flexible plastic insert

ITEM #	ORDER #	DESCRIPTION	UOM
OK-NCTS/RM	325322741	Right Wrist	EA



Ergonomics



Ring and Watch Scratch Guards

Ring Guard

- Made of nylon and spandex
- No silicone

Watch Guard

- Made of PVC and polyester
- No silicone



ITEM #	ORDER #	DESCRIPTION	UOM
560	325304381	Ring Guard - Navy	EA
561	325304391	Watch Guard - Black	EA



Wrist Assist with Thumb Loop

- » Reduces stress, strains and swelling
- » 3" black woven elastic
- » Hook-and-loop closure
- » Thumb loop

311-L068



ITEM #	ORDER #	DESCRIPTION	UOM
311-L068	325303231	Black	EA



Classic Fabric Knee Cap Pads

- » Ideal for delicate surfaces
- » Lightweight and comfortable
- » High-density foam body
- » Durable 600 denier polyester
- » Hook-and-loop closure

OK-KP-350-06



ITEM #	ORDER #	DESCRIPTION	UOM
OK-KP-350-06	325309801	Black	PR



Classic Wide Knee Cap Pads

- » Ideal for spreading grout, finishing concrete and most other surfaces
- » EVA foam padding for comfort and cushioning
- » Wide flexible PVC cap provides broad area of protection, durability and ergonomic fit

126



ITEM #	ORDER #	DESCRIPTION	UOM
126	325303181	Blue	PR

WARNING: Cancer and Reproductive Harm - www.P65Warnings.ca.gov



Value Contoured Hard Knee Cap Pads

- » Heavy-duty protection
- » Ideal for most surfaces
- » Abrasion resistant and great for pivoting
- » EVA foam padding provides support and protection
- » PE plastic hard cap
- » Durable polyester and tricot fabrics
- » Hook-and-loop closure

125



ITEM #	ORDER #	DESCRIPTION	UOM
125	325303161	Blue	PR



Premium Flat Cap Gel Knee Pads

- » Ideal for working on hard surfaces, cement, roofs, driveways and cargo areas
- » Gel-injected EVA foam padding to absorb impact and provide superior comfort
- » Flat kneeling surface
- » Polyester, jersey and neoprene fabrics
- » Unique sizing pads assure customized fit
- » Hook-and-loop neoprene split strap closure to avoid bunching and slipping

121



ITEM #	ORDER #	DESCRIPTION	UOM
121	325303131	Black Hard PE Cap	PR



Anchors



00101



Beamer® 2000 Fall Arrest Anchor

- » Fits 3.5" - 14" beams (up to 1.25" thick)
- » Min. Breaking Strength: 5,000 lbs.
- » Perfect for use overhead or at foot level
- » Lightweight and durable
- » Moves smoothly along beam
- » Worker Capacity: 130-420 lbs.

ITEM #	ORDER #	DESCRIPTION	UOM
00101	K62400571	Beamer 2000	EA



Truss Boss Anchor

- » Anchorage connector ideal for fall arrest and restraint applications
- » Easy to install
- » Lightweight and durable
- » Installs upright or inverted
- » Zinc plated and galvanized steel
- » Worker Capacity: 130-310 lbs. - or up to 420 lbs. if used in combination with equipment explicitly certified for such use



00432

ITEM #	ORDER #	DESCRIPTION	UOM
00432	K62400551	Anchorage connector	EA



00500



Ridge-It Anchor

- » Designed for permanent use on wood rooftops
- » 9.75" Single D-ring
- » Easy to install
- » Stainless steel, Zinc-plated steel and Butyl
- » Min. Breaking Strength: 5,000 lbs.
- » Worker Capacity: 130-420 lbs.

ITEM #	ORDER #	DESCRIPTION	UOM
00500	K62400531	Single D-ring roof anchor	EA



01620



Cross Arm Strap

- » Reusable anchorage connector that can be used in a variety of fall protection applications
- » Polyester and galvanized steel
- » Pass-Through Loop Ends
- » Length: 6 ft.
- » Worker Capacity: 130-420 lbs.
- » Min. Breaking Strength: 5,000 lbs.

ITEM #	ORDER #	DESCRIPTION	UOM
01620	K62400421	Reusable anchorage connector	EA



6' Premium Cross Arm Strap

- » Reusable anchorage connector that can be used in a variety of fall protection applications
- » Reinforced webbing for superior durability and functionality
- » Min. Breaking Strength: 5,000 lbs.
- » Worker Capacity: 130-420 lbs.

ITEM #	ORDER #	DESCRIPTION	UOM
10787	K62400281	Reusable anchorage connector	EA





Anchors



2108406



Fixed Beam Anchors

- » Installs onto I-beam flange
- » Attach in any orientation or direction
- » High strength steel and aluminum construction
- » Swiveling D-ring tie-off point
- » Approval/Standards: ANSI A10.32, ANSI Z359.1, OSHA 1910.66, OSHA 1926.502
- » Capable of supporting a load of 5,000 lbs.
- » Weight Capacity: 310 lbs. (141 kg) ANSI / 420 lbs. (190 kg) OSHA
- » More lengths available

ITEM #	ORDER #	DESCRIPTION	UOM
2108406	458036011	Fits 2.5" to 12" (6.3-30.5 cm) Wide I-Beams up to 1.5" thick (3.8 cm)	EA
2108407	458036921	Fits 2.5" to 18" (6.3-45.7cm) wide I-Beam up to 1.5" thick (3.8cm)	EA
2108408	458084081	Fits 2.5" to 24" (6.3-61cm) wide I-Beam up to 1.5" thick (3.8cm).	EA
2108410	458084101	Fits 12" to 36" (30.5-91.4cm) wide I-Beam up to 0.5" to 2.5" thick (1.3-6.3cm).	EA



2101630



D-Rings with Anchorage Plate

- » Bolt or weld to structure for fall arrest anchor point
- » 304 stainless steel plate, pre-drilled holes
- » D-ring for compatible tie-off point
- » Approval/Standards: ANSI A10.32, ANSI Z359.1, OSHA 1910.66, OSHA 1926.502
- » Capable of supporting a load of 5,000 lbs.
- » Weight Capacity: 310 lbs. (141 kg) ANSI / 420 lbs. (190 kg) OSHA

ITEM #	ORDER #	DESCRIPTION	UOM
6.35 x 50 x 115 mm Plate, Pre-Drilled 14 mm Holes			
2101630	458016301	Zinc Plated Steel D-Ring	EA



1003000



Tie-Off Adapters

- » Pass-thru type tie-off adapter
- » Polyester construction, abrasion resistant wear pad and steel hardware
- » Approval/Standards: ANSI Z359.1, OSHA 1910.66, OSHA 1926.502
- » Capable of supporting a load of 5,000 lbs.
- » Weight Capacity: 310 lbs. (141 kg) ANSI / 420 lbs. (190 kg) OSHA

ITEM #	ORDER #	DESCRIPTION	UOM
1003000	458030001	Yellow, 3 Ft. Long	EA
1003006	458035001	Yellow, 6 Ft. Long	EA



5900578



PRO™ Tie-Off Adapter

- » Pass-thru type tie-off adapter
- » Durable polyester construction
- » High strength steel hardware
- » Approval/Standards: ANSI Z359.1, OSHA 1910.66, OSHA 1926.502
- » Capable of supporting a load of 5,000 lbs.
- » Weight Capacity: 310 lbs. (141 kg) ANSI / 420 lbs. (190 kg) OSHA

ITEM #	ORDER #	DESCRIPTION	UOM
5900577	458005881	Red, 3 Ft. Long	EA
5900578	458005871	Red, 6 Ft. Long	EA



Anchors



T7314



Titan™ II Anchorage Strap

- » Webbing cross-arm strap wraps around I-beams and other structures
- » Attaches with a D-ring that slips through a web loop
- » Meets all applicable OSHA, ANSI and CSA standards

ITEM #	ORDER #	DESCRIPTION	UOM
T7314/6FTAF	341506661	Hi-Viz Orange, 6 Ft. Long	EA



Miller Grip™ 3/4" Portable/Reusable Anchorage Connectors

- » A safe anchor point is established when the anchor is inserted into a 3/4" properly-sized, cured concrete hole
- » Anchor can be removed and re-installed in a new location
- » Designed for use in cured concrete with a compression strength of at least 3,000 psi
- » Tested: ANSI Z359.1
- » Strength: 5,000 lbs.
- » Weight Capacity: 400 lbs.



496



ITEM #	ORDER #	DESCRIPTION	UOM
496	341508031	Anchorage Connector	EA



The Safety Company

Workman® FP Stryder™ Anchorage Connectors

- » Easy, single-hand installation, 1/4" push-button interval adjustment
- » Teflon® wear pads enable gliding along beam flange
- » Integral load indicator alerts user if unit has been exposed to a fall
- » Mount overhead or at worker's feet
- » 400 lbs. working capacity
- » Specifications: ANSI Z359.1, OSHA



10144431

ITEM #	ORDER #	DESCRIPTION	UOM
10144431	308544331	Fits Beam Flange Widths 4" to 13.5"	EA

Carabiners



17D-1



Miller Carabiners

- » Twist lock carabiners with spring loaded keepers
- » Used as anchorage connectors
- » Zinc dichromate plated forged alloy steel
- » Proof tested 3600 lbs., Min tensile strength 5,000 lbs. and Max working load 400 lbs.
- » Meets or exceeds OSHA 1926.502, ANSI Z359-2007 and CSA Z259.12 requirements

ITEM #	ORDER #	DESCRIPTION	UOM
17D-1	34150171	1" Gate Opening	EA
18D-1	341506821	2" Gate Opening	EA



Fall Protection



2000112



2000114

Saflok™ Carabiners

- » Self-closing and locking gate for added safety
- » Highly corrosion resistant plated hardware
- » High strength steel construction
- » Approval/Standards: ANSI Z359.1, OSHA 1910.66, OSHA 1926.502
- » Capable of supporting a load of 5,000 lbs.
- » Weight Capacity: 310 lbs. (141 kg) ANSI / 420 lbs. (190 kg) OSHA

ITEM #	ORDER #	DESCRIPTION	UOM
2000112	458011121	0.6875" (17.5 mm) Gate Opening	EA
Double Action Autolok Gate, ANSI A10.32			
2000114	458020151	2.1875" (55.5 mm) Gate Opening	EA



D-Rings



1385000



PRO D-Ring Extension

- » Extends dorsal harness D-ring (or overhead anchor point)
- » Abrasion resistant polyester webbing
- » Self-locking snap hook and D-ring tie-off point
- » Approval/Standards: OSHA 1910.140, OSHA 1926.502
- » Weight Capacity: 310 lbs. (141 kg)

ITEM #	ORDER #	DESCRIPTION	UOM
1385000	458050011	1.5 Ft. Long	EA



1231117



D-Ring Extensions

- » Extends dorsal harness D-ring (or overhead anchor point)
- » Polyester webbing with built-in wear indicator
- » Self-locking snap hook and D-ring tie-off point
- » Equipped with i-Safe™ intelligent safety system RFID-enabled
- » Approval/Standards: ANSI Z359.3, OSHA 1926.502, OSHA 1910.140
- » Weight Capacity: 310 lbs. (141 kg)

ITEM #	ORDER #	DESCRIPTION	UOM
1231117	458036691	Yellow, 1.5 Ft. Long	EA

Fall Limiters



FL11-3-Z7



MiniLite® Fall Limiters

- » Lightweight, 2.5 lbs. (1.1 kg)
- » Up to 11 ft. (3.3m) of working capacity
- » Stainless steel braking system
- » Protective outer cover; visual load indicator
- » Unit connector: Steel twist-lock carabiner and swivel shackle
- » Lanyard end connector: Locking snap hook
- » ANSI Z359 Compliant

ITEM #	ORDER #	DESCRIPTION	UOM
FL11-3-Z7/11FT	341558351	11 Ft. Long Limiter	EA



MFL-1-Z7



TurboLite™ Personal Fall Limiter

- » Attaches directly to the back D-ring of a harness
- » Integral swivel prevents lifeline from twisting
- » Nylon housing and abrasion-resistant webbing
- » Unit connector: Steel twist-lock carabiner and swivel shackle
- » Rated for up to a 400 lb. (181.4 kg) worker
- » Meets requirements of OSHA, ANSI Z359.14 Class A & B and CSA Z259.2.2

ITEM #	ORDER #	DESCRIPTION	UOM
--------	---------	-------------	-----

Lanyard End Connector: Locking Snap Hook

MFL-1-Z7/6FT	341557191	6 Ft. Long Limiter	EA
--------------	-----------	--------------------	----

Lanyard End Connector: Locking Rebar Hook

MFL-2-Z7/6FT	341564001	6 Ft. Long Limiter	EA
--------------	-----------	--------------------	----

Fall Limiters

Honeywell
MILLER

Scorpion™ Personal Fall Limiters

- » Greater versatility through dual operation: attach directly to the harness D-ring for use as a personal fall limiter, or use as a traditional retractable lifeline
- » Small, lightweight design 2.9 lbs. (1.3 kg)
- » Unit connector: Carabiner and swivel shackle
- » Lanyard end connector: Locking snap hook
- » Rated for up to a 400 lb. (181.4 kg) worker
- » Visual load indicator – indicates the unit must be removed from service
- » ANSI Z359 Compliant



ITEM #	ORDER #	DESCRIPTION	UOM
PFL-4-Z7/9FT	341558361	9 Ft. Long Limiter	EA

Honeywell
MILLER

Turbo T-BAK™ Personal Fall Limiters

- » 7.5 ft. (2.3 m) working capacity
- » All-in-one, self-retracting lifeline/anchorage connector design
- » Designed for anchoring below a user's harness back D-ring
- » Integrated shock absorber designed for tie-back applications with load indicator device
- » Rated for up to a 400 lb. (181.4 kg) worker
- » ANSI Z359-compliant snap hook
- » Meets OSHA 1926.502, 1910.66, ANSI A10.32, ANSI Z359.1 and CSA Z259.12-01 Class 1, Z259.2.2-98 Type 1 requirements



ITEM #	ORDER #	DESCRIPTION	UOM
MFLT-5/7.5FT	341566461	7.5 Ft. Long Limiter	EA

Twin Turbo D-Ring Connector with (2) MFLT-1/7.5FT Units			
ITEM #	ORDER #	DESCRIPTION	UOM
MFLTB-1/7.5FT	341566471	(2) 7.5 Ft. Long Limiters	EA

MSA
The Safety Company

Workman® Mini Personal Fall Limiter

- » Internal pawl-lock design provides many lower level tie-off points
- » Retractable lifeline
- » Swivel eye connection
- » 400 lb. user weight capacity
- » Rugged, impact resistant housing
- » External energy absorber provides visual load indicator for easy inspection
- » ANSI Z359.14, Class A, CSA Z259.2.2, OSHA, EN 360:2002



ITEM #	ORDER #	DESCRIPTION	UOM
10157844	308578441	Single Leg, 6 Ft. Long Limiter w/ AL36C Connector	EA



1500090



Battery Holster/Sleeve

- » Battery holster provides attachment point for tool lanyard
- » Sleeve is simply cinched to the drill
- » 10 lbs. (4.5 kg) capacity

ITEM #	ORDER #	DESCRIPTION	UOM
1500090	458055901	Black and Yellow	EA

Fall Protection for Tools



1500047



Hook2Loop Bungee Tethers

- » Designed to be used with most small hand tools
- » Self-Locking carabiner
- » 0.625" tubular webbing
- » Weight Capacity: 15 lbs. (6.8 kg)

ITEM #	ORDER #	DESCRIPTION	UOM
1500047	458055471	Yellow, Stretches 32" to 47" Long	EA



1500119



Small Parts Pouch

- » Innovative self-closure system
- » Easy to retrieve objects since no opening or closing necessary
- » Can be used from a belt or harness
- » Made from 18 oz. duck canvas

ITEM #	ORDER #	DESCRIPTION	UOM
1500119	458056191	Black	EA



1500104



Single Tool Holster

- » Single tool harness holster with retractor
- » Neoprene pocket with retractor
- » Bottom drain vent
- » High visibility reflectors
- » Magnetic tool staging system holds tools in place

ITEM #	ORDER #	DESCRIPTION	UOM
1500104	458056041	Black	EA



1500096



Scaffold Wrench Holster

- » Belt scaffold wrench holster with rear-feed retractor
- » Hook and loop closure strap keeps tools secure
- » D-Ring connection points bolster, 5 lbs. (2.3 kg) capacity
- » High visibility reflectors
- » Rear-feed retractor system with 1.5 lbs. (0.7 kg) capacity

ITEM #	ORDER #	DESCRIPTION	UOM
1500096	458055961	Black	EA



1500140



Safe Bucket

- » Heavy-duty vinyl is easy to clean
- » Innovative hook and loop closure system
- » Carabiner and hoisting strap
- » Six built-in connection points with 4.5 kg load rating each
- » Puncture resistant plating sewn into the base of the bucket
- » 250 lb. (113.4 kg) capacity

ITEM #	ORDER #	DESCRIPTION	UOM
1500140	458056401	Black and Yellow	EA



Fall Protection for Tools



1500003

D-Ring

- » Creates instant attachment points
- » 0.5" D-Ring attachment point
- » Weight Capacity: 2 lbs. (0.9 kg)

ITEM #	ORDER #	DESCRIPTION	UOM
1500003	45805503	Yellow, 2.25" x 0.5"	10/Cs

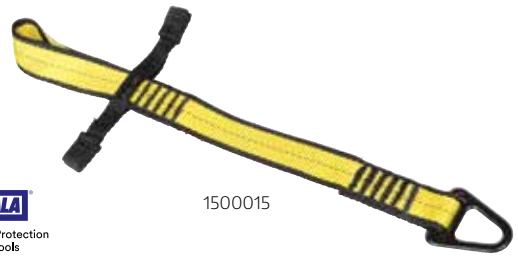

1500015



Tool Cinch Attachment

- » V-Ring attachment point
- » Simple cinch design
- » Dual stabilization wings can be used to secure cinch in place
- » 35 lbs. (15.9 kg) capacity

ITEM #	ORDER #	DESCRIPTION	UOM
1500015	458055151	Yellow	EA



1500029



Quick Spins

- » Tangle-resistant spin top
- » Reusable and suitable for non-conductive use
- » 1 lb. (0.5 kg) capacity, 1" diameter

ITEM #	ORDER #	DESCRIPTION	UOM
1500029	45805529	Yellow, Large	10/Cs

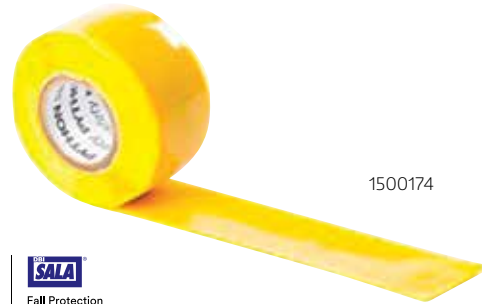

1500174



Heavy-Duty Quick Wrap Tape II

- » Redesigned Quick-Wrap Tape II helps deliver long-lasting tool attachment performance
- » Creates instant tethering points
- » Resists tears better
- » Stretches further
- » Quick and easy installation

ITEM #	ORDER #	DESCRIPTION	UOM
1500174	458004891	Yellow, 1" Wide x 9 Ft. Long	EA



Bandit™ Tool Lanyard

- » Attaches to the user's belt
- » Tools are attached with the carabiner or by cinching the cord around tool

ITEM #	ORDER #	DESCRIPTION	UOM
9077/1	341510611	Tool Lanyard	EA

9077/1



Fall Protection for Tools



19650



19651



19652

Squids Tool Tethering Kits

- » **19650** - Squids 3180 Tethering Kit includes: (1) 3130S coil lanyard, (1) 12 ft. (3.7 m) roll of 3755 self-adhering tape trap and (6) 3700 web tool tails. This kit allows you to tether up to six 2 lb. (0.9 kg) tools
- » **19651** - Squids 3181 Tethering Kit includes: (1) 3102F(x) detachable single carabiner lanyard, (1) 12 ft. (3.7 m) roll of 3755 self-adhering tape trap and (3) 3103 detachable elastic tool tails. This kit allows you to tether up to four 5 lb. (2.3 kg) tools
- » **19652** - Squids 3182 Tethering Kit includes: (1) 3100F(x) single carabiner tool lanyard, (1) 12 ft. (3.7m) roll of 3755 self-adhering tape trap and (3) 3713 swiveling elastic tool tails. This kit allows you to tether up to three 10 lb. (4.5 kg) tools

ITEM #	ORDER #	DESCRIPTION	WEIGHT RATING	UOM
19650	332101451	3180 Tool Tethering Kit	2 lb. (0.9 kg)	EA
19651	332101441	3181 Tool Tethering Kit	5 lb. (2.3 kg)	EA
19652	332101361	3182 Tool Tethering Kit	10 lb. (4.5 kg)	EA



19660



19661



19662

Squids Specialty Tool Tethering Kits

- » **19660** - Squids 3190 Tape Measure Tethering Kit includes: (1) 3130S coil lanyard and (1) 3770 tape measure trap. This kit allows you to tether (1) standard 2 lb. (0.9 kg) tape measure
- » **19661** - The Squids 3191 Power Tool Tethering Kit includes: (1) 3100F(x) single carabiner tool lanyard and (1) 3780L power tool trap. This kit allows you to tether (1) standard 6 lb. (2.7 kg) power tool
- » **19662** - The Squids 3192 Wrist Lanyard Tethering Kit includes: (1) 3116 pull-on wrist lanyard with buckle, (1) 12 ft. roll (3.7 m) of 3755 self-adhering tape trap and (3) 3103 detachable elastic tool tails. This kit allows you to tether up to (4) 3 lb. (1.4 kg) tools

ITEM #	ORDER #	DESCRIPTION	UOM
19660	332101351	3190 Tape Measure Tethering Kit	EA
19661	332101331	3191 Power Tool Tethering Kit	EA
19662	332101321	3192 Wrist Lanyard Tethering Kit	EA



Harnesses



Series 1 Harnesses

- » Perfect entry-level harness solution
- » Captivated chest strap
- » Dual lanyard keepers
- » 2-Bar torso adjuster
- » Rubber web ends
- » Impact indicator
- » Polyester webbing
- » Galvanized Steel D-ring
- » Capacity: 130-420 lbs



37002

ITEM #	ORDER #	DESCRIPTION	UOM
37000	K62400141	Size: XS-S, Chest & Leg Pass-Through Buckles	EA
37001	K62400131	Size: M-L, Chest & Leg Pass-Through Buckles	EA
37002	K62400121	Size: XL-2XL, Chest & Leg Pass-Through Buckles	EA
37016	K62400111	Size: XS-S, Chest Quick-Connect, Leg Tongue Buckles	EA
37017	K62400101	Size: M-L, Chest Quick-Connect, Leg Tongue Buckles	EA
37018	K62400091	Size: XL-2XL, Chest Quick-Connect, Leg Tongue Buckles	EA



37117



Series 3 Harnesses

- » Focuses on comfort and performance
- » Captivated chest strap
- » Lanyard keepers
- » Heavy-duty waist pad
- » Spring torso adjuster
- » Snap-on shoulder padding
- » SRL connector loop
- » Impact indicator
- » Polyester webbing
- » Galvanized Steel D-ring
- » Capacity: 130-420 lbs

ITEM #	ORDER #	DESCRIPTION	UOM
37116	K62400081	Size: XS-S, Chest Quick-Connect, Leg Tongue Buckles	EA
37117	K62400071	Size: M-L, Chest Quick-Connect, Leg Tongue Buckles	EA
37118	K62400061	Size: XL-2XL, Chest Quick-Connect, Leg Tongue Buckles	EA
37196	K62400051	Size: XS-S, Chest Quick-Connect, Leg Tongue Buckles, & Waist Pad	EA
37197	K62400041	Size: M-L, Chest Quick-Connect, Leg Tongue Buckles, & Waist Pad	EA
37198	K62400031	Size: XL-2XL, Chest Quick-Connect, Leg Tongue Buckles, & Waist Pad	EA



Seraph Construction Harness w/Side D-Rings

- » Heavy duty and comfortable waist pad with strong belt loops
- » Reinforced tool belt which won't sag or fold under heavy weights
- » Dorsal D-ring
- » Pass-through chest strap
- » Tongue-buckle leg straps
- » Two lanyard keepers
- » Durable back placard
- » Removable/replaceable back and shoulder padding



11173

ITEM #	ORDER #	DESCRIPTION	UOM
11173	K62400201	Size: M-L, Pass-Through Chest Buckles, Leg Tongue Buckles	EA
11171	K62400211	Size: XL-2XL, Pass-Through Chest Buckles, Leg Tongue Buckles	EA



Harnesses



01703



01705



Velocity Full-Body Harnesses

- » 5 Points of adjustment
- » Pass-through chest strap
- » Tongue buckle leg straps
- » Dorsal D-ring
- » Padded D-ring placard
- » Impact indicator
- » Sub-pelvic strap
- » Dual lanyard keepers
- » Contrasting core webbing to indicate wear and aid inspection
- » Capacity: 130-420 lbs.

ITEM #	ORDER #	DESCRIPTION	UOM
01703	K62400411	Size: S-L, Pass-Through Chest Buckles, Leg Tongue Buckles, Dorsal D-ring	EA
01704	K62400401	Size: XL-2XL, Pass-Through Chest Buckles, Leg Tongue Buckles, Dorsal D-ring	EA
01705	K62400391	Size: S-L, Pass-Through Chest Buckles, Leg Tongue Buckles, Side D-rings	EA



Bucket of Safe-Tie w/ Temper Anchor

- » Incorporates an integrated shock absorber into the lifeline
- » Temper Reusable Anchor
- » 50 ft. Vertical lifeline assembly
- » Steel, polyester, and nylon
- » Velocity harness (S-L)
- » 5 Gallon bucket
- » Capacity: 130-310 lbs.

00815



ITEM #	ORDER #	DESCRIPTION	UOM
00815	K62400491	Size: S-L, Bucket of Safe-Tie	EA



1100633



Delta™ Comfort Construction Style Positioning/Climbing Harness

- » Built-in shoulder, back and leg comfort padding
- » Front D-ring, fixed back D-ring
- » Rigid body belt and hip pad with side D-rings
- » Tongue buckle leg straps, polyester webbing
- » Built-in lanyard keepers with break-away feature
- » Revolver™ vertical torso adjusters
- » Impact indicator, protected labels and equipped with i-Safe™
- » ANSI Z359.1, ANSI Z359.3, OSHA 1910.66, OSHA 1926.502
- » Weight Capacity: 420 lbs. (190 kg)

ITEM #	ORDER #	DESCRIPTION	UOM
1100633	458034691	Yellow, Size Medium	EA
1100634	458034711	Yellow, Size Large	EA



Harnesses



1100747



Delta™ Comfort Vest Style Harnesses

- » Built-in shoulder, back and leg comfort padding
- » Fixed back D-ring
- » Tongue buckle leg straps, polyester webbing
- » Built-in lanyard keepers with break-away feature
- » Revolver™ vertical torso adjusters, loops for body belt
- » Impact indicator, protected labels and equipped with i-Safe™
- » ANSI Z359.1, ANSI Z359.3, OSHA 1910.66, OSHA 1926.502
- » Tensile Strength: 6000 lb., Weight Capacity: 420 lbs. (190 kg)

ITEM #	ORDER #	DESCRIPTION	UOM
1100747	458000741	Yellow, Size Large	EA
1100748	458000761	Yellow, Size XLarge	EA



1110600



Delta™ Vest Style Harnesses

- » Stand-up back D-ring
- » Repel™ webbing
- » Built-in lanyard keepers
- » Revolver™ vertical torso adjusters
- » Impact indicator, protected labels and equipped with i-Safe™
- » ANSI Z359.11
- » Tensile Strength: 6000 lb.
- » Weight Capacity: 420 lbs. (190 kg)

ITEM #	ORDER #	DESCRIPTION	UOM
Tech-Lite™ Quick-Connect Buckle Leg Straps			
1110600	458010601	Yellow, Size Universal	EA
Tongue Buckle Leg Straps			
1102000	458020021	Yellow, Size Universal	EA
Tongue Buckle Leg Straps, Side D-Rings			
1102008	458020061	Yellow, Size Universal	EA
Pass-Thru Buckle Leg Straps			
1103321	458035041	Yellow, Size Universal	EA



1101655



Delta™ Construction Style Positioning Harness

- » Stand-up back D-ring
- » Body belt/hip pad with side D-rings
- » Tongue buckle leg straps, shoulder pads
- » Repel™ webbing, built-in lanyard keepers
- » Revolver™ vertical torso adjusters
- » Impact indicator, protected labels and equipped with i-Safe™
- » ANSI Z359.11
- » Tensile Strength: 6000 lb.
- » Weight Capacity: 420 lbs. (190 kg)

ITEM #	ORDER #	DESCRIPTION	UOM
1101654	458035011	Yellow, Size Medium	EA
1101655	458035021	Yellow, Size Large	EA



Harnesses



Delta™ II Derrick Harnesses

- » 18" back D-ring extension
- » Body belt/hip pad with back D-ring
- » Seat sling with positioning D-rings
- » Tongue buckle leg straps
- » Parachute torso buckles
- » Protected labels and equipped with i-Safe™
- » ANSI A10.32, ANSI Z359.1, OSHA 1910.66, OSHA 1926.502
- » Weight Capacity: 420 lbs. (190 kg)



1106101

ITEM #	ORDER #	DESCRIPTION	UOM
1106101	458061011	Yellow, Size Medium	EA
1106102	458061021	Yellow, Size Large	EA
1106103	458061031	Yellow, Size XLarge	EA



ExoFit™ Vest Style Harnesses

- » Built-in shoulder, back and leg comfort padding
- » Back D-ring
- » Quick connect chest and leg straps
- » Soft, lightweight webbing, loops for body belt
- » Anti-tear ballistic nylon
- » Built-in reflective piping
- » Parachute torso buckles
- » Protected labels and equipped with i-Safe™
- » ANSI A10.32, ANSI Z359.1, ANSI Z359.4, OSHA 1926.502
- » Tensile Strength: 6000 lb., Weight Capacity: 420 lbs. (190 kg)



1107975

ITEM #	ORDER #	DESCRIPTION	UOM
1107975	458079751	Blue, Size Small	EA
1107976	458079761	Blue, Size Medium	EA
1107977	458079771	Blue, Size Large	EA
1107981	458079811	Blue, Size XLarge	EA



ExoFit™ XP Vest Style Harnesses

- » Removable shoulder, back and leg comfort padding
- » Stand-up back D-ring with impact indicator
- » Quick connect chest and leg straps
- » Loops for body belt
- » Built-in lanyard keepers
- » Parachute torso buckles
- » Protected labels and equipped with i-Safe™
- » ANSI A10.32, ANSI Z359.1, ANSI Z359.4, OSHA 1910.66, OSHA 1926.502
- » Tensile Strength: 6000 lb., Weight Capacity: 420 lbs. (190 kg)



1110101

ITEM #	ORDER #	DESCRIPTION	UOM
1110101	458001011	Blue, Size Medium	EA
1110102	458001021	Blue, Size Large	EA



Harnesses

1110152



ExoFit™ XP Construction Style Harnesses

- » Removable shoulder, back and leg comfort padding
- » Stand-up back D-ring with impact indicator
- » Body belt/hip pad with side D-rings
- » Quick connect chest and leg straps
- » Built-in lanyard keepers
- » Parachute torso buckles
- » Protected labels and equipped with i-Safe™
- » ANSI A10.32, ANSI Z359.1, ANSI Z359.4, OSHA 1910.66, OSHA 1926.502
- » Tensile Strength: 6000 lb., Weight Capacity: 420 lbs. (190 kg)

ITEM #	ORDER #	DESCRIPTION	UOM
1110152	458001521	Blue, Size Large	EA



ExoFit™ XP Arc Flash Harnesses

- » Removable Nomex®/Kevlar® fiber shoulder, back and leg comfort padding
- » PVC coated back D-ring, pass-thru buckle leg straps and pass-thru torso buckles
- » Nomex®/Kevlar® fiber webbing
- » Arc flash resistant up to 40 cal/cm²
- » Protected labels and equipped with i-Safe™
- » ANSI Z359.1, ASTM F887, OSHA 1910.66, OSHA 1926.502
- » Tensile Strength: 7000 lb., Weight Capacity: 420 lbs. (190 kg)



1110893

ITEM #	ORDER #	DESCRIPTION	UOM
1110893	458018931	Black, Size Small	EA
1110890	458008901	Black, Size Medium	EA
1110891	458008911	Black, Size Large	EA
1110892	458008921	Black, Size X-Large	EA



ExoFit STRATA™ Construction Style Positioning/Climbing Harnesses

- » LIFTech™ weight distribution system
- » PolarMesh™ back pad, EZ-Link™ SRL adapter
- » Tri-Lock Revolver™ quick connect buckles
- » Stand-up Tech-Lite™ aluminum dorsal D-ring
- » Body belt/hip pad with thermoformed EVA padding and Tech-Lite™ aluminum side D-rings
- » Snap and Go Tech-Lite™ aluminum front D-ring
- » Repel™ webbing, built-in lanyard keepers that automatically reset
- » ANSI Z359.1, ANSI Z359.11, OSHA 1910.66, OSHA 1926.502
- » Weight Capacity: 420 lbs. (190 kg)



1112540

ITEM #	ORDER #	DESCRIPTION	UOM
1112540	458025401	Blue and Gray, Size Small	EA
1112541	458025411	Blue and Gray, Size Medium	EA
1112542	458025421	Blue and Gray, Size Large	EA

Harnesses



ExoFit STRATA™ Construction Style Positioning Harnesses

- » LIFTech™ weight distribution system
- » PolarMesh™ back pad, EZ-Link™ SRL adapter
- » Tri-Lock Revolver™ quick connect buckles
- » Stand-up Tech-Lite™ aluminum dorsal D-ring
- » Body belt/hip pad with thermoformed EVA padding and Tech-Lite™ aluminum side D-rings
- » Repel™ webbing, built-in lanyard keepers that automatically reset
- » Impact Indicator, integrated suspension trauma straps
- » Customizable name tag, protected labels and equipped with i-Safe™
- » ANSI Z359.1, ANSI Z359.11, OSHA 1910.66, OSHA 1926.502
- » Weight Capacity: 420 lbs. (190 kg)

ITEM #	ORDER #	DESCRIPTION	UOM
1112536	458025361	Blue and Gray, Size Medium	EA
1112537	458025371	Blue and Gray, Size Large	EA



ExoFit NEX™ Vest Style Harnesses

- » Hybrid shoulder, back and leg comfort padding
- » Stand-up Tech-Lite™ aluminum back D-ring
- » Duo-Lok™ quick connect chest and leg straps
- » Repel™ webbing, protective shoulder caps and loops for body belt
- » Built-in lanyard keepers, Revolver™ vertical torso adjusters
- » Built-in reflective materials, protected labels and equipped with i-Safe™
- » ANSI A10.32, ANSI Z359.1, ANSI Z359.4, OSHA 1910.66, OSHA 1926.502
- » Tensile Strength: 6000 lb., Weight Capacity: 420 lbs. (190 kg)

ITEM #	ORDER #	DESCRIPTION	UOM
1113001	458036381	Gray, Size Small	EA
1113004	458036391	Gray, Size Medium	EA
1113007	458036401	Gray, Size Large	EA
1113010	458036411	Gray, Size XLarge	EA



ExoFit NEX™ Construction Style Harnesses

- » Stand-up Tech-Lite™ aluminum back D-ring
- » Body belt/hip pad with Tech-Lite™ aluminum side D-rings
- » Duo-Lok™ quick connect chest and leg straps
- » Repel™ webbing and protective shoulder caps
- » Built-in lanyard keepers, Revolver™ vertical torso adjusters
- » Impact Indicator, integrated trauma straps
- » Built-in reflective materials, protected labels and equipped with i-Safe™
- » ANSI A10.32, ANSI Z359.1, ANSI Z359.4, OSHA 1910.66, OSHA 1926.502
- » Tensile Strength: 6000 lb., Weight Capacity: 420 lbs. (190 kg)

ITEM #	ORDER #	DESCRIPTION	UOM
1113121	458036421	Gray, Size Small	EA
1113124	458036431	Gray, Size Medium	EA
1113127	458036441	Gray, Size Large	EA
1113130	458036451	Gray, Size XLarge	EA



Harnesses



ExoFit STRATA™ Vest-Style Harness

- » PolarMesh™ back pad, EZ-Link™ SRL adapter
- » Duo-Lok™ quick connect chest and leg straps
- » Stand-up Tech-Lite™ aluminum dorsal D-ring
- » Repel™ webbing, built-in lanyard keepers that automatically reset
- » Revolver™ vertical torso adjusters
- » Impact Indicator, integrated suspension trauma straps
- » Fall protection for tools attachment point
- » ANSI Z359.11, Weight Capacity: 420 lbs. (190 kg)

1112497



ITEM #	ORDER #	DESCRIPTION	UOM
1112497	458006031	Blue and Gray, Size Large	EA



ExoFit STRATA™ Vest-Style Harness

- » PolarMesh™ back pad, EZ-Link™ SRL adapter
- » Tri-Lock Revolver™ quick connect buckles
- » Stand-up Tech-Lite™ aluminum dorsal D-ring
- » Repel™ webbing, built-in lanyard keepers that automatically reset
- » Revolver™ vertical torso adjusters
- » Impact Indicator, integrated suspension trauma straps
- » Customizable name tag, protected labels and equipped with i-Safe™
- » ANSI Z359.11, Weight Capacity: 420 lbs. (190 kg)

1112475



ITEM #	ORDER #	DESCRIPTION	UOM
1112475	458005891	Blue and Gray, Size Small	EA
1112476	458005921	Blue and Gray, Size Medium	EA
1112477	458005931	Blue and Gray, Size Large	EA
1112478	458005941	Blue and Gray, Size XLarge	EA
1112479	458005951	Blue and Gray, Size 2XLarge	EA



ExoFit STRATA™ Vest-Style Positioning Harness

- » PolarMesh™ back pad, EZ-Link™ SRL adapter
- » Tri-Lock Revolver™ quick connect buckles
- » Stand-up Tech-Lite™ aluminum dorsal D-ring
- » Tech-Lite™ aluminum side D-rings
- » Repel™ webbing, built-in lanyard keepers that automatically reset
- » Revolver™ vertical torso adjusters
- » Impact Indicator, integrated suspension trauma straps
- » Customizable name tag, protected labels and equipped with i-Safe™
- » Fall protection for tools attachment point
- » Weight Capacity: 420 lbs. (190 kg), ANSI Z359.11

1112482



ITEM #	ORDER #	DESCRIPTION	UOM
1112482	458006071	Blue and Gray, Size Large	EA



Harnesses



Protecta® Construction Style Positioning Harness



1161309

- » Fixed D-ring reduces the need for readjustment throughout the workday
- » Moisture-wicking, breathable back padding with soft edging for added comfort
- » Foam hip pad with mesh provides extra comfort and breathability
- » Durable and sturdy belt for tool bag-carrying convenience
- » ANSI-compliant auto-resetting lanyard keepers for fast and easy parking of snap hooks and carabiners
- » Impact indicators make it easy to inspect the harness for prior damaging impact loads
- » ANSI Z359.11, OSHA 1926.502
- » Tensile Strength: 3600 lb., Weight Capacity: 420 lbs. (190 kg)

ITEM #	ORDER #	DESCRIPTION	UOM
1161309	458006611	Red and Black, Size Medium/Large	EA
1161310	458006631	Red and Black, Size X-Large	EA



FIRST™ Vest Style Harnesses

- » Back D-ring
- » Pass-thru buckle leg straps
- » Parachute torso adjusters
- » Durable polyester web construction
- » ANSI Z359.11, ANSI Z359.1, OSHA 1910.66, OSHA 1926.502
- » Tensile Strength: 6000 lb., Weight Capacity: 310 lbs. (140 kg)

AB17530



ITEM #	ORDER #	DESCRIPTION	UOM
AB17530	458075301	Blue and Black, Size Universal	EA
AB17550	458036081	Blue and Black, Size XLarge	EA



Compliance in a Can™ Roofer's Fall Protection Kits

- » OSHA 1910.66, OSHA 1926.502, Weight Capacity: 310 lbs. (140 kg)
- » Reusable and extremely durable roof anchor with fasteners (model 2104000)
- » Lightweight FIRST™ harness with pass-thru buckle legs and 5-point adjustment (model 1191995)
- » Compact rope adjuster with built-in 2 ft. (0.6 m) PRO™ shock absorbing lanyard (model 1340005)
- » Durable and lightweight 0.625" Dia. (1.6 cm) 50 ft. (15.2 m) blended lifeline with snap hook (model 1204001)
- » Durable bucket with handle



2199803

ITEM #	ORDER #	DESCRIPTION	UOM
2199803	458098031	Compliance Version	EA



Harnesses



650CN-BDP/UGN

Honeywell
MILLER

Contractor Harnesses

- » Combination back D-ring pad/shoulder pads
- » Friction buckle shoulder adjustments
- » Mating buckle chest adjustments
- » Tongue buckle legs adjustments
- » Back lumbar pad, (2) pull-free lanyard rings
- » Waist belt (removable) for tool pouches
- » Meets applicable OSHA, ANSI and CSA Standards
- » Weight Capacity: 400 lbs. (181.4 kg)

ITEM #	ORDER #	DESCRIPTION	UOM
With Back and Side D-Rings			
650CN-BDP/UGN	341579911	Universal Size, (L, XL)	EA
With Back D-Rings			
650CN-BP/UGN	341558481	Universal Size, (L, XL)	EA

Honeywell
MILLER

Lightweight/Comfort Welder Harness

- » Features blue, flame-retardant Nomex® webbing to protect against weld splatter
- » Inner Kevlar® core adds strength and high-temperature resistance
- » Friction buckle shoulder adjustments
- » Mating buckle chest and leg straps
- » Meets applicable OSHA, ANSI and CSA Standards
- » Rated to 400 lbs. (181.4 kg) capacity when using a SofStop shock absorber (940K/6FTBL)

ITEM #	ORDER #	DESCRIPTION	UOM
650K/UBL	341558471	Universal Size, (L, XL)	EA



650K/UBL



E650/UGN

Honeywell
MILLER

DuraFlex® Harness

- » Specially-formulated elastomer webbing that stretches to provide greater comfort
- » D-ring back pad for comfort
- » Self-contained label pack encapsulates labels
- » Integrated and oversized pull-free lanyard rings
- » Friction buckle shoulder adjustments
- » Mating buckle leg straps
- » Meets applicable OSHA, ANSI and CSA Standards
- » Rated to 400 lbs. (181.4 kg) capacity, 6,000 lb. tensile strength

ITEM #	ORDER #	DESCRIPTION	UOM
E650/UGN	341559051	Universal Size, (L, XL)	EA



Harnesses



Honeywell MILLER®

Revolution™ Harnesses with DualTech™ Webbing

- » Web finials - clip-on design safely organizes webbing after proper adjustment
- » PivotLink™ connection - rotary design provides greater mobility
- » ErgoArmor back shield - minimizes impact from snap hooks and lifelines
- » Cam Buckles - one-hand adjustment/release for shoulder straps
- » Side D-rings and pad
- » Quick-connect buckle legs, removable belt
- » Accessory System - provides connection points for belts/tools/accessories
- » Self-contained label pack
- » Meets applicable OSHA, ANSI and CSA Standards
- » Rated to 400 lbs. (181.4 kg) capacity, 7,000 lb. tensile strength

ITEM #	ORDER #	DESCRIPTION	UOM
RDT-QC/UBK	341504611	Universal Size, (L, XL)	EA

Honeywell MILLER®

Titan™ II Non-Stretch Harnesses

- » Easier vertical adjustability, slip resistant back D-ring pad
- » Lighter, strategically-placed padding that provides optimal airflow
- » Lightweight, Hi-Viz color webbing and ANSI Z359.11 compliance
- » Meets applicable OSHA, ANSI and CSA Standards
- » Rated to 400 lbs. (181.4 kg) capacity
- » Universal Size (Large/XLarge)

ITEM #	ORDER #	DESCRIPTION	UOM
T2000/UAK	341590011	With Sliding Back D-Ring; Mating Buckle Chest and Legs	EA
T4000/UAK	341541571	With Sliding Back D-Ring; Mating Buckle Legs, Chest and Shoulder Straps; Sub-Pelvic Strap	EA
T4007/UAK	341506431	With Sliding Back D-Ring; Side D-Rings, Mating Buckle Legs, Chest and Shoulder Straps; Sub-Pelvic Strap	EA
T4007FD/UAK	341541591	With Sliding Back D-Ring; Front D-Ring, Side D-Rings, Mating Buckle Legs, Chest and Shoulder Straps; Sub-Pelvic Strap	EA
T4500/UAK	341506461	With Sliding Back D-Ring; Tongue Buckle Legs, Mating Buckle Chest and Shoulder Straps; Sub-Pelvic Strap	EA
T4507/UAK	341506471	With Sliding Back D-Ring; Side D-Rings; Tongue Buckle Legs, Mating Buckle Chest and Shoulder Straps; Sub-Pelvic Strap	EA
T4577/UAK	341506481	With Sliding Back D-Ring; Tongue Buckle Legs, Mating Buckle Chest; Friction Buckle Shoulder Straps; Side D-Rings; Shoulder/Waist Padding and Removable Belt	EA





Harnesses



Titan™ II T-Flex™ Stretchable Harnesses

- » Stretchable harnesses have a durable, stretch webbing construction for improved mobility
- » Easier vertical adjustability, slip resistant back D-ring pad
- » Lighter, strategically-placed padding that provides optimal airflow
- » Lightweight, Hi-Viz color webbing and ANSI Z359.11 compliance
- » Meets applicable OSHA, ANSI and CSA Standards
- » Rated to 400 lbs. (181.4 kg) capacity
- » Universal Size (Large/XLarge)



ITEM #	ORDER #	DESCRIPTION	UOM
TF4000/UAK	341505621	With Sliding Back D-Ring; Mating Buckle Legs, Chest and Shoulder Straps; Sub-Pelvic Strap	EA
TF4007/UAK	341505631	With Sliding Back D-Ring; Side D's, Mating Buckle Legs, Chest and Shoulder Straps; Sub-Pelvic Strap	EA
TF4500/UAK	341505641	With Sliding Back D-Ring; Tongue Buckle Legs, Mating Buckle Chest and Shoulder Straps; Sub-Pelvic Strap	EA
TF4507/UAK	341505651	With Sliding Back D-Ring; Side D's; Tongue Buckle Legs, Mating Buckle Chest and Shoulder Straps; Sub-Pelvic Strap	EA



V-FORM™ Safety Harness

- » The patent-pending RaceFORM buckle allows for a close comfortable full body harness fit - eliminating the need for a bulky chest strap
- » Athletic cut that contours to the body and allows for increased upper torso mobility
- » Pull-down adjustment allows for quick and easy harness adjustment that ensures a proper fit that lasts throughout the work day
- » Meets applicable ANSI Z359.11-2014 and CSA Z259.10-2018 Standards

ITEM #	ORDER #	DESCRIPTION	UOM
10197196	308518351	Standard Size, Back D-Ring, Qwik-Fit Leg Straps	EA
10196642	308517081	Standard Size, Back D-Ring, Tongue Buckle Leg Straps	EA
10197160	308517091	Extra Large Size, Back D-Ring, Tongue Buckle Leg Straps	EA



Workman® Arc Flash Harnesses

- » Nylon material won't melt or drip in the event of an arc flash
- » Y-shaped D-locator pad keeps torso straps off the user's neck
- » Velcro lanyard keepers for stowage when not in use
- » Arc Flash symbol for easy identification
- » Meets applicable OSHA 1910.66, OSHA 1926.502, OSHA Z359.1-2007, ANSI Z359.11-2014, ASTM F887-2013 and CSA Z259.10 Standards

ITEM #	ORDER #	DESCRIPTION	UOM
10152637	308526391	Standard Size, with BACK STEEL D-Ring and Tongue Buckle Leg Straps	EA
10152652	308526551	Standard Size, with BACK STEEL D-Ring and Qwik-Fit leg Straps	EA



Harnesses



Gravity® Harness

- » Abrasion and moisture resistant and is suitable for working in harsh environments
- » Uses a special urethane web coating to resist stains and wear and tear
- » Suitable for controlled descent, positioning, ladder climbing, rescue and fall arrest
- » Includes load-indicator alert if harness was involved in a fall event
- » Meets ANSI Z359.1, OSHA standards and is CSA certified
- » Rated 400 lbs. (180 kg) capacity



ITEM #	ORDER #	DESCRIPTION	UOM
10155875	308504711	Standard Size, Yellow Vest-Type, with BACK & HIP D-Rings and Tongue Buckle Leg Straps	EA

Hoist System



Advanced™ 5-Piece Hoist System

- » Aluminum construction, 5-piece davit hoist system
- » Integrated 5,000 lb. (22 kN) mast anchorage point
- » Fall arrest rated in all davit offset mast positions
- » Built-in primary and secondary pulleys
- » Adjustable vertical height of 33" to 43"
- » Detent and knob style adjustment
- » Combine up to 2 extensions, extends the davit mast height
- » Base width adjusts from 94 cm to 162.6 cm, foot level and height adjustment system
- » ANSI Z359.1, OSHA 1926.502
- » Weight capacity: 450 lbs. (204 kg)

ITEM #	ORDER #	DESCRIPTION	UOM
8518000	458068271	Green and Silver	EA



IN-2404



10158178



Workman® Rescuer

- » User capacity up to 400 lbs. for personnel
- » Integral mounting bracket, stainless steel carrying handle
- » Color-coded switch for retrieval, built-in shock absorber
- » Aluminum housing with thermoplastic bumpers
- » Self-locking swivel snap hook with load indicator
- » Stow-able, foldable crank handle
- » RFID-enabled
- » Meets all applicable OSHA regulations, ANSI Z359.14

ITEM #	ORDER #	DESCRIPTION	UOM
10158178	308504721	With 0.1875" Stainless Steel Cable, 50 Ft. (15 m)	EA

Accessory

IN-2404	308504731	Mounting Bracket	EA
---------	-----------	------------------	----



Trauma Strap



Trauma Strap

- » Allows the fallen worker to assume a standing position and relieve pressure on the lower extremities
- » Allows better blood flow and reduces fatigue
- » Easy to adjust
- » Low profile keeps it out of the way during work
- » Nylon, Polyester and steel
- » Worker Capacity: 420 lbs.



10733

ITEM #	ORDER #	DESCRIPTION	UOM
10733	K62400291	Trauma Strap	EA

Positioning Device



01600



24" Rebar Chain Assembly

- » Lightweight and durable
- » Perfect for work positioning
- » Double legs allow workers to lean away from walls, while keeping their hands free to perform any necessary work
- » Galvanized steel and rebar
- » Non-Swivel Steel Snap Hooks
- » Capacity: 130-310 lbs.

ITEM #	ORDER #	DESCRIPTION	UOM
01600	K62400431	Swivel Rebar Hook Chain Assembly	EA

Lanyards



11200



01220



6' Internal Shock Lanyard w/ Steel Snap Hook

- » Heavy duty outer polyester webbing
- » Shock absorption is built directly into the lanyard
- » Single Leg
- » Steel Snap Hook
- » Capacity: 130-310 lbs.

ITEM #	ORDER #	DESCRIPTION	UOM
11200	K62400191	Internal Shock Lanyard	EA



6' External Shock Lanyard

- » 1" Nylon web
- » Clear shock pack for easy inspection
- » 3,600 lb. connector gate
- » Single Leg
- » Steel Snap Hook
- » Nylon, Polyester and galvanized steel
- » Meets all the stringent ANSI Z359.13-2013 regulations
- » Capacity: 130-310 lbs.

ITEM #	ORDER #	DESCRIPTION	UOM
01220	K62400461	External Shock Lanyard	EA



Lanyards



ShockWave2™ Shock-Absorbing Lanyards

- » 6 ft. (1.8 m) yellow lanyard
- » Stretches in reaction to your movements
- » Abrasion resistant polyester tubular webbing
- » Energy absorbing design limits fall arrest forces
- » Built-in impact indicator
- » Protected labels, equipped with i-Safe™
- » Weight capacity: 130-310 lbs. (59-141 kg)
- » ANSI A10.32, ANSI Z359.1, ANSI Z359.13, OSHA 1910.66, OSHA 1926.502

ITEM #	ORDER #	DESCRIPTION	UOM
1244306	458020121	Single Leg w/ Snap Hooks on Both Ends	EA
1244321	458035081	Single Leg w/ Snap Hook at One End, Steel Rebar Hook at Other End	EA
1244412	458020141	Double-Leg 100% Tie-Off w/ Snap Hook at Center, Steel Rebar Hooks at Leg Ends	EA



EZ-STOP™ Retrax™ Lanyards

- » 2.5 ft. – 6 ft. retractable single leg yellow lanyard
- » Retraction keeps lanyard taut and close to body
- » Adjustable retraction length
- » Arresting forces to 900 lbs. or less
- » 1.375" wide polyester webbing
- » Impact indicator, equipped with i-Safe™
- » Weight Capacity: 130-310 lbs. (59-141 kg)
- » OSHA 1910.66, OSHA 1926.502

ITEM #	ORDER #	DESCRIPTION	UOM
1241460	458014611	2.5 Ft.-6 Ft. Single Leg Lanyard w/ Snap Hooks Both Ends	EA



PRO™ Shock-Absorbing Lanyards

- » 6 ft. (1.8 m) red double-leg 100% tie-off lanyard
- » PVC shock pack with protected label
- » Abrasion resistant polyester webbing
- » Self-locking snap hook at center
- » Self-locking steel rebar hook at leg ends
- » Built-in impact indicator
- » Weight Capacity: 130-310 lbs. (59-141 kg)
- » ANSI A10.32, OSHA 1910.66, OSHA 1926.502

ITEM #	ORDER #	DESCRIPTION	UOM
1340180	458001801	6 Ft. (1.8 m) Double-Leg 100% Tie-Off Lanyard	EA



EZ-STOP™ II Shock-Absorbing Lanyards

- » 6 ft. (1.8 m) yellow lanyard
- » Exclusive Hi-10™ Vectran™ energy absorption system
- » Repel™ webbing
- » Self-locking snap hooks at each end
- » Built-in impact indicator
- » Protected labels, equipped with i-Safe™
- » Weight Capacity: 130-310 lbs. (59-141 kg)
- » ANSI A10.32, ANSI Z2359.13, OSHA 1910.66, OSHA 1926.502

ITEM #	ORDER #	DESCRIPTION	UOM
1246011	458060111	Single-Leg with Snap Hooks at Each End	EA
1246022	458060221	Double-Leg 100% Tie-Off with Snap Hooks at Each End	EA



Lanyards

Honeywell
MILLER

Manyard® II Stretchable Shock-Absorbing Lanyards

- » 6 ft. (1.8 m) retractable single leg green lanyard
- » Shock-absorbing inner core smoothly expands out
- » Tubular outer jacket serves as a back-up lanyard
- » Built-in impact indicator
- » ANSI Z359 Compliant



219M-Z7/6FTGN

ITEM #	ORDER #	DESCRIPTION	UOM
216M-Z7/6FTGN	341558431	6 Ft. Single Leg; (2) Locking Snap Hooks	EA
219M-Z7/6FTGN	341558421	6 Ft. Single Leg; (1) Locking Snap Hook and (1) 2.5 in. Locking Rebar Hook	EA

Honeywell
MILLER

BackBiter® Tie-Back Lanyards

- » All-in-one lanyard with SofStop® shock absorber and cross-arm anchorage connector
- » 5,000 lb. (Miller 5K®) (22kN) gate load capacity from any angle, steel 0.625" (16 mm) locking snap hook
- » Steel, 0.75" (19 mm) locking snap hook gate opening
- » Weight Capacity: 310 lbs. (141 kg)
- » OSHA, CSA and ANSI Z359-2007 compliant

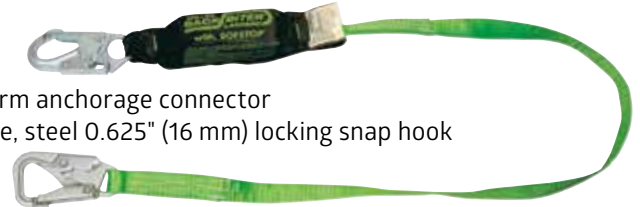

913B/6FTGN

ITEM #	ORDER #	DESCRIPTION	UOM
8798B/6FTGN	341552001	6 Ft. Double Leg, (1) 0.75" Locking Snap Hook and (2) 0.625" (5K®) Snap Hooks, Green	EA
913B/6FTGN	341543671	6 Ft. Single Leg, (1) 0.75" Locking Snap Hook and (1) 0.625" (5K®) Snap Hooks, Green	EA

Honeywell
MILLER

Titan™ II Tubular Shock-Absorbing Lanyards

- » Built-in woven inner core expands reducing fall arrest forces
- » Outer jacket serves as a back-up web lanyard
- » Built-in impact indicator
- » Locking Snap Hooks: 0.75" (19 mm) opening
- » Locking Rebar Hooks: 2.5" (63 mm) opening
- » Weight Capacity: 310 lbs. (141 kg)
- » Meets all OSHA 1926.502, ANSI A10.32, ANSI Z359.13 and CSA Z259.11-05, Class B and E4 requirements



T5122-Z7/6FTAF

ITEM #	ORDER #	DESCRIPTION	UOM
T5111-Z7/6FTAF	341566801	6 Ft. Single Leg; (2) Locking Snap Hooks, Orange	EA
T5112-Z7/6FTAF	341567021	6 Ft. Single Leg; Locking Snap Hook and Large Locking Rebar Hook, Orange	EA
T5121-Z7/6FTAF	341566781	6 Ft. Double Leg; (3) Locking Snap Hooks, Orange	EA
T5122-Z7/6FTAF	341567531	6 Ft. Double Leg; Locking Snap Hook and (2) Large Locking Rebar Hooks, Orange	EA



Lanyards

Honeywell MILLER

Titan™ II Positioning and Restraint Lanyards

- » Web lanyards are recommended for “work positioning” and “restraint” only
- » 1 in. wide orange polyester webbing
- » Locking Snap Hook: 0.75" (19 mm) opening
- » Tensile Strength: 5000 lbs., Weight Capacity: 310 lbs. (141 kg)
- » Meets ANSI Z359-2007, CSA, OSHA standards



T9111W-Z7/6FTAF

ITEM #	ORDER #	DESCRIPTION	UOM
T9111W-Z7/6FTAF	341573291	6 Ft. Web Lanyard with (2) Locking Snap Hooks	EA

Honeywell MILLER

Titan™ II Pack-Type Shock-Absorbing Lanyards

- » Includes the SofStop® shock-absorber pack as an integral part of a standard lanyard
- » In a fall, the pack expands, reducing fall forces while a back-up safety strap deploys protection
- » Built-in impact indicator
- » Locking Snap Hook: 0.75" (19 mm) opening
- » Locking Rebar Hook: 2.25" (57 mm) opening
- » Weight Capacity: 310 lbs. (141 kg)
- » Meets all OSHA 1926.502, ANSI A10.32, ANSI Z359.13 and CSA Z259.11-05, Class B and E4 requirements



T6122-Z7/6FTAF

ITEM #	ORDER #	DESCRIPTION	UOM
T6111-Z7/6FTAF	341567201	6 Ft. Single Leg; (2) Locking Snap Hooks, Orange	EA
T6121-Z7/6FTAF	341567461	6 Ft. Double Leg; (2) Locking Snap Hooks, Orange	EA
T6122-Z7/6FTAF	341567931	6 Ft. Double Leg; (1) Locking Snap Hook and (2) Locking Rebar Hooks, Orange	EA

Honeywell MILLER

Titan™ II Tie-Back Lanyard

- » Pack-type shock absorber is designed for tie-back use
- » Eliminates the need for a separate anchorage connector
- » 9800 lbs. (4445 kg) webbing for abrasion resistance
- » Auto-locking carabiner
- » Locking snap hook for connecting to the harness back D-ring
- » Weight Capacity: 310 lbs. (141 kg)
- » Meets OSHA, ANSI, and CSA standards



T6121TB-Z7/6FTAF

ITEM #	ORDER #	DESCRIPTION	UOM
T6121TB-Z7/6FTAF	341573251	6 Ft. Double Leg; (2) Adjustable D-Rings, (2) Twist Lock Carabiners at Anchor End	EA



Lanyards



Workman® Self-Retracting Lanyard

- » Self-retracting lifeline
- » Black and yellow thermoplastic housing with impact-absorbing bumpers
- » 0.75" 36CS swivel snap hook with load indicator
- » 400 lbs. (136 kg) working capacity
- » RFID-enabled
- » Certified to OSHA, ANSI Z359.14 2012 and CSA Z259.2.2 standards

ITEM #	ORDER #	DESCRIPTION	UOM
10119507	3085377E1	30 Ft. Cable, 0.1875 In. Dia. Steel Cable	EA



10119507



62710-00US



Latchways Leading Edge Retractable Lanyard

- » Self-retracting lifeline
- » Approved for leading, sharp edge and overhead use
- » Stainless steel chassis and components
- » 310 lbs. worker capacity
- » Certified to OSHA and ANSI Z359.14 (LE) standards

ITEM #	ORDER #	DESCRIPTION	UOM
62710-00US	308511061	33 Ft. (10 m) Cable, 36CSN Snap Hook, Steel Carabiner (Top), Yellow	EA



Lifelines



11' Halo Web SRL w/ Steel Snap Hook

- » Designed with a specialized quick-action braking system
- » Manufactured from non-corrosive, lightweight components
- » Extremely durable and compact
- » Galvanized steel, polyester and nylon
- » Swivel top
- » Capacity: 130-310 lbs.



10900

ITEM #	ORDER #	DESCRIPTION	UOM
10900	K62400261	SRL w/ Steel Snap Hook	EA



30' Halo Web SRL w/ Steel Snap Hook

- » Designed with a specialized quick-action braking system
- » Manufactured from non-corrosive, lightweight components
- » Extremely durable and compact
- » Swivel top
- » Galvanized cable
- » Capacity: 130-310 lbs.



10915

ITEM #	ORDER #	DESCRIPTION	UOM
10915	K62400251	SRL w/ Steel Snap Hook	EA



30' Halo Cable SRL-LE

- » Designed specifically for Leading Edge (LE) work
- » Carabiner included
- » Integrated shock absorbing component
- » Galvanized steel lifeline
- » Steel Snap Hook
- » Swivel top
- » Boot cover



10925

ITEM #	ORDER #	DESCRIPTION	UOM
10925	K62400241	SRL w/ Steel Snap Hook	EA

1202754



Rope Lifeline Assemblies

- » 0.625" (16 mm) Dia. polyester/polypropylene blend
- » Built-in self-locking snap hook at one end
- » Durable, high strength 5-tuck splice
- » Equipped with i-Safe™
- » Weight Capacity: 310 lbs. (141 kg)
- » Meets ANSI A10.32, ANSI Z359.1, OSHA 1910.66, OSHA 1926.502 requirements/standards

ITEM #	ORDER #	DESCRIPTION	UOM
1202754	458027541	30 Ft. (9 m) Long	EA
1202794	458035071	50 Ft. (15 m) Long	EA



Rescue Pole

- » Allows assisted rescue of worker after a fall
- » Use with Self-Rescue detachable descent device
- » Extension pole adjusts from 2.16 ft. to 8.66 ft.
- » Aluminum connection hook with tagline
- » Fast and efficient rescues take just minutes
- » Compact and lightweight design

ITEM #	ORDER #	DESCRIPTION	UOM
8900299	458002581	Black, with Storage Bag	EA



8900299



Lifelines



Sealed-Blok™ Self-Retracting Lifeline

- » Environmentally sealed dynamic components
- » FAST-Line™ cable lifeline replacement system
- » Anti-ratcheting locking system
- » Built-in carrying handle, swiveling snap hook with impact indicator
- » Large pivoting anchorage loop, Saflok™ anchorage carabiner
- » Cable tie-off adaptor x 4 ft. (1.2 m) with carabiner
- » Reserve lifeline system, cable handle equipped with i-Safe™
- » Weight Capacity: 420 lbs. (190 kg)
- » Meets ANSI A10.32, ANSI Z359.1, ANSI Z359.14, OSHA 1910.66, OSHA 1926.502 requirements/standards



3400900

ITEM #	ORDER #	DESCRIPTION	UOM
3400900	458020441	50 Ft. (15 m) 0.1875" (5 mm) Galvanized Steel Cable Lifeline	EA



Nano-Lok™ Edge Self-Retracting Lifeline

- » Twin-leg 100% tie-off design for foot-level tie-off and sharp edge applications
- » Built-in connector for twin-leg SRL direct attachment to harness
- » 0.1875" (5 mm) galvanized steel cable
- » Thermoplastic housing
- » Steel rebar lock hooks on each lifeline, swiveling anchorage loops
- » Quick activating speed sensing brake systems
- » i-Safe™ equipped
- » Weight Capacity: 310 lbs. (141 kg)
- » Meets ANSI A10.32, ANSI Z359.14, OSHA 1910.66, OSHA 1926.502 requirements/standards



3500227

ITEM #	ORDER #	DESCRIPTION	UOM
3500227	458012361	8 Ft. (2.4 m) Twin-Leg Lifeline, Orange	EA



Ultra-Lok™ Self-Retracting Lifeline for Retrieval

- » 3-way emergency retrieval system
- » Integrated quick-connect mounting bracket
- » Stowable retrieval handle
- » Thermoplastic housing, stainless steel components
- » Internal energy absorption system
- » Anti-ratcheting twin disk brake system
- » Built-in carrying handle
- » Swiveling anchorage point and snap hook with impact indicator
- » Reserve lifeline system
- » Cable handle equipped with i-Safe™
- » Weight Capacity: 310 lbs. (141 kg)
- » Meets ANSI A10.32, ANSI Z359.1, ANSI Z359.14, OSHA 1910.66, OSHA 1926.502 requirements/standards



3501102

ITEM #	ORDER #	DESCRIPTION	UOM
3501102	458011081	50 Ft. (15.2 m) 0.1875" (5 mm) Galvanized Steel Cable Lifeline	EA



Lifelines



Ultra-Lok™ Cable Self-Retracting Lifelines

- » Semi-sealed design
- » 0.1875" (5 mm) galvanized steel cable lifeline
- » Thermoplastic housing, stainless steel components
- » Internal energy absorption system
- » Anti-ratcheting twin disk brake system
- » Built-in carrying handle
- » Swiveling anchorage point and snap hook with impact indicator
- » Reserve lifeline system
- » Cable handle equipped with i-Safe™
- » Weight Capacity: 310 lbs. (141 kg)
- » Meets ANSI A10.32, ANSI Z359.1, ANSI Z359.14, OSHA 1910.66, OSHA 1926.502 requirements/standards



3504430

ITEM #	ORDER #	DESCRIPTION	UOM
3504430	458020201	30 Ft. (9.1 m) Long Cable	EA
3504433	45804433	20 Ft. (6.1 m) Long Cable	EA
3504450	458044501	50 Ft. (15.2 m) Long Cable	EA



Lad-Saf™ Mobile Rope Grab

- » Mobile rope grab for use on 0.625" (16 mm) rope lifeline
- » Inertia and cam locking systems for safety
- » Design is less sensitive to rope variations
- » Corrosion resistant construction
- » Use with 3 ft. (0.9 m) shock absorbing lanyard
- » Weight Capacity: 310 lbs. (141 kg)
- » Meets ANSI A10.32, ANSI Z359.1, OSHA 1926.502 requirements/standards



5000335

ITEM #	ORDER #	DESCRIPTION	UOM
5000335	458020211	Rope Grab	EA



6160054



Lad-Saf™ Flexible Cable Ladder Safety System

- » For use on 0.375" (9.5 mm) 1 x 7 or 7 x 19 solid core cable
- » Easy to install and detach anywhere along lifeline
- » Dual independent locking system
- » Built-in energy absorber and fall indicator with swivel
- » Saflok™ steel carabiner for secure connection to harness
- » Corrosion resistant construction
- » Integrated RFID tag, equipped with i-Safe™
- » Weight Capacity: 310 lbs. (141 kg)
- » Meets ANSI A14.3-1992 requirements/standards

ITEM #	ORDER #	DESCRIPTION	UOM
6160054	458000561	Ladder Safety System	EA



Lifelines



EZ-Line™ Retractable Horizontal Lifeline System

- » 60 ft. (18.3 m) retractable system can be set at any length
- » Rugged 0.25" (6.3 mm) 7 x 19 galvanized cable
- » Built-in winch, pre-tension and impact indicators
- » Internal energy absorber limits fall arrest forces
- » Use with any 5,000 lb. (22.2 kN) anchorage device
- » Equipped with i-Safe™
- » Weight Capacity: 310 lbs. (141 kg)
- » Meets OSHA 1926.502 requirements/standards



7605060

ITEM #	ORDER #	DESCRIPTION	UOM
7605060	458020231	Lifeline System	EA



Suspension Trauma Safety Straps

- » Allows user to stand in harness after a fall
- » Attaches to almost any harness
- » Compact and lightweight
- » Simple and fast zipper style deployment
- » Continuous loop
- » In-field re-settable
- » Weight Capacity: 310 lbs. (141 kg)



9501403

ITEM #	ORDER #	DESCRIPTION	UOM
9501403	458020251	Safety Straps	PR



Self-Rescue 50/100/Trainer

- » Universal harness attachment
- » EZ-Link™ D-ring for fast connections
- » Assisted-rescue ring for incapacitated user
- » Sealed descent device and rope spool
- » Molded padding
- » Equipped with i-Safe™
- » Weight Capacity: 130-310 lbs. (59-141 kg)
- » Meets ANSI Z359.4, OSHA 1926.502 requirements/standards



3320030

ITEM #	ORDER #	DESCRIPTION	UOM
3320030	458002521	50 Ft. of 5.5 mm, 12 Strand Braided Technora® Rope	EA
3320031	458002351	100 Ft. of 5.5 mm, 12 Strand Braided Technora® Rope	EA
Self-Rescue Trainer Allows up to 20 Descents			
3320037	458002541	30 Ft. of 5.5 mm, 12 Strand Braided Technora® Rope	EA



Lifelines



3100425



Rebel™ Self-Retracting Lifelines

- » Self-locking, swiveling anchorage loop and carabiner
- » Self-locking snap hook on lifeline
- » Stackable thermoplastic housing
- » Speed sensing brake system
- » External energy absorber and impact indicator
- » Weight Capacity: 310 lbs. (141 kg)
- » Meets ANSI A10.32, ANSI Z359.1, ANSI Z359.14, OSHA 1910.66, OSHA 1926.502 requirements/standards

ITEM #	ORDER #	DESCRIPTION	UOM
1" (2.5 cm) Polyester Webbing			
3100425	458004251	11 Ft. Long	EA
3100431	458004311	20 Ft. Long	EA
0.1875" (5 mm) Galvanized Steel Wire			
3590019	458090191	15 Ft. Long with Kevlar®/Nomex® Covered Energy Absorber and Impact Indicator	EA



Rebel™ Self-Retracting Cable Lifelines

- » Stackable thermoplastic housing
- » Built-in carrying handle
- » 0.1875" (5 mm) galvanized steel wire
- » Swiveling self-locking snap hook with impact indicator
- » Speed sensing brake system
- » Internal energy absorption system
- » Reserve lifeline system
- » Swiveling anchorage point
- » Self-locking anchorage carabiner
- » Weight Capacity: 420 lbs. (190 kg)
- » Meets ANSI A10.32, ANSI Z359.1, ANSI Z359.14, OSHA 1910.66, OSHA 1926.502 requirements/standards



3590500

ITEM #	ORDER #	DESCRIPTION	UOM
3590500	458005001	33 Ft. Long Cable	EA
3590550	45800550	50 Ft. Long Cable	EA

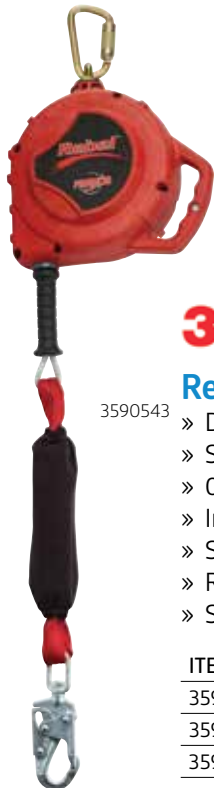

3590543



Rebel™ Self-Retracting Lifeline - Leading Edge

- » Designed for leading edge applications
- » Stackable housing design, thermoplastic housing
- » 0.21875" (5.5 mm) galvanized steel cable lifeline
- » Internal and external energy absorption systems
- » Swiveling self-locking snap hook with impact indicator
- » Reserve lifeline system, side exit
- » Swiveling anchorage point, built-in carrying handle
- » Self-locking anchorage carabiner
- » Weight Capacity: 310 lbs. (141 kg)
- » ANSI A10.32, ANSI Z359.1, ANSI Z359.14, OSHA 1910.66, OSHA 1926.502

ITEM #	ORDER #	DESCRIPTION	UOM
3590543	458034741	33 Ft. Long Cable	EA
3590546	458005971	50 Ft. (15.2 m) Cable	EA
3590548	458005981	66 Ft. (20.1 m) Cable	EA



Lifelines



MightyLite™ Self-Retracting Lifelines

- » Durable and dependable, corrosion-resistant stainless steel and aluminum housing
- » Double-swivel design preventing the lifeline from twisting or kinking
- » Steel twist-lock carabiner and tagline included for attaching to an anchorage
- » Quick-activating inertia brakes, integral load indicator
- » Meets OSHA, ANSI, CSA Z259.2.2 Type 2 and CE requirements

ITEM #	ORDER #	DESCRIPTION	UOM
RL20G-Z7/20FT	341558331	SRL with 20 Ft. (6 m) - 0.1875" (5 mm) Galvanized Wire Rope	EA



RL20G-Z7/20FT



SSRL50G1



DuraSeal™ Self-Retracting Lifelines

- » Patent-pending Miller DuraSeal™ Self-Retracting Lifeline (SRL) is designed to perform in the harshest environments
- » Highest industry rated sealed technology IP69K
- » Built to last reusable brake design withstands multiple falls
- » Enables, quicker easier installation and provides protection from rain
- » Quick, low cost repair is achieved with field

ITEM #	ORDER #	DESCRIPTION	UOM
SSRL50G1	341573691	SRL with Cable Sling, Tagline and 2 Carabiners with 50 Ft. Galvanized Steel Cable	EA

Manhole Guard Systems



XTIRPA™ Manhole Guard System

IN-2108 – Manhole Guard System

- Integrated mast 42", adjustable feet
- Used in conjunction with 24" davit arm (IN-2210)
- Extremely lightweight, easily portable
- Unit weight: 29 lbs., 42"H x 38"W x 38"D
- Meets OSHA regulations

IN-2210 – 24" Davit Arm

- Arm with secondary winch adapter for fall protection
- Used in conjunction with 42" mast (IN-2108)
- Equipped with 5,000 lb. anchor point
- Unit weight: 33 lbs., 67"L x 9"W x 8"H
- Capacity 360 lbs., meets or exceeds ANSI, CSA, OSHA & CE

ITEM #	ORDER #	DESCRIPTION	UOM
IN-2108	308503731	Manhole Guard System	EA
IN-2210	308503721	Davit Arm	EA

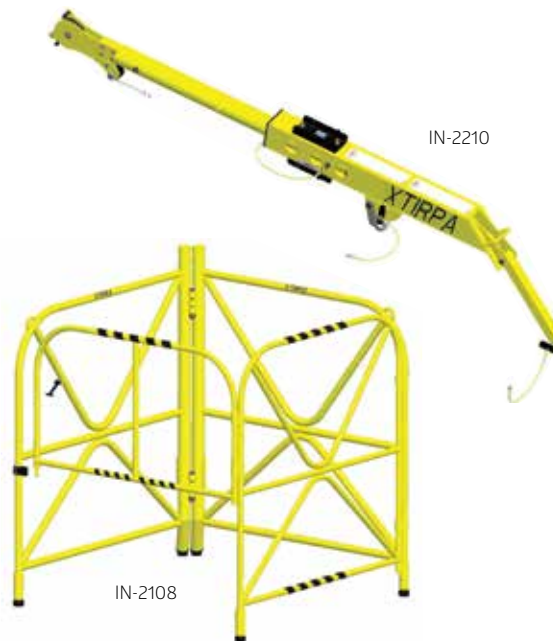

IN-2210

IN-2108

Accessories



I0200RG-00-000

Rescue Mate™ Rescue Bags

- » 1000-denier Cordura® bag holds 3/8" braided, floating polypropylene rope
- » Rope supports up to 1,800 lbs. of tensile pressure
- » Orange bag with quick-release carrying strap
- » 1" reflective tape around the bag for visibility



ITEM #	ORDER #	DESCRIPTION	UOM
I0200RG-00-000	623903621	Bag with 50 ft. of Rope	EA
I0210RG-00-000	623903631	Bag with 70 ft. of Rope	EA



I0230RG-00-000

Ring Buoy Type IV and Rope Bag

- » 30" (77 cm) industrial-grade ring buoy
- » Constructed of high-impact, low-density orange polyethylene
- » Replaceable encircling rope for added gripping
- » I030 Type IV Ring Buoy - USCG Approval



I0300RG-00-REF



ITEM #	ORDER #	DESCRIPTION	UOM
I0300RG-00-REF	623903861	30 in. Ring Buoy	EA
90 ft. of 3/8" Polypropylene Floating Rope and Bag, Attaches to Ring Buoy			
I0230RG-00-000	623903781	Rope and Bag	EA

Flotation Vests/Jackets



2000013834

Force™ II Life Vests

- » US Coast Guard-approved, USCG Type V Vest
- » Aquafoam™ flotation foam retains buoyancy, even when punctured
- » 3M™ Scotchlite™ SOLAS-grade reflective strips on the front and back
- » Compatible with most fall protection harnesses
- » Self-extinguishing construction reduces fire risks
- » 17.5 lbs. (78 Newtons) of buoyancy

ITEM #	ORDER #	DESCRIPTION	UOM
2000013834	623900431	Size: Universal	EA
2000015183	623905231	Size: Oversize	EA



3000003509

Inflatable Work Vest

- » USCG Approved Work Vest
- » Puncture resistant outer shell, tri-fold for easy repacking
- » 31.5 sq in. of reflective tape
- » Fall protection harness opening in back
- » Automatic Inflator with clear viewing window
- » Provides a minimum of 35 lbs. of buoyancy when fully inflated

ITEM #	ORDER #	DESCRIPTION	UOM
3000003509	623935091	Size: Universal	EA



Flotation Vests/Jackets



2000011404

First Mate™ Life Vests

- » US Coast Guard-approved, USCG Type III vest
- » Four hook-and-loop pockets and two sturdy D-rings to hang gear
- » Contoured design and side-adjustment tabs
- » 3M™ Scotchlite™ Reflective Material SOLAS-grade 6755 panel patches
- » Minimum 15.5 lbs. (69 Newtons) buoyancy

ITEM #	ORDER #	DESCRIPTION	UOM
2000011404	623900291	Size Medium	EA
2000011405	623900301	Size XLarge	EA
2000011406	623900311	Size 2XLarge	EA
2000011407	623900321	Size 3XLarge	EA
2000011408	623900331	Size 4XLarge	EA



I416ORG-04-000F

Deck Hand II™ Life Vests

- » Breathable marine mesh lining wicks away moisture
- » 3M™ Scotchlite™ SOLAS-grade reflective strips
- » Heavy-duty encircling belt, rustproof Vision® Zipper and chest pocket
- » 15.5 lbs. (69 Newtons) of buoyancy
- » US Coast Guard-approved, 29-02 Type III PFD

ITEM #	ORDER #	DESCRIPTION	UOM
I416ORG-03-000F	623900111	Size Medium	EA
I416ORG-04-000F	623900121	Size Large	EA
I416ORG-05-000F	623900131	Size XLarge	EA
I416ORG-06-000F	623900141	Size 2XLarge	EA
I416ORG-07-000F	623900151	Size 3XLarge	EA
I416ORG-08-000F	623900161	Size 4XLarge-7XLarge	EA



2000011389

General Purpose Vests

- » US Coast Guard-approved, USCG Type III Vest
- » Two encircling body belts and one chest strap
- » Durable Crosstech® flotation foam
- » 200 Denier nylon oxford outershell
- » 3M™ Scotchlite™ Reflective Material SOLAS-grade 6755 on panels

ITEM #	ORDER #	DESCRIPTION	UOM
2000011389	623900281	Size: Universal	EA



I405ORG-00-000F

Welders Vest

- » US Coast Guard-approved, USCG Type III vest
- » Fiberglass shell suitable for marine welding
- » Breathable marine mesh lining wicks away moisture
- » Oversized armholes, adjustable sides and rustproof Vision® zipper
- » Aquafoam™ Flotation Foam retains buoyancy even when punctured
- » 15.5 lbs. (69 Newtons) of buoyancy

ITEM #	ORDER #	DESCRIPTION	UOM
I405ORG-00-000F	623900091	Size: Universal	EA

Flotation Vests/Jackets



2000011434

I624 Deck Hand™ Vests

- » US Coast Guard-approved Type III
- » Tough nylon oxford outershell and lightweight Crosstech® Flotation Foam
- » Breathable mesh lining wicks away excess moisture
- » 3M™ Scotchlite™ SOLAS-grade reflective strips improve visibility
- » Heavy-duty encircling belt with side adjustments and a rustproof Vision® zipper
- » 15.5 lbs. (69 Newtons) of buoyancy

ITEM #	ORDER #	DESCRIPTION	UOM
2000011433	623900631	Size Medium	EA
2000011434	623900641	Size Large	EA
2000011435	623900651	Size XLarge	EA
2000011436	623900661	Size 2XLarge	EA
2000011437	623900671	Size 3XLarge	EA



2000011417

I426 Search and Rescue (SAR) Vests

- » US Coast Guard-approved life jacket - Type III
- » Two 1.5" encircling belts, adjustable chest strap and zippered front
- » Two pockets with hook-and-loop tape closures
- » Rolled, stand-up collar
- » Minimum 15.5 lbs. (69 Newtons) buoyancy
- » 66 sq. in. of 3M™ Scotchlite™ SOLAS grade 6755 reflective material

ITEM #	ORDER #	DESCRIPTION	UOM
2000011416	623900571	Size Medium	EA
2000011417	623900581	Size Large	EA
2000011418	623900591	Size XLarge	EA
2000011419	623900601	Size 2XLarge	EA
2000011420	623900611	Size 3XLarge	EA



2000004522

Deluxe Merchant Mate™ II Life Vest

- » US Coast Guard-approved, USCG Type I vest
- » Foam-filled collar, two chest adjusters change the flotation angle to turn most unconscious wearers face up
- » Back panel accommodates most fall protection harnesses
- » 3M™ Scotchlite™ SOLAS-grade reflective strips
- » Shoulder mount flashlight patch, pocket and included USCG-approved whistle
- » 22 lbs. (98 Newtons) of buoyancy

ITEM #	ORDER #	DESCRIPTION	UOM
2000004522	623900051	Universal Size	EA



2000004520

Work Master™ Vests

- » US Coast Guard-approved Type III/V performance
- » Closed-cell foam, marine mesh liner and hinged back
- » Body belt with strap tunnels, quick-adjustment slides and easy-snap buckles
- » Flotation collar keeps swimmer's head able to look for help
- » 62 sq. in. (400 sq. cm) of 3M™ Scotchlite™ Reflective Material SOLAS-grade 6755 on panels
- » Durable webbed 1" (2.54 cm) straps, nylon shell and PVC flotation foam
- » 17.5 lbs. (78 Newton) buoyancy

ITEM #	ORDER #	DESCRIPTION	UOM
2000004520	623900401	Size: Universal	EA
2000004521	623900411	Size: Oversize	EA



Flotation Vests/Jackets



Work Zone Gear™ Life Vests

- » US Coast Guard-approved Type III
- » 3M™ Scotchlite™ Reflective Material SOLAS-grade 6187 on panels
- » Crosstech® flotation foam and polyester outer shell construction
- » Two body straps, zippered front for fit
- » Large arm holes and low necklines
- » D-ring for gear, two pockets with hook-and-loop tape closures
- » Minimum 15.5 lbs. (69 Newtons) buoyancy



2000011357



I424ORG-04-ANS



300001119

ITEM #	ORDER #	DESCRIPTION	UOM
--------	---------	-------------	-----

Orange Vest with 3M™ Scotchlite™ Reflective Shoulder Panels

2000011410	623900451	Size Medium	EA
2000011357	623900461	Size Large	EA
2000011412	623900471	Size XLarge	EA
2000011413	623900481	Size 2XLarge	EA
2000011414	623900491	Size 3XLarge	EA

ANSI Hi-Viz Orange Vest with HiViz Yellow 3M™ Scotchlite™ Reflective Stripping

I424ORG-03-ANS	623900511	Size Medium	EA
I424ORG-04-ANS	623900521	Size Large	EA
I424ORG-05-ANS	623900531	Size XLarge	EA
I424ORG-06-ANS	623900541	Size 2XLarge	EA
I424ORG-07-ANS	623900551	Size 3XLarge	EA

ANSI Hi-Viz Green Vest with Silver 3M™ Scotchlite™ Reflective Stripping

300001118	623911181	Size Medium	EA
300001119	623911191	Size Large	EA
300001120	623911201	Size XLarge	EA
300001121	623911221	Size 2XLarge	EA
300001123	623911231	Size 3XLarge	EA



Type III Search and Rescue (SAR) Vest

- » US Coast Guard-approved life jacket - Type III
- » Attached leg strap, emergency whistle and light loop for flashlight
- » Fleece-lined pockets heat cold fingers and zippered storage compartments for gear
- » 2-in.-wide (5.08 cm) adjustable belts and chest strap
- » 62 sq. in. (400 sq. cm) of 3M™ Scotchlite™ Reflective Material SOLAS-grade 6755 on panels
- » 15.5-lb (69-Newton) buoyancy



4185ORG-04-000

ITEM #	ORDER #	DESCRIPTION	UOM
4185ORG-03-000	623902621	Orange, Size Small	EA
4185ORG-04-000	623902631	Orange, Size Large	EA
4185ORG-05-000	623902641	Orange, Size XLarge	EA
4185ORG-06-000	623902651	Orange, Size 2XLarge	EA
4185ORG-07-000	623902661	Orange, Size 3XLarge	EA
4185ORG-08-000	623902671	Orange, Size 4XLarge	EA



Flotation Vests/Jackets

Versatile™ Vests

- » US Coast Guard-approved Type III performance
- » Four hook-and-loop pockets, two D-rings and eyelets to attach equipment
- » 3M™ Scotchlite™ Reflective Material SOLAS-grade 6755 on panels for visibility
- » Durable nylon shell, marine mesh lining and PVC flotation foam construction
- » 15.5 lbs. (69 Newtons) buoyancy

ITEM #	ORDER #	DESCRIPTION	UOM
I4650RG-03-000F	623900351	Size Medium	EA
I4650RG-04-000F	623900361	Size Large	EA
I4650RG-05-000F	623900371	Size XLarge	EA
I4650RG-06-000F	623900381	Size 2XLarge	EA
I4650RG-07-000F	623900391	Size 3XLarge	EA



I4650RG-04-000F



2000005011

1470 Ultra Commercial-Automatic Vests

- » US Coast Guard-approved life jacket - Type V/II (Auto) or Type V/III (Manual)
- » Auto inflation when submerged in water, manual inflation by pulling lanyard or by oral tube
- » Pocket for extra cylinder and D-ring for attaching gear
- » 3M™ Scotchlite™ SOLAS-grade 6755 reflective material
- » 33.7 lbs. of buoyancy, 33-gram CO₂ cylinder

ITEM #	ORDER #	DESCRIPTION	UOM
2000005011	623901671	Orange, Size: Universal	EA
2000005012	623901661	Black, Size: Universal	EA



2000004041

Ultra 4000 Convertible-Automatic Vests

- » US Coast Guard-approved - Type V/II (Auto) / Type V/III (Manual)
- » Convertible from automatic to manual-only inflation
- » 2-in. adjustable belt, D-ring and cylinder storage pocket
- » Reflective accents make you easier to see
- » Patented L-Tab™ webbing catch secures excess belt length
- » 33.7 lbs. of buoyancy

ITEM #	ORDER #	DESCRIPTION	UOM
2000004041	623901651	Black, Size: Universal	EA



Neoprene Cold Water Gloves

- » 2 mm neoprene gloves specially-glued and blind-stitched
- » Rugged shark skin palm

ITEM #	ORDER #	DESCRIPTION	UOM
5600BLK-03-000	623903661	Black, Size Medium	PR
5600BLK-04-000	623903671	Black, Size Large	PR
5600BLK-05-000	623903681	Black, Size XLarge	PR

Hand Protection



5600BLK-04-000

Accessories



2000027422

Ice Rescue Suit

- » Constructed of 5 mm flame retardant neoprene
- » 100% Closed Cell Neoprene
- » 3M Scotchlite Reflective Material SOLAS grade
- » Hood with offset zipper
- » Waterproof zipper
- » Five-Fingered Insulated gloves with textured palms
- » Stainless Steel Hardware on lifting harness
- » Adjustable Wrists w/wrist pockets for ice picks
- » Thick soled boot with tread for sure footing
- » Not intended for prolonged immersion, recommended for surface rescue only.

ITEM #	ORDER #	DESCRIPTION	UOM
2000027421	623905671	Size: Small, Up to 250 lbs. Max Height: 5 ft. 8 in. (173 cm)	EA
2000027422	623905681	Size: Universal, 110-330 lbs. Max Height: 6 ft. 3 in. (191 cm)	EA
2000027423	623901701	Size: Oversize, 220-330 lbs. Max Height: 6 ft. 9 in. (205 cm)	EA



Rapid Rescue Extreme™ Surface Dry Suits

- » Made with extra-breathable nylon laminated, waterproof fabric
- » Internal suspenders that keep the suit in place
- » Latex and neoprene seals around the neck and wrists keep moisture out and you dry
- » Reinforced Cordura® fabric knees and elbows offer added durability
- » Quick-access entry zipper and built-in waterproof socks make for rapid dressing
- » Reflective markings for added visibility
- » Padded polyurethane reinforced knees

ITEM #	ORDER #	DESCRIPTION	UOM
2000023957	623905591	Red/Black, Size Medium	EA
2000023958	623905521	Red/Black, Size Large	EA
2000023959	623905341	Red/Black, Size XLarge	EA
2000023960	623905601	Red/Black, Size XXLarge	EA



1810-04-000



2000008113



SOLAS Cold Water Immersion Suits

- » 5 mm, stretchable, flame-retardant neoprene for protection from hypothermia
- » Five-fingered integrated gloves, face shields and inflatable neck support
- » Immersion suit pocket and SOLAS-approved whistle
- » 3M™ Scotchlite™ Reflective Material SOLAS-grade 3150-A PS
- » Stainless steel lifting harness and buddy line with snap hook
- » Durable, non-slip soles
- » USCG Certificate of Approval, Module B with Head Support (Type S)

ITEM #	ORDER #	DESCRIPTION	UOM
2000008113	623981131	Red/Black, Size: Adult Universal	EA
2000008114	623981141	Red/Black, Size: Adult Oversize	EA



Disposable

DuPont™ ProShield® 10 Coveralls

- » Designed for workers in a range of industries for non-hazardous dry particle and light liquid splash applications
- » Spunbond-Meltblown-Spunbond (SMS) garments, are optimized for comfort, softness and breathability
- » Uses include general maintenance, janitorial/cleaning and other dirty work
- » Serged seams, front zipper closure and storm flap

ITEM #	ORDER #	DESCRIPTION	UOM
Collar, Open Wrists and Ankles			
PB120SBUMD002500	31712500	Blue, Medium	25/Cs
PB120SBULG002500	31712501	Blue, Large	25/Cs
PB120SBUXL002500	31712502	Blue, XLarge	25/Cs
PB120SBU2X002500	31712503	Blue, 2XLarge	25/Cs
PB120SBU3X002500	31712504	Blue, 3XLarge	25/Cs
PB120SBU4X002500	31712505	Blue, 4XLarge	25/Cs
PB120SWHMD002500	31712510	White, Medium	25/Cs
PB120SWHLG002500	31712511	White, Large	25/Cs
PB120SWHXL002500	31712512	White, XLarge	25/Cs
PB120SWH2X002500	31712513	White, 2XLarge	25/Cs
PB120SWH3X002500	31712514	White, 3XLarge	25/Cs
PB120SWH4X002500	31712515	White, 4XLarge	25/Cs
Attached Hood and Boots, Elastic Wrists			
PB122SBUMD002500	31712520	Blue, Medium	25/Cs
PB122SBULG002500	31712521	Blue, Large	25/Cs
PB122SBUXL002500	31712522	Blue, XLarge	25/Cs
PB122SBU2X002500	31712523	Blue, 2XLarge	25/Cs
PB122SBU3X002500	31712524	Blue, 3XLarge	25/Cs
PB122SBU4X002500	31712525	Blue, 4XLarge	25/Cs
PB122SWHMD002500	31712530	White, Medium	25/Cs
PB122SWHLG002500	31712531	White, Large	25/Cs
PB122SWHXL002500	31712532	White, XLarge	25/Cs
PB122SWH2X002500	31712533	White, 2XLarge	25/Cs
PB122SWH3X002500	31712534	White, 3XLarge	25/Cs
PB122SWH4X002500	31712535	White, 4XLarge	25/Cs
Collar, Elastic Wrists and Ankles			
PB125SBUMD002500	31712540	Blue, Medium	25/Cs
PB125SBULG002500	31712541	Blue, Large	25/Cs
PB125SBUXL002500	31712542	Blue, XLarge	25/Cs
PB125SBU2X002500	31712543	Blue, 2XLarge	25/Cs
PB125SBU3X002500	31712544	Blue, 3XLarge	25/Cs
PB125SBU4X002500	31712545	Blue, 4XLarge	25/Cs
PB125SWHMD002500	31712550	White, Medium	25/Cs
PB125SWHLG002500	31712551	White, Large	25/Cs
PB125SWHXL002500	31712552	White, XLarge	25/Cs
PB125SWH2X002500	31712553	White, 2XLarge	25/Cs
PB125SWH3X002500	31712554	White, 3XLarge	25/Cs
PB125SWH4X002500	31712555	White, 4XLarge	25/Cs
Attached Hood, Elastic Wrists and Ankles			
PB127SBUMD002500	31712560	Blue, Medium	25/Cs
PB127SBULG002500	31712561	Blue, Large	25/Cs
PB127SBUXL002500	31712562	Blue, XLarge	25/Cs
PB127SBU2X002500	31712563	Blue, 2XLarge	25/Cs
PB127SBU3X002500	31712564	Blue, 3XLarge	25/Cs
PB127SBU4X002500	31712565	Blue, 4XLarge	25/Cs
PB127SWHMD002500	31712570	White, Medium	25/Cs
PB127SWHLG002500	31712571	White, Large	25/Cs
PB127SWHXL002500	31712572	White, XLarge	25/Cs
PB127SWH2X002500	31712573	White, 2XLarge	25/Cs
PB127SWH3X002500	31712574	White, 3XLarge	25/Cs
PB127SWH4X002500	31712575	White, 4XLarge	25/Cs



PB120SBULG002500



PB122SBU2X002500



PB125SWHMD002500



PB127SWHXL002500



Disposable



DuPont™ ProShield® 50 Coveralls

- » Provides a barrier against a range of non-hazardous aerosols, light liquid splash and dry particles
- » Made with a microporous film that is laminated to a spunbonded polypropylene substrate
- » Uses include janitorial, sanitation, general industrial and maintenance
- » Serged seams and front zipper closure

ITEM #	ORDER #	DESCRIPTION	UOM
Collar, Open Wrists and Ankles			
NB120SWHSM002500	31710111	White, Small	25/Cs
NB120SWHMD002500	31710113	White, Medium	25/Cs
NB120SWHLG002500	31710114	White, Large	25/Cs
NB120SWHXL002500	31710119	White, XLarge	25/Cs
NB120SWH2X002500	31710122	White, 2XLarge	25/Cs
NB120SWH3X002500	31710123	White, 3XLarge	25/Cs
NB120SWH4X002500	31710149	White, 4XLarge	25/Cs

Attached Hood and Boots, Elastic Wrists

NB122SWHSM002500	31710150	White, Small	25/Cs
NB122SWHMD002500	31710151	White, Medium	25/Cs
NB122SWHLG002500	31710152	White, Large	25/Cs
NB122SWHXL002500	31710157	White, XLarge	25/Cs
NB122SWH2X002500	31710072	White, 2XLarge	25/Cs
NB122SWH3X002500	31710073	White, 3XLarge	25/Cs
NB122SWH4X002500	31710074	White, 4XLarge	25/Cs

Collar, Elastic Wrists and Ankles

NB125SWHSM002500	31710075	White, Small	25/Cs
NB125SWHMD002500	31710076	White, Medium	25/Cs
NB125SWHLG002500	31710077	White, Large	25/Cs
NB125SWHXL002500	31710079	White, XLarge	25/Cs
NB125SWH2X002500	31710080	White, 2XLarge	25/Cs
NB125SWH3X002500	31710161	White, 3XLarge	25/Cs
NB125SWH4X002500	31710162	White, 4XLarge	25/Cs

Attached Hood, Elastic Wrists and Ankles

NB127SWHSM002500	31710177	White, Small	25/Cs
NB127SWHMD002500	31710178	White, Medium	25/Cs
NB127SWHLG002500	31710180	White, Large	25/Cs
NB127SWHXL002500	31710181	White, XLarge	25/Cs
NB127SWH2X002500	31710182	White, 2XLarge	25/Cs
NB127SWH3X002500	31710183	White, 3XLarge	25/Cs
NB127SWH4X002500	31710185	White, 4XLarge	25/Cs



NB122SWHLG002500



NB125SWHXL002500



Disposable



DuPont™ ProShield® 60 Coveralls

- » Provides a barrier against a range of non-hazardous aerosols, light liquid splash and dry particles
- » Made with a microporous film that is laminated to a spundbonded polypropylene substrate
- » Applications include: automotive refinishing, waste cleanup and remediation
- » Serged seams and front zipper closure

ITEM #	ORDER #	DESCRIPTION	UOM
Collar, Open Wrists and Ankles			
NG120S-L	31710125	White, Large	25/Cs
NG120S-XL	31710128	White, XLarge	25/Cs
NG120S-2XL	31710129	White, 2XLarge	25/Cs
NG120S-3XL	31710130	White, 3XLarge	25/Cs
NG120S-4XL	31710131	White, 4XLarge	25/Cs

Attached Hood and Boots, Elastic Wrists			
NG122S-M	31710135	White, Medium	25/Cs
NG122S-L	31710134	White, Large	25/Cs
NG122S-XL	31710136	White, XLarge	25/Cs
NG122S-2XL	31710137	White, 2XLarge	25/Cs
NG122S-3XL	31710138	White, 3XLarge	25/Cs
NG122S-4XL	31710139	White, 4XLarge	25/Cs
NG122S-5XL	31710140	White, 5XLarge	25/Cs

Collar, Elastic Wrists and Ankles			
NG125S-M	31710635	White, Medium	25/Cs
NG125S-L	31710141	White, Large	25/Cs
NG125S-XL	31710142	White, XLarge	25/Cs
NG125S-2XL	31710143	White, 2XLarge	25/Cs
NG125S-3XL	31710144	White, 3XLarge	25/Cs
NG125S-4XL	31710145	White, 4XLarge	25/Cs
NG125S-5XL	31710146	White, 5XLarge	25/Cs

Storm Flap, Respirator-Fit Hood, Elastic Face, Wrists and Ankles			
NG127S-M	31716146	White, Medium	25/Cs
NG127S-L	31716147	White, Large	25/Cs
NG127S-XL	31716148	White, XLarge	25/Cs
NG127S-2XL	31716149	White, 2XLarge	25/Cs
NG127S-3XL	31716150	White, 3XLarge	25/Cs
NG127S-4XL	31716151	White, 4XLarge	25/Cs



NG122S-2XL



NG125S-2XL



Disposable



TM122S-2XL



QC122S-XL



DuPont™ ProShield® 6 SFR Coveralls

- » Lightweight, disposable overgarment designed to help protect and preserve primary flame-resistant garments
- » Provides a barrier against non-hazardous particles and aerosols while not contributing to burn injury
- » Applications include: steel mills, coal mines, maintenance work, refineries, laboratories, utilities
- » Serged seams and front zipper closure

ITEM #	ORDER #	DESCRIPTION	UOM
Collar, Open Wrists and Ankles			
TM120S-L	31712975	Blue, Large	25/Cs
TM120S-XL	31712978	Blue, XLarge	25/Cs
TM120S-2XL	31712979	Blue, 2XLarge	25/Cs
TM120S-3XL	31712980	Blue, 3XLarge	25/Cs
TM120S-4XL	31713965	Blue, 4XLarge	25/Cs
TM120S-5XL	31714029	Blue, 5XLarge	25/Cs
Attached Hood and Socks, Elastic Wrists			
TM122S-L	31713564	Blue, Large	25/Cs
TM122S-XL	31713761	Blue, XLarge	25/Cs
TM122S-2XL	31714082	Blue, 2XLarge	25/Cs
TM122S-3XL	31711122	Blue, 3XLarge	25/Cs
TM122S-4XL	31711123	Blue, 4XLarge	25/Cs
TM122S-5XL	31712509	Blue, 5XLarge	25/Cs
Attached Hood, Elastic Wrists and Ankles			
TM127S-L	31712985	Blue, Large	25/Cs
TM127S-XL	31712988	Blue, XLarge	25/Cs
TM127S-2XL	31712989	Blue, 2XLarge	25/Cs
TM127S-3XL	31712990	Blue, 3XLarge	25/Cs
TM127S-4XL	31710457	Blue, 4XLarge	25/Cs
TM127S-5XL	31714038	Blue, 5XLarge	25/Cs



DuPont™ Tychem® 2000 Coveralls

- » Light liquid splash protection is polyethylene-coated Tyvek® fabric
- » Use in the petroleum, pulp and paper, food and chemical processing and pharmaceutical industries
- » Meets ASTM F1670 and ASTM F1671 tests, offering bloodborne pathogen protection
- » Front zipper closure and storm flap with tape closure

ITEM #	ORDER #	DESCRIPTION	UOM
Collar, Open Wrists and Ankles			
QC120B-L	31710295	Bound, Large	12/Cs
QC120B-XL	31710298	Bound, XLarge	12/Cs
QC120B-2XL	31710299	Bound, 2XLarge	12/Cs
QC120B-3XL	31710300	Bound, 3XLarge	12/Cs
QC120B-4XL	31710323	Bound, 4XLarge	12/Cs
Attached Hood and Socks, Elastic Wrists and Face			
QC122S-L	31710314	Serged, Large	12/Cs
QC122S-XL	31710317	Serged, XLarge	12/Cs
QC122S-2XL	31710318	Serged, 2XLarge	12/Cs
QC122S-3XL	31710319	Serged, 3XLarge	12/Cs
Collar, Front Storm Flap, Elastic Wrists and Ankles			
QC125B-L	31710321	Bound, Large	12/Cs
QC125B-XL	31710324	Bound, XLarge	12/Cs
QC125B-2XL	31710325	Bound, 2XLarge	12/Cs
QC125B-3XL	31710326	Bound, 3XLarge	12/Cs
QC125B-4XL	31710327	Bound, 4XLarge	12/Cs
QC125S-L	31710329	Serged, Large	12/Cs
QC125S-XL	31710332	Serged, XLarge	12/Cs
QC125S-2XL	31710333	Serged, 2XLarge	12/Cs
QC125S-3XL	31710334	Serged, 3XLarge	12/Cs
QC125S-4XL	31710335	Serged, 4XLarge	12/Cs
Attached Hood, Elastic Face, Wrists and Ankles			
QC127S-M	31710346	Serged, Medium	12/Cs
QC127S-L	31710345	Serged, Large	12/Cs
QC127S-XL	31710348	Serged, XLarge	12/Cs
QC127S-2XL	31710349	Serged, 2XLarge	12/Cs
QC127S-3XL	31710350	Serged, 3XLarge	12/Cs
QC127S-4XL	31710351	Serged, 4XLarge	12/Cs
QC127S-5XL	31710352	Serged, 5XLarge	12/Cs



Disposable



DuPont™ Tychem® 6000 Coveralls

- » Made of a proprietary barrier film laminated to a Tyvek® substrate
- » Provides at least 30 min. of protection against >180 chemical challenges
- » Used by military personnel and first responders for chemical warfare agent situation
- » Taped seams, attached hood (respirator fit) and front zipper closure
- » Storm flap with tape closure, elastic wrists and attached socks



TF145T-L

ITEM #	ORDER #	DESCRIPTION	UOM
TF145T-M	31710728	Gray, Medium	6/Cs
TF145T-L	31710727	Gray, Large	6/Cs
TF145T-XL	31710729	Gray, XLarge	6/Cs
TF145T-2XL	31710730	Gray, 2XLarge	6/Cs
TF145T-3XL	31710731	Gray, 3XLarge	6/Cs
TF145T-4XL	31710732	Gray, 4XLarge	6/Cs



DuPont™ Tyvek® 400 Coveralls

- » An ideal balance of protection, durability and comfort
- » Breathable inherent Tyvek® 400 fabric barrier protection against hazardous dry particles, aerosols and non-hazardous light liquid splash
- » Applications include: lead and asbestos abatement/remediation, general maintenance/operations, spray painting, general clean-up
- » Front zipper closure with storm flap
- » Serged seams and elastic waist



TY127S-XL

ITEM #	ORDER #	DESCRIPTION	UOM
Collar, Open Wrists and Ankles			
TY120S-M	31710459	White, Medium	25/Cs
TY120S-L	31710458	White, Large	25/Cs
TY120S-XL	31710461	White, XLarge	25/Cs
TY120S-2XL	31710462	White, 2XLarge	25/Cs
TY120S-3XL	31710463	White, 3XLarge	25/Cs
TY120S-4XL	31710464	White, 4XLarge	25/Cs

Attached Hood and Boots, Elastic Wrists and Ankles

TY122S-M	31710467	White, Medium	25/Cs
TY122S-L	31710466	White, Large	25/Cs
TY122S-XL	31710469	White, XLarge	25/Cs
TY122S-2XL	31710470	White, 2XLarge	25/Cs
TY122S-3XL	31710471	White, 3XLarge	25/Cs
TY122S-4XL	31710472	White, 4XLarge	25/Cs

Collar, Elastic Wrists and Ankles

TY125S-M	31710476	White, Medium	25/Cs
TY125S-L	31710475	White, Large	25/Cs
TY125S-XL	31710478	White, XLarge	25/Cs
TY125S-2XL	31710479	White, 2XLarge	25/Cs
TY125S-3XL	31710480	White, 3XLarge	25/Cs
TY125S-4XL	31710481	White, 4XLarge	25/Cs

Attached Hood, Elastic Wrists and Ankles

TY127S-M	31710485	White, Medium	25/Cs
TY127S-L	31710484	White, Large	25/Cs
TY127S-XL	31710487	White, XLarge	25/Cs
TY127S-2XL	31710488	White, 2XLarge	25/Cs
TY127S-3XL	31710489	White, 3XLarge	25/Cs
TY127S-4XL	31710490	White, 4XLarge	25/Cs



Disposable



DuPont™ Tychem® 4000 Coveralls

- » Tychem® 4000 is Saranex™ 23-P film laminated to Tyvek® fabric
- » Rugged and durable, uses include waste management, hazardous response and nuclear environments
- » Meets ASTM F1670 and ASTM F1671 tests, offering bloodborne pathogen protection
- » Front zipper closure and storm flap with tape closure



SL122B-2XL

ITEM #	ORDER #	DESCRIPTION	UOM
Collar, Open Wrists and Ankles			
SL120B-L	31710378	White, Bound, Large	12/Cs
SL120B-XL	31710381	White, Bound, XLarge	12/Cs
SL120B-2XL	31710382	White, Bound, 2XLarge	12/Cs
SL120B-3XL	31710383	White, Bound, 3XLarge	12/Cs
SL120B-4XL	31710384	White, Bound, 4XLarge	12/Cs
Attached Hood and Socks, Elastic Face and Wrists			
SL122B-XL	31710389	White, Bound, XLarge	12/Cs
SL122B-2XL	31710390	White, Bound, 2XLarge	12/Cs
SL122B-3XL	31710391	White, Bound, 3XLarge	12/Cs
Collar, Elastic Wrists and Ankles			
SL125T-L	31712378	White, Taped, Large	6/Cs
SL125T-XL	31710699	White, Taped, XLarge	6/Cs
SL125T-2XL	31712382	White, Taped, 2XLarge	6/Cs
SL125T-3XL	31713529	White, Taped, 3XLarge	6/Cs
SL125T-4XL	31713314	White, Taped, 4XLarge	6/Cs
SL125B-L	31710399	White, Bound, Large	6/Cs
SL125B-XL	31710402	White, Bound, XLarge	6/Cs
SL125B-2XL	31710403	White, Bound, 2XLarge	6/Cs
SL125B-3XL	31710404	White, Bound, 3XLarge	6/Cs
SL125B-4XL	31710405	White, Bound, 4XLarge	6/Cs



QC273BYL00010000



DuPont™ Tychem® 2000 Aprons

- » Light liquid splash protection is yellow polyethylene-coated Tyvek® fabric
- » Use in the petroleum, pulp and paper, food and chemical processing and pharmaceutical industries
- » Meets ASTM F1670 and ASTM F1671 tests, offering bloodborne pathogen protection
- » Bound neck and ties, bib style

ITEM #	ORDER #	DESCRIPTION	UOM
QC273BYL00010000	31714084	28" x 36" Long, Yellow	100/Cs



DuPont™ Tyvek® 400 Apron

- » Breathable inherent Tyvek® 400 fabric barrier protection against hazardous dry particles, aerosols and non-hazardous light liquid splash
- » Applications include: lead and asbestos abatement/remediation, general maintenance/operations, spray painting, general clean-up
- » Bibb style, provides enhanced frontal protection
- » Bound seams around neck, ties at waist

ITEM #	ORDER #	DESCRIPTION	UOM
TY273BWH00010000	31710784	28" x 36" Long, White	100/Cs



TY273BWH00010000



Disposable



DuPont™ Tyvek® 400 Frocks

- » Breathable inherent Tyvek® 400 fabric barrier protection against hazardous dry particles, aerosols and non-hazardous light liquid splash
- » Applications include: lead and asbestos abatement/remediation, general maintenance/operations, spray painting, general clean-up
- » Body-length jacket design with front snap closures
- » Serged seams and elastic waist
- » No pockets



TY210S-XL

ITEM #	ORDER #	DESCRIPTION	UOM
Open Wrists			
TY210S-M	31710494	White, Medium	30/Cs
TY210S-L	31710493	White, Large	30/Cs
TY210S-XL	31710496	White, XLarge	30/Cs
TY210S-2XL	31710497	White, 2XLarge	30/Cs
TY210S-3XL	31710498	White, 3XLarge	30/Cs
TY210S-4XL	31710499	White, 4XLarge	30/Cs

ITEM #	ORDER #	DESCRIPTION	UOM
Elastic Wrists, Extra Long			
TY211S-M	31710502	White, Medium	30/Cs
TY211S-L	31710501	White, Large	30/Cs
TY211S-XL	31710504	White, XLarge	30/Cs
TY211S-2XL	31710505	White, 2XLarge	30/Cs
TY211S-3XL	31710506	White, 3XLarge	30/Cs
TY211S-4XL	31713282	White, 4XLarge	30/Cs
TY211S-5XL	31713266	White, 5XLarge	30/Cs



TY212SWHLG003000



DuPont™ Tyvek® 400 Lab Coats

- » Breathable inherent Tyvek® 400 fabric barrier protection against hazardous dry particles, aerosols and non-hazardous light liquid splash
- » Applications include: lead and asbestos abatement/remediation, general maintenance/operations, spray painting, general clean-up
- » Coat extends below hip with collar and front snap closures
- » Serged seams
- » Two front pockets

ITEM #	ORDER #	DESCRIPTION	UOM
TY212SWHMD003000	31710508	White, Medium	30/Cs
TY212SWHLG003000	31710507	White, Large	30/Cs
TY212SWHXL003000	31710510	White, XLarge	30/Cs
TY212SWH2X003000	31710511	White, 2XLarge	30/Cs
TY212SWH3X003000	31710512	White, 3XLarge	30/Cs



DuPont™ Tyvek® 400 Pants

- » Breathable inherent Tyvek® 400 fabric barrier protection against hazardous dry particles, aerosols and non-hazardous light liquid splash
- » Applications include: lead and asbestos abatement/remediation, general maintenance/operations, spray painting, general clean-up
- » Open ankles and elastic waist
- » Serged seams



TY350SWHLG005000

ITEM #	ORDER #	DESCRIPTION	UOM
TY350SWHMD005000	31710528	White, Medium	50/Cs
TY350SWHLG005000	31710527	White, Large	50/Cs
TY350SWHXL005000	31710530	White, XLarge	50/Cs
TY350SWH2X005000	31710531	White, 2XLarge	50/Cs



Disposable



DuPont™ Tyvek® 400 Shirts

- » Breathable inherent Tyvek® 400 fabric barrier protection against hazardous dry particles, aerosols and non-hazardous light liquid splash
- » Applications include: lead and asbestos abatement/remediation, general maintenance/operations, spray painting, general clean-up
- » Shirt with laydown collar and front snap closure
- » Long sleeve with open wrists

ITEM #	ORDER #	DESCRIPTION	UOM
TY303S-M	31710521	White, Medium	50/Cs
TY303S-L	31710520	White, Large	50/Cs
TY303S-XL	31710523	White, XLarge	50/Cs
TY303S-2XL	31710524	White, 2XLarge	50/Cs
TY303S-3XL	31710525	White, 3XLarge	50/Cs
TY303S-4XL	31710526	White, 4XLarge	50/Cs



TY303S-XL



TY657S



DuPont™ Tyvek® 400 Hood

- » DuPont™ Tyvek® 5.4 mil white hood with serged seams and elastic around face opening
- » Good fit around PAPR and extends over shoulders to offer full head protection
- » Used in lead and asbestos abatement/remediation, general maintenance/operations, spray-painting and general clean-up applications

ITEM #	ORDER #	DESCRIPTION	UOM
TY657S	31710539	White, Universal Size	100/Cs



DuPont™ ProShield® 30 Shoe and Boot Covers

- » Unique polyethylene extrusion coating for skid resistance
- » Tear-resistant fabric with seamless bottom
- » Fluid-resistant for safety and extended life
- » Virtually lint-free, will not delaminate
- » Generous cut



PE440SWHLG020000

ITEM #	ORDER #	DESCRIPTION	UOM
Shoe Covers, Skid-Resistant			
PE440SBULG020000	31711669	Blue, Large	100 Pr/Cs
PE440SBUXL020000	31711670	Blue, XLarge	100 Pr/Cs
PE440SWHLG020000	31710217	White, Large	100 Pr/Cs
PE440SWHXL020000	31710218	White, XLarge	100 Pr/Cs
Boot Covers, 13" High			
PE444SWHLG010000	31716622	13" High, White, Large	50 Pr/Cs
PE444SWHXL010000	31714441	13" High, White, XLarge	50 Pr/Cs



Disposable



DuPont™ Tyvek® 400 FC Boot and Shoe Covers

- » Tyvek® FC - Friction Coated - fabric
- » Serged seams
- » Elastic opening
- » Skid resistant



FC450SGY00020000



FC454SGY00010000

ITEM #	ORDER #	DESCRIPTION	UOM
FC454SGY00010000	31714100	18" High, Boot Covers	100/Cs
FC450SGY00020000	31713961	5" High, Shoe Covers	100/Cs



TY454SWH00010000



DuPont™ Tyvek® 400 Boot Covers

- » Breathable inherent Tyvek® 400 fabric barrier protection against hazardous dry particles, aerosols and non-hazardous light liquid splash
- » Applications include: lead and asbestos abatement/remediation, general maintenance/operations, spray painting, general clean-up
- » Serged seams and elastic opening

ITEM #	ORDER #	DESCRIPTION	UOM
TY454SWH00010000	31718090	18" High, One Size Fits Most	100/Cs
Skid Resistant FC Sole and Elastic Ankle			
TY454SWHLG0100SR	31714075	18" High, Large	100/Cs
TY454SWHXL0100SR	31714065	18" High, XLarge	100/Cs



DuPont™ Tyvek® 400 Shoe Covers

- » Breathable inherent Tyvek® 400 fabric barrier protection against hazardous dry particles, aerosols and non-hazardous light liquid splash
- » Applications include: lead and asbestos abatement/remediation, general maintenance/operations, spray painting, general clean-up
- » Serged seams and elastic opening



TY450SWH00020000

ITEM #	ORDER #	DESCRIPTION	UOM
TY450SWH00020000	31713959	5" High, One Size Fits Most	200/Cs
TY450SWH000200LG	31714083	8.25" High, One Size Fits Most	200/Cs



Disposable



58503



Kleenguard* A20 Breathable Particle Protection Coveralls

- » Protect against dirt, grime and dust
- » Made with breathable Microforce barrier fabric
- » Zipper front with 1" flap, elastic back, wrists and ankles
- » Passes NFPA 99 for antistatic materials
- » Meets the EPA Agricultural (WPS) requirements for "coveralls"

ITEM #	ORDER #	DESCRIPTION	UOM
White Coveralls			
49102	15408246	White, Medium	24/Cs
49103	15408248	White, Large	24/Cs
49104	15408250	White, XLarge	24/Cs
49105	15408244	White, 2XLarge	24/Cs
49106	15408245	White, 3XLarge	20/Cs
49107	15404910	White, 4XLarge	20/Cs

ITEM #	ORDER #	DESCRIPTION	UOM
Blue Coveralls			
58503	15408503	Blue, Large	24/Cs
58504	15400279	Blue, XLarge	24/Cs
58505	15408505	Blue, 2XLarge	24/Cs
58506	15408506	Blue, 3XLarge	20/Cs



Kleenguard* A10 Light-Duty Shoe Covers

- » Protect against dirt, grime and dust
- » Made with lightweight polypropylene breathable barrier fabric
- » Fully elasticized, have serged seams and are "low skid"
- » Meets ANSI/ISEA 101-1996 sizing standards

ITEM #	ORDER #	DESCRIPTION	UOM
36811	15406811	Blue, Size Universal	300/Cs



Kleenguard* A10 Light-Duty Aprons

43744



- » Protect against dirt, grime and dust
- » Coated with polyethylene and made of lightweight, breathable material
- » Serged seams, ties and do not have pockets

ITEM #	ORDER #	DESCRIPTION	UOM
43744	15400293	28" x 36", White	100/Cs



Kleenguard* A10 Light-Duty Coveralls

10468



- » Protect against dirt, grime and dust
- » Zipper front, elastic wrists and serged seams
- » Fabric is five layers of stacked barrier protection (SMMMS)
- » Meets ANSI/ISEA 101-1996 sizing standards

ITEM #	ORDER #	DESCRIPTION	UOM
10468	15401114	White, Large	25/Cs
10636	15401111	White, XLarge	25/Cs



36811



Disposable



46104



Kleenguard* A30 Breathable Splash and Particle Protection Coveralls

- » Protect against dirt, grime and light splashes
- » Made with breathable Microforce barrier fabric
- » Coverall features micro-fibers that filter out many water-based liquids and dry particulates
- » Zipper front with 1" flap, elastic back, wrists and ankles
- » Passes NFPA 99 for antistatic materials

ITEM #	ORDER #	DESCRIPTION	UOM
46103	15400581	White, Large	25/Cs
46104	15400582	White, XLarge	25/Cs
46105	15400583	White, 2XLarge	25/Cs
46106	15400585	White, 3XLarge	21/Cs
46107	15400586	White, 4XLarge	21/Cs



44324



Kleenguard* A40 Liquid and Particle Protection Coveralls

- » Made of breathable, microporous film to keep out debris, non-hazardous liquid chemicals and dry particulates
- » Zipper front
- » Passes NFPA 99 for antistatic materials, pass ASTM F1670 testing for penetration of blood and bodily fluids, and meet the ANSI/ISEA 101-1996 sizing standard

ITEM #	ORDER #	DESCRIPTION	UOM
With Collar, Open Wrists and Ankles			
44303	15400303	White, Large	25/Cs
44304	15400304	White, XLarge	25/Cs
44305	15400305	White, 2XLarge	25/Cs
44306	15400306	White, 3XLarge	25/Cs
With Attached Hood, Elastic Wrists and Ankles			
44323	15400298	White, Large	25/Cs
44324	15400299	White, XLarge	25/Cs
44325	15401325	White, 2XLarge	25/Cs
44326	15400300	White, 3XLarge	25/Cs
44327	15400301	White, 4XLarge	25/Cs



Sleeves



NG500SWH00020000



DuPont™ ProShield® 60 Sleeves

- » Provides a barrier against a range of non-hazardous aerosols, light liquid splash and dry particles
- » Made with a microporous film that is laminated to a spunbonded polypropylene substrate
- » Applications include: automotive refinishing, waste cleanup and remediation
- » Serged seams, elastic at both ends (bicep and wrist) for arm protection

ITEM #	ORDER #	DESCRIPTION	UOM
NG500SWH00020000	31711577	18" Long, White, One Size Fits Most	200/Cs



DuPont™ Tyvek® 400 Sleeves

- » Breathable inherent Tyvek® 400 fabric barrier protection against hazardous dry particles, aerosols and non-hazardous light liquid splash
- » Applications include: lead and asbestos abatement/remediation, general maintenance/operations, spray painting, general clean-up
- » Serged seams, elastic at both ends (bicep and wrist) for arm protection

ITEM #	ORDER #	DESCRIPTION	UOM
TY500S	31710538	18" Long, White, One Size Fits Most	200/Cs



TY500S

Honeywell

NORTH

Perfect Fit™ Kevlar® Sleeves

- » 2-ply, Kevlar® knit sleeves with thumb hole, offer arm protection for glass and steel industries
- » Sleeves of DuPont™ Kevlar® engineered fiber helps prevent cut and slashes
- » Kevlar® is also flame resistant, and can withstand heat up to 900°F (400°C)

ITEM #	ORDER #	DESCRIPTION	UOM
KVS-2-18TH	341514211	Yellow, 18" Length	EA



KVS-2-18TH



Kevlar® Double-Ply Cut-Resistant Sleeves

- » 7-gauge double-ply Certified DuPont™ Kevlar® fiber sleeves
- » Will not melt, ignite or conduct electricity
- » ANSI cut score of A3
- » Made with FDA-accepted materials for use in food processing applications

ITEM #	ORDER #	DESCRIPTION	UOM
Economy, Coverage to Wrist			
9378E	331416411	18" Long	EA
Coverage to Palm, Thumb Slot, ANSI Abrasion Level 2			
9378T	331493781	18" Long	EA
Economy, Coverage to Palm, Thumb Slot			
9378TE	331416441	18" Long	EA



9378TE



2003



Classic 3-Piece Rain Suit

- » Yellow 0.35 mm PVC/polyester suit with welded seams
- » 3-piece suit includes: jacket with detachable hood and bib pants
- » Take up snaps on the wrists and ankles
- » Snap front jacket with 2 pockets and suspender bib pant with fly front

ITEM #	ORDER #	DESCRIPTION	UOM
2003-L	331455641	Large	EA
2003-XL	331455651	XLarge	EA
2003-2X	331455661	2XLarge	EA
2003-3X	331455671	3XLarge	EA
2003-4X	331449851	4XLarge	EA

⚠ WARNING: Cancer and Reproductive Harm - www.P65Warnings.ca.gov



2403R



Classic 3-Piece Reflective Suit

- » Yellow 0.35 mm PVC/polyester suit with welded seams
- » 3-piece suit includes: jacket with detachable hood and bib pants
- » Silver reflective material on the jacket and pants
- » Take up snaps on the wrists and ankles
- » Snap front jacket with 2 pockets and suspender bib pant with fly front

ITEM #	ORDER #	DESCRIPTION	UOM
2403R-L	331426321	Large	EA
2403R-XL	331426351	XLarge	EA
2403R-2X	331426361	2XLarge	EA

⚠ WARNING: Cancer and Reproductive Harm - www.P65Warnings.ca.gov

Rainwear



BJ38JHL



Big Jake Flame-Resistant Hi-Viz Jacket

- » Flame-resistant PVC/Nomex® jacket with 2" silver reflective stripes
- » Sturdy zipper front with large storm flap and cape ventilated back/D-ring access
- » Two front patch pockets
- » ANSI/ISEA 107-2015 Class 3, Type R Compliant
- » ASTM F1891 Standard Specification for Arc and Flame-Resistant Rainwear
- » HRC2 / CAT2, Arc Thermal Performance Value (ATPV) 8.9 cal/cm²

ITEM #	ORDER #	DESCRIPTION	UOM
BJ38JHM	331443361	Medium	EA
BJ38JHL	331443371	Large	EA
BJ38JHXL	331443381	XLarge	EA



Classic Rainwear Rider Coats

- » Black 0.35 mm PVC on polyester backing, 60" long coat
- » Split back can be snapped around each leg and worn as chaps
- » Detachable hood, corduroy collar
- » Cape ventilated back for air flow
- » Badge tab holder, 1 outer pocket with flap, 1 inner pocket



267C

ITEM #	ORDER #	DESCRIPTION	UOM
267C-L	331427171	Large	EA
267C-XL	331427201	XLarge	EA
267C-2X	331427211	2XLarge	EA
267C-3X	331427221	3XLarge	EA
267C-4X	331437381	4XLarge	EA

⚠ WARNING: Cancer and Reproductive Harm - www.P65Warnings.ca.gov



Rainwear



Classic Series 49" Raincoats

- » Yellow 0.35 mm PVC/polyester backing
- » Detachable hood with drawstring
- » Rounded collar of same material
- » 2 patch snap pockets on the front
- » Cape ventilated back, underarm air vents

ITEM #	ORDER #	DESCRIPTION	UOM
200C-M	331482561	Medium	EA
200C-L	331482571	Large	EA
200C-XL	331482581	XLarge	EA
200C-2X	331482591	2XLarge	EA

⚠ WARNING: Cancer and Reproductive Harm - www.P65Warnings.ca.gov



200C



Dominator Rainwear

- » Green two-piece suit: jacket with attached hood and inner sleeves, bib pants w/no fly
- » 0.42 mm PVC/Hi-tensile polyester/PVC
- » Zipper front with double storm flap, no pockets or vents
- » 10" x 10" reinforced crotch for durability
- » Limited flammability, NOT intended for use as protection against ARC Flash or Flash Fire



3882

ITEM #	ORDER #	DESCRIPTION	UOM
3882-L	331456491	Large	EA
3882-XL	331456501	XLarge	EA
3882-2X	331429241	2XLarge	EA
3882-3X	331436261	3XLarge	EA

⚠ WARNING: Cancer and Reproductive Harm - www.P65Warnings.ca.gov



Schooner Poncho

- » Blue 0.10 mm PVC disposable poncho
- » Attached hood
- » Fits easily into tool box, glove compartment or travel bag

ITEM #	ORDER #	DESCRIPTION	UOM
043	331423721	One Size Fits All	EA

⚠ WARNING: Cancer and Reproductive Harm - www.P65Warnings.ca.gov



043



Heat Pax Hand Warmers Displays

- » Open and shake pouch for 10 seconds
- » Warms up within 2 minutes
- » Lasts up to 8 hours
- » Great for gloves, pockets and winter gear
- » Avg. temp 120°F/49°C, max temp. 145°F/63°C



HR1100-80D

ITEM #	ORDER #	DESCRIPTION	UOM
HR1100-80D	325301845	Hand Warmers	40 Pr/Bx



ActivArm® 97-011 Cold Weather Gloves

- » 2-ply, inner layer of acrylic terry and the nitrile coating provides comfort and dexterity
- » 3/4 sandy nitrile dip provides secure grip and protection from liquid and cold
- » Bright orange liner offers extra visibility
- » ANSI Level A2 cut resistance and Level 4 abrasion resistance



97-011

ITEM #	ORDER #	DESCRIPTION	UOM
97-011-L	220170145	Size Large	6/Pk
97-011-XL	220170115	Size XLarge	6/Pk



70/6465NK



North Polar® Insulated Leather Palm Gloves

- » High performance protection in cold weather
- » Thinsulate® liner provides thermal protection, down to -36°F (-38°C)
- » Waterproof vinyl liner helps hands from getting wet
- » Gunn cut and wing thumb construction

ITEM #	ORDER #	DESCRIPTION	UOM
70/6465NK	347636145	Blue and Yellow, Size Large	12/Pk

⚠ WARNING: Cancer and Reproductive Harm - www.P65Warnings.ca.gov

Hand Protection



23-173



Winter Monkey Grip® Gloves

- » Tough orange PVC coating protects hands from abrasions and stays soft even when cold
- » PVC coating repels water, oil and grease
- » Foam insulation keeps hands warm and dry
- » Curved fingers, wing thumb and soft jersey lining
- » ANSI Level A1 cut resistance and Level 3 abrasion resistance

ITEM #	ORDER #	DESCRIPTION	UOM
Knitwrist Cuff Style			
23-173	220102365	Size 10	12/Pk
Safety Cuff Style			
23-193	220102375	Size 10	12/Pk



NFD11HD



NorthFlex Cold Grip Plus 5™ Thermal Protection Gloves

- » Double layer construction, high-level cut-resistant outer shell and thermal inner
- » Orange outer shell is a 18-gauge seamless knit, high visibility
- » Thermal interior provides extra cushion for palm
- » Recommended for temperatures -15°F (-26°C)
- » ANSI cut level A4 and EN511 level 2 resistance to contact cold

ITEM #	ORDER #	DESCRIPTION	UOM
NFD11HD/9L	341565975	Size 9/Large	12/Pk



Hand Protection



1565 Pigskin Insulated Work Gloves

- » Top grain pigskin palm and knuckle strap
- » Canvas back, Wing thumb
- » Thinsulate™ lining for warmth
- » Gunn cut with safety cuff

1565

ITEM #	ORDER #	DESCRIPTION	UOM
1565	C34119721	Size Large	PR

WARNING: Cancer and Reproductive Harm - www.P65Warnings.ca.gov



1578B Economy Winter-Lined Work Gloves

- » Cowhide split leather palm and knuckle strap
- » Canvas back, Wing thumb
- » Cotton/foam lined for warmth
- » Heavy-duty safety cuff

1578B

ITEM #	ORDER #	DESCRIPTION	UOM
1578B	C34104581	Size Large	PR

WARNING: Cancer and Reproductive Harm - www.P65Warnings.ca.gov



Artic Jack® Insulated Pigskin Leather Palm Gloves

- » Premium grain pigskin
- » Full sock Thermosock® lined
- » 2.5" rubberized safety cuff
- » Shirred elastic back
- » Wing thumb, gunn cut

1965

ITEM #	ORDER #	DESCRIPTION	UOM
1965-XL	331408245	Size XLarge	12/Pk

WARNING: Cancer and Reproductive Harm - www.P65Warnings.ca.gov



1568L

1568 Split Leather/Cotton Winter Gloves

- » Blue select shoulder cowhide palm and knuckle strap
- » Yellow canvas back
- » ColdBlock™ poly/cotton liner for warmth
- » Waterproof lining keeps hands dry
- » Heavy-duty safety cuff

ITEM #	ORDER #	DESCRIPTION	UOM
1568L	C34119741	Size Large	PR

WARNING: Cancer and Reproductive Harm - www.P65Warnings.ca.gov



Y0042L

Thermofill™ Lined Leather Palm Gloves

- » Premium pigskin leather palm
- » Thermofill™ lined
- » Fabric back with pigskin knuckle strap
- » Gunn cut, wing thumb, safety cuff

ITEM #	ORDER #	DESCRIPTION	UOM
Y0042L	416400455	Size Large	6/Pk



1320

Thermosock® Insulated Leather Palm Gloves

- » Thermosock® for warmth
- » 2.5" rubberized safety cuff
- » B grade select shoulder leather
- » Shirred elastic back
- » Wing thumb, gunn cut

ITEM #	ORDER #	DESCRIPTION	UOM
1320	331406545	Size Large	12/Pk



Hand Protection



N9690

Ninja® Ice Gloves

- » 15-gauge black nylon shell, 7-gauge acrylic terry interior liner
- » HPT repels liquids while providing wet or dry grip
- » Acrylic terry liner for insulation/warmth
- » Coating remains soft in temperatures low as -58°F
- » ANSI Cut A3, Abrasion 3, and Puncture 2

ITEM #	ORDER #	DESCRIPTION	UOM
N9690-L	331491015	Size Large	12/Pk



3460

Artic Jack® Insulated Premium Grain Pigskin Drivers Gloves

- » Premium grade grain pigskin
- » Thermosock® lined
- » Keystone thumb, gunn cut
- » Shirred elastic back
- » Color-coded hem to identify size

ITEM #	ORDER #	DESCRIPTION	UOM
3460-L	331409665	Size Large	12/Pk



Knucklehead™ X10 Armor Skin™ Insulated Mechanics Gloves

- » Armor Skin™ synthetic leather palm with PVC palm patch
- » Knit back with full finger and back of hand TPR impact protection
- » Elastic cuff closure
- » 100 gram Thinsulate® lined, Waterproof and windproof
- » ANSI cut level 3, EN puncture level 2

ITEM #	ORDER #	DESCRIPTION	UOM
High Visibility Orange			
21247H0/9	337982465	Size 9	12/Pk
21247H0/10	337982475	Size 10	12/Pk
21247H0/11	337982485	Size 11	12/Pk
21247H0/12	337982495	Size 12	12/Pk



21247H0



Emperor Penguin® Winter-Lined Nylon Gloves

- » 15-gauge nylon shell, 10-gauge acrylic liner
- » Sandy dipped palm, Pre-curved finger design
- » High visibility yellow knit
- » Exceptional liquid resistance and grip
- » CE Cut Level 3, ANSI A2



3398DNY

ITEM #	ORDER #	DESCRIPTION	UOM
Waterproof, Closed Cell Nitrile Dip Palm			
3398DNY/M	337903995	Size Medium	12/Pk
3398DNY/L	337904005	Size Large	12/Pk
3398DNY/XL	337904015	Size XLarge	12/Pk
3398DNY/XXL	337904025	Size XXLarge	12/Pk



Head & Clothing



14502



Jackson Safety* 225 Plus Winterliner

- » For cold environments ranging from 32° to 0°F
- » Hook-and-loop chin fastener
- » Outer shell: quilted nylon with foam fill
- » Lining: polyester fleece
- » Meets 16 CFR 1610, Class 1

ITEM #	ORDER #	DESCRIPTION	UOM
14502	C2412409	Blue, Universal Size	EA



14497



Jackson Safety* AA-9 Wingard* Head Protection

- » Full head and neck liner with wide wraparound collar

ITEM #	ORDER #	DESCRIPTION	UOM
14497	C24134371	Navy Blue, Universal Size	EA



V-Gard® Value Winter Liners

- » Deliver extra warmth and protection

ITEM #	ORDER #	DESCRIPTION	UOM
Skullie Knit Cap			
10118417	3085866D1	100% High Bulk Acrylic	EA
Knit Full-Face Tube, Mounts Under or Over Caps or Hats			
10118418	3085867D1	100% Acrylic, Bright Yellow-Green	EA



10118417



10118418



16753

TREX 6300 Ice Traction Devices

- » One-piece lightweight ice traction device delivers grip and stability for shoes and boots
- » 8 rugged, heat-treated carbon steel studs
- » Stretchable rubber for fit and easy on/off
- » Lightweight, and flexible to -40°F (-40°C)
- » TREX® 6301 replacement studs sold separately

ITEM #	ORDER #	DESCRIPTION	UOM
16753	332103631	Medium - US Mens 5-8	PR
16754	332103641	Large - US Mens 8-11	PR
16755	332103651	XLarge - US Mens 11-15	PR
16756	332103691	XXLarge - US Mens 15-18	PR



LB600

Classic Mid-Length Winter Liner

- » 2 layers: 100% cotton twill top, fleece lining
- » Flame-resistant treatment until washed

ITEM #	ORDER #	DESCRIPTION	UOM
LB600	325316001	Navy	EA



Head & Clothing



1070-CAMO

Hot Rods 3-in-1 Fleece Balaclava

- » Wear 3-ways: around the neck, around head and chin and covering head, chin and nose
- » Velour inner/jersey outer, 5.8 oz. Nomex®/Kevlar® blend
- » Drawstring for fit, hook and loop tabs to hard hat

ITEM #	ORDER #	DESCRIPTION	UOM
1070-CAMO	325305011	Camouflage	EA



RK800-01

Classic Hard Hat Tube Liner

- » Polyester knit pullover fits most regular brim hard hats
- » Keep your ears warm and the heat locked in

ITEM #	ORDER #	DESCRIPTION	UOM
RK800-01	325318001	Navy	EA
Full-Face			
LK810-03	325301941	Red	EA



LZ620

Premium Shoulder-Length Two-Way

- » 2 layers: 100% cotton twill top, fleece lining
- » 100% spun polyester bottom
- » Double button neck closure, zipper on/off
- » Buttons and zippers are plastic - no metal parts

ITEM #	ORDER #	DESCRIPTION	UOM
LZ620	325301981	Navy / Black	PR



LK910FR

Classic Flame-Resistant Hard Hat Tube Liner

- » 9.5 oz. modacrylic soft rib knit
- » Nomex® thread
- » Fits snugly over most regular brim hard hats
- » Arc Rating: ATPV = 11.6 cal/cm², NFPA 70E/HRC = 2
- » Meets ASTM F1506, flame-resistant for life of garment

ITEM #	ORDER #	DESCRIPTION	UOM
RK900FR	325309251	Navy	EA
Full Face			
LK910FR	325309191	Navy	EA



Winter Liners

- » Shoulder-length cold weather liners

ITEM #	ORDER #	DESCRIPTION	UOM
2 Layers: 50% Acrylic/50% Polyester Sherpa Lining			
SS550	325302291	Sherpa, Navy	EA
260 GM Polyspandex Knit and Binding			
SS260-BK	325313211	Hinged Balaclava, Black	EA



SS550



SS260-BK



Head & Clothing



75-1300



High Visibility Waterproof Jacket with Quilted Liner

- » Economical high visibility yellow bomber jacket with fixed quilted liner
- » PU coated polyester with fully taped seams and concealed attached hood
- » Elastic ribbed waist, wrist, and collar
- » Outside slash pockets and a cell phone pocket
- » Meets ANSI / ISEA 107-2015 Class 3, Type R

ITEM #	ORDER #	SIZE	UOM
75-1300/M	337913011	Medium	EA
75-1300/L	337913021	Large	EA
75-1300/X1	337913031	XLarge	EA
75-1300/X2	337913041	XXLarge	EA



LUX-350-JB-BYL



2-in-1 Black Bottom Bomber

- » 100% polyester 300 denier oxford with PU coating
- » Easy on and off zip-out quilted lining
- » Fleece lined collar, roll-away hood
- » Pockets: 2 inside (including a tablet pocket), 2 lower front with zipper, left sleeve pencil with 2 compartments and 1 front flap
- » 2" silver reflective tape
- » ASTM F 2732 Temperature Rating: -5°-45°F

ITEM #	ORDER #	DESCRIPTION	UOM
LUX-350-JB-BYM	325313141	Size Medium	EA
LUX-350-JB-BYML	325313151	Size Large	EA
LUX-350-JB-BYMXL	325313161	Size XLarge	EA
LUX-350-JB-BYM2X	325313171	Size XXLarge	EA



75-5327



High Visibility Hooded Pullover Sweatshirt

- » Deluxe high visibility yellow hooded pullover sweatshirt
- » Black in the areas that get the most soiled
- » 3M reflective striping
- » Meets ANSI/ISEA 107-2015 Class 3, Type R Standard

ITEM #	ORDER #	SIZE	UOM
75-5327/M	337953511	Medium	EA
75-5327/L	337953521	Large	EA
75-5327/X1	337953531	XLarge	EA
75-5327/X2	337953541	XXLarge	EA



LUX-ETJBJR-YL



Classic Three-Way Black Bottom Bomber Jackets

- » 2" silver reflective tape
- » 100% ANSI polyester with PU coating - waterproof - sealed seams
- » 100% black polyester fleece, zip-out liner can be worn as a separate jacket
- » Pockets: 2 outer, 1 inner, 1 radio, left sleeve pencil with 2 compartments and 2 mic tabs
- » Class 3, ASTM F 2732 temperature rating: 1°-46°F

ITEM #	ORDER #	DESCRIPTION	UOM
LUX-ETJBJR-YM	325357891	Size Medium	EA
LUX-ETJBJR-YL	325357881	Size Large	EA
LUX-ETJBJR-YXL	325357901	Size XLarge	EA
LUX-ETJBJR-Y2X	325357911	Size XXLarge	EA



Hi-Viz Apparel

ML KISHIGO®



1085

3 Pocket Zipper Mesh Vest

- » Ultra-Cool 100% polyester mesh
- » Zipper front closure
- » 2" wide high performance reflective material
- » Left chest mic tab
- » Outside left chest radio pocket with hook & loop tab
- » Inside right chest 2-tier, 4-division pencil pocket
- » Lower inside left patch pocket
- » ANSI 107 Type R | Class 2 Compliant

ITEM #	ORDER #	SIZE	UOM
1085-M	K04700141	Medium	EA
1085-L	K04700151	Large	EA
1085-XL	K04700161	XLarge	EA
1085-2X	K04700171	2XLarge	EA

⚠ WARNING: Cancer and Reproductive Harm - www.P65Warnings.ca.gov

ML KISHIGO®



1191

6 Pocket Zipper Mesh Vest

- » 100% polyester mesh material with solid polyester pockets
- » Zipper front closure
- » 2" wide reflective material
- » Left chest mic tab
- » Two lower outside patch pockets with flaps
- » Right chest 2-division pocket
- » Left chest 4-division pocket
- » Two inside patch pockets
- » ANSI 107 Type R | Class 2 Compliant

ITEM #	ORDER #	SIZE	UOM
1191-S-M	K04700451	S-M	EA
1191-L-XL	K04700461	L-XL	EA
1191-2X-3X	K04700471	2XL-3XL	EA

⚠ WARNING: Cancer and Reproductive Harm - www.P65Warnings.ca.gov

ML KISHIGO®



1194

Single Pocket Hook and Loop Mesh Vest

- » 100% polyester mesh
- » 4" hook & loop front closure
- » 2" wide reflective material
- » Left chest mic tab and chest pocket
- » ANSI 107 Type R | Class 2 Compliant

ITEM #	ORDER #	SIZE	UOM
Lime			
1193-S-M	K04700491	S-M	EA
1193-L-XL	K04700501	L-XL	EA
1193-2X-3X	K04700511	2XL-3XL	EA
Orange			
1194-S-M	K04700531	S-M	EA
1194-L-XL	K04700541	L-XL	EA
1194-2X-3X	K04700551	2XL-3XL	EA

⚠ WARNING: Cancer and Reproductive Harm - www.P65Warnings.ca.gov

ML KISHIGO®



1520

3 Pocket Zipper Mesh Vest

- » 100% polyester mesh
- » Zipper front closure
- » 2" wide reflective material
- » Left chest mic tab
- » Left chest pocket
- » ANSI 107 Type R | Class 2 Compliant

ITEM #	ORDER #	SIZE	UOM
Lime			
1519-S-M	K04700911	S-M	EA
1519-L-XL	K04700921	L-XL	EA
1519-2X-3X	K04700931	2XL-3XL	EA
Orange			
1520-S-M	K04700951	S-M	EA
1520-L-XL	K04700961	L-XL	EA
1520-2X-3X	K04700971	2XL-3XL	EA

⚠ WARNING: Cancer and Reproductive Harm - www.P65Warnings.ca.gov



Hi-Viz Apparel

ML KISHIGO®

Black Bottom Mesh Vest

- » 100% polyester mesh material
- » Solid black polyester on lower front
- » Zipper front closure
- » 2" wide reflective material
- » Left and right chest mic tabs
- » Two lower front solid patch pockets with flaps
- » Left chest radio pocket
- » Right chest 2-tier pocket
- » Two large lower inside pockets
- » ANSI 107 Type R | Class 2 Compliant



1509

ITEM #	ORDER #	SIZE	UOM
1509-S-M	K04700721	S-M	EA
1509-L-XL	K04700731	L-XL	EA
1509-2X-3X	K04700741	2XL-3XL	EA

WARNING: Cancer and Reproductive Harm - www.P65Warnings.ca.gov

ML KISHIGO®

All Mesh Contrast Vest

- » Ultra-Cool™ 100% polyester mesh
- » Zipper front closure
- » 2" wide high performance reflective material with 3" breathable contrasting color
- » Left and right chest mic tabs
- » Two lower outside patch pockets with flaps
- » Right chest 2-tier pencil pocket
- » Left chest radio pocket with flap
- » Two inside patch pockets
- » ANSI 107 Type R | Class 2 Compliant



1195

ITEM #	ORDER #	SIZE	UOM
1195-M	K04700571	Medium	EA
1195-L	K04700581	Large	EA
1195-XL	K04700591	XLarge	EA
1195-2X	K04700601	2XLarge	EA

WARNING: Cancer and Reproductive Harm - www.P65Warnings.ca.gov

ML KISHIGO®

3 Pocket Zipper Mesh Vest

- » Ultra-Cool™ 100% polyester mesh
- » Zipper front closure
- » 2" wide high performance reflective material with 4.5" contrasting color
- » Inside left chest 2-tier, 4-division pencil pocket
- » Lower right inside patch pocket
- » ANSI 107 Type R | Class 2 Compliant



1056

ITEM #	ORDER #	SIZE	UOM
1056-M	K04701191	Medium	EA
1056-L	K04701201	Large	EA
1056-XL	K04701211	XLarge	EA
1056-2X	K04701221	2XLarge	EA

WARNING: Cancer and Reproductive Harm - www.P65Warnings.ca.gov

ML KISHIGO®

4 Season Adjustable Mesh Vest

- » Ultra-Cool™ 100% polyester mesh
- » Hook & loop front closure
- » Allows for accurate sizing in any weather even over bulky coats
- » Two 1" wide high performance reflective material with 4.5" contrasting color
- » Outside left chest 2-tier pencil pocket
- » Inside right chest 2-tier pencil/cell pocket
- » Two inside lower patch pockets
- » ANSI 107 Type R | Class 2 Compliant



1166

ITEM #	ORDER #	SIZE	UOM
1166-M-XL	K04701141	M-XL	EA
1166-2X-4X	K04701151	2XL-4XL	EA

WARNING: Cancer and Reproductive Harm - www.P65Warnings.ca.gov



Hi-Viz Apparel

ML KISHIGO®



1527

Single Pocket Contrasting Mesh Vest

- » 100% polyester mesh
- » Zipper front closure
- » 2" wide reflective material with 3" contrasting color
- » Left chest mic tab
- » Left chest pocket
- » ANSI 107 Type R | Class 2 Compliant

ITEM #	ORDER #	SIZE	UOM
1527-S-M	K04700991	S-M	EA
1527-L-XL	K04701001	L-XL	EA
1527-2X-3X	K04701011	2XL-3XL	EA

⚠ WARNING: Cancer and Reproductive Harm - www.P65Warnings.ca.gov



1242

6 Pocket Contrast Mesh Vest

- » Ultra-Cool™ 100% polyester mesh with solid pockets
- » Zipper front closure
- » 2" wide high performance reflective material with 3" contrasting mesh
- » Left chest mic tab, outside left chest radio pocket
- » Outside right chest 2-tier, 3-division pocket
- » Inside lower patch pockets
- » Two lower outside solid material patch pockets with flaps
- » ANSI 107 Type R | Class 3 Compliant

ITEM #	ORDER #	SIZE	UOM
1242-M	K04700651	Medium	EA
1242-L	K04700661	Large	EA
1242-XL	K04700671	XLarge	EA
1242-2X	K04700681	2XLarge	EA

⚠ WARNING: Cancer and Reproductive Harm - www.P65Warnings.ca.gov

ML KISHIGO®

Solid Front with Mesh Back Vest

- » Comfortable Ultra-Cool™ 100% polyester mesh material on back with solid front
- » Zipper front closure
- » 2" wide high performance reflective material with 3" contrasting color
- » Left and right chest mic tabs
- » Two lower outside patch pockets with flaps
- » Right chest 2-tier, 4-division pocket
- » Left chest radio pocket with flap
- » Two lower inside patch pockets
- » ANSI 107 Type R | Class 2 Compliant



1164

ITEM #	ORDER #	SIZE	UOM
Lime			
1163-M	K04700221	Medium	EA
1163-L	K04700231	Large	EA
1163-XL	K04700241	XLarge	EA
1163-2X	K04700251	2XLarge	EA

ITEM #	ORDER #	SIZE	UOM
Orange			
1164-M	K04700301	Medium	EA
1164-L	K04700311	Large	EA
1164-XL	K04700321	XLarge	EA
1164-2X	K04700331	2XLarge	EA

⚠ WARNING: Cancer and Reproductive Harm - www.P65Warnings.ca.gov

ML KISHIGO®

Short Sleeve Class 2 T-Shirt Lime

- » Microfiber polyester material wicks away moisture
- » 2" wide high performance reflective material
- » Left chest pocket
- » ANSI 107 Type R | Class 2 Compliant



9110

ITEM #	ORDER #	SIZE	UOM
9110-M	K04700141	Medium	EA
9110-L	K04700151	Large	EA
9110-XL	K04700161	XLarge	EA
9110-2X	K04700171	2XLarge	EA

⚠ WARNING: Cancer and Reproductive Harm - www.P65Warnings.ca.gov



Hi-Viz Apparel

ML KISHIGO®

Premium Brilliant Series® Heavy Duty Vest

- » Ultra-Cool™ 100% polyester mesh
- » Brilliant Trim reflective edging improves low light visibility
- » Zipper front closure reinforced with durable webbing
- » 2" wide high performance reflective material with 3" breathable contrasting color
- » Left and right chest mic tabs
- » Two lower outside cargo pockets with grommets
- » Right chest 2-tier pencil pocket
- » Left chest radio pocket with flap
- » Two inside patch pockets
- » ANSI 107 Type R | Class 2 Compliant



1510

ITEM #	ORDER #	SIZE	UOM
1510-M	K04700771	Medium	EA
1510-L	K04700781	Large	EA
1510-XL	K04700791	XLarge	EA
1510-2X	K04700801	2XLarge	EA

⚠ WARNING: Cancer and Reproductive Harm - www.P65Warnings.ca.gov

ML KISHIGO®

Hard Hat Sun Shield

- » Keeps your neck well shaded
- » Elastic band to fit over most hard hats
- » Ultra-Cool™ 100% polyester mesh with contrasting trim
- » 5/8" wide high performance reflective material with contrasting material



2810

ITEM #	ORDER #	DESCRIPTION	UOM
2810	K04701161	Lime	EA
2813	K04701171	Orange	EA

ML KISHIGO®

Premium Black Series® Black Bottom Vest

- » Ultra-Cool™ 100% polyester mesh with black bottom and trim
- » Zipper front closure with durable webbing reinforcement.
- » 2" wide high performance reflective material with 3" breathable contrasting color
- » Reflective trim around arms & piping down sides and along utility pocket for added low light visibility
- » Left and right chest mic tabs
- » Two lower outside heavy duty expandable cargo pockets with adjustable flaps and grommets
- » Right chest 2-tier, 4-division pencil pocket
- » Left chest heavy duty gusseted radio/utility pocket
- » Inside lower left heavy duty tablet (iPad) pocket with load-bearing strap
- » Inside lower right patch pocket.
- » ANSI 107 Type R | Class 2 Compliant



1515

ITEM #	ORDER #	SIZE	UOM
1515-M	K04700841	Medium	EA
1515-L	K04700851	Large	EA
1515-XL	K04700861	XLarge	EA
1515-2X	K04700871	2XLarge	EA

⚠ WARNING: Cancer and Reproductive Harm - www.P65Warnings.ca.gov

ML KISHIGO®

Warning Flag

- » 18" x 18" red/orange reinforce vinyl material
- » 3/4" x 24" hardwood dowel

STOP/SLOW Non-Reflective Sign

- » 18" Screened hard board
- » 9" Handle



1600



5950

ITEM #	ORDER #	DESCRIPTION	UOM
1600	K04701121	Standard Warning Flag	EA
5950	K04701131	STOP/SLOW Non-Reflective Sign	EA



Hi-Viz Apparel

HI-VIZ APPAREL



V201



V201R

General Purpose Safety Vest

- » Non-ANSI
- » Polyester mesh
- » Hook and loop tab front closure
- » Elastic strap on each side
- » No Reflective stripes

ITEM #	ORDER #	SIZE	UOM
Lime			
331422001	V200	One Size	EA
Orange			
331422011	V201	One Size	EA
Orange with 2" Lime/Silver reflective stripes			
331423601	V201R	One Size	EA

⚠ WARNING: Cancer and Reproductive Harm - www.P65Warnings.ca.gov



FRMBCL2LL

Class 2 Flame-Resistant Break Away Vest

- » FR solid modacrylic/aramid blend fabric
- » 2" silver FR reflective stripes
- » 5 point break away feature
- » Hook and loop closures
- » Conforms to NFPA 70E, HRC1, arc rating 5.4 cal/cm, meets ASTM F1506
- » No pockets
- » ANSI/ISEA 107-2015 Class 2, Type R Compliant

ITEM #	ORDER #	SIZE	UOM
FRMBCL2LL	331407461	Large	EA
FRMBCL2LXL	331407481	XLarge	EA
FRMBCL2LX2	331407501	2XLarge	EA
FRMBCL2LX3	331407531	3XLarge	EA



General Purpose Safety Vest

- » Non-ANSI
- » Orange polyester mesh
- » 3/4" Lime reflective stripes
- » Cool and lightweight
- » Hook and loop tab front closure
- » Elastic strap on each side



V211R

ITEM #	ORDER #	SIZE	UOM
331420851	V211R	One Size	EA
331420855	V211R	One Size	12/PK

⚠ WARNING: Cancer and Reproductive Harm - www.P65Warnings.ca.gov



SURVCL2L

Class 2 Surveyor Style Mesh Vest

- » Reinforced zipper front
- » 2 upper and 2 lower grommets
- » 3" reflective stripes
- » Clear badge holder, mic-tab holder, 4 outer - 2 inner pockets
- » ANSI/ISEA 107-2015 Class 2, Type R

ITEM #	ORDER #	SIZE	UOM
Lime			
SURVCL2LM	331442181	Medium	EA
SURVCL2LL	331442051	Large	EA
SURVCL2LXL	331442191	XLarge	EA
Orange			
SURVCL2OM	331443321	Medium	EA
SURVCL2OL	331443331	Large	EA
SURVCL2OXL	331443341	XLarge	EA

⚠ WARNING: Cancer and Reproductive Harm - www.P65Warnings.ca.gov



Hi-Viz Apparel



Class 2 Safety Vest

- » 100% polyester fluorescent yellow mesh material
- » 2" reflective tape on shoulders and chest
- » Secure with front hook and loop closure
- » ANSI 107-2010 Class 2 compliant

ITEM #	ORDER #	SIZE	UOM
690-1208	G73512081	Medium	EA
690-1209	G73512091	Large	EA
690-1210	G73512101	XLarge	EA
690-1211	G73512111	2XLarge	EA
690-1212	G73512121	3XLarge	EA



690-1208



Value Mesh Two-Tone

- » 1.375" silver reflective tape backed by contrasting trim
- » 100% polyester mesh
- » Elastic side straps
- » Pockets: 1 inner lower left
- » Hook and loop closure
- » Yellow



LUX-XTTM-YR

ITEM #	ORDER #	SIZE	UOM
LUX-XTTM-YR	325307911	Regular	EA



Value Mesh with Gloss Tape

- » Non-ANSI
- » 1" yellow gloss reflective tape on orange vest, 1" white gloss on yellow vest
- » 100% polyester mesh
- » Elastic side straps
- » Pockets: 1 inner lower left
- » Hook and loop closure



LUX-XGTM

ITEM #	ORDER #	SIZE	UOM
LUX-XGTM-OR	325347521	Regular	EA

WARNING: Cancer and Reproductive Harm - www.P65Warnings.ca.gov



Class 2 Premium Two-Tone Expandable Vest

- » 2" 3M™ Scotchlite™ reflective material backed by contrasting ANSI compliant trim
- » 100% ANSI polyester mesh
- » Pockets: 1 outer left chest, 2 inner lower
- » Zipper closure
- » Yellow



LUX-SC2TZ

ITEM #	ORDER #	SIZE	UOM
LUX-SC2TZ-YM/L	325300051	Medium/Large	EA
LUX-SC2TZ-YXL/2	325300061	XLarge/2XLarge	EA
LUX-SC2TZ-Y3/4X	325300071	3XLarge/4XLarge	EA



Hi-Viz Apparel



Class 2 Value Solid Standard Vest

- » 2" silver reflective tape
- » 100% ANSI polyester tricot
- » Dual-sized
- » Hook and loop closure

ITEM #	ORDER #	SIZE	UOM
Yellow			
ECO-G-YL/XL	325343111	Large/XLarge	EA
ECO-G-Y2/3X	325343121	2XLarge/3XLarge	EA
ECO-G-Y4/5X	325343131	4XLarge/5XLarge	EA
Orange			
ECO-G-OL/XL	325343011	Large/XLarge	EA
ECO-G-O2/3X	325343021	2XLarge/3XLarge	EA
ECO-G-O4/5X	325343031	4XLarge/5XLarge	EA



ECO-G-0



ECO-GC



Class 2 Value Mesh Standard Vest

- » 2" silver reflective tape
- » 100% ANSI polyester mesh
- » Dual-sized
- » Pockets: 1 inside left chest with hook and loop closure
- » Hook and loop closure
- » Yellow

ITEM #	ORDER #	SIZE	UOM
ECO-GC-YS/M	325347531	Small/Medium	EA
ECO-GC-YL/XL	325347541	Large/XLarge	EA
ECO-GC-Y2/3X	325347551	2XLarge/3XLarge	EA
ECO-GC-Y4/5X	325347561	4XLarge/5XLarge	EA



Class 2 Classic Mesh Surveyor Safety Vest

- » 2" silver reflective tape
- » 100% ANSI polyester mesh
- » Pockets: 2 inner lower w/ pen compartment, 4 pen on outer right chest, 1 outer left double w/ 4 pen compartments
- » Zipper closure

ITEM #	ORDER #	SIZE	UOM
Yellow			
LUX-SSGCS-YL/XL	325351121	Large/XLarge	EA
LUX-SSGCS-Y2/3X	325341131	2XLarge/3XLarge	EA
Orange			
LUX-SSGCS-OL/XL	325347381	Large/XLarge	EA
LUX-SSGCS-O2/3X	325347391	2XLarge/3XLarge	EA



LUX-SSGCS-0



Hi-Viz Apparel



Class 3 Zipper-Front Mesh Vest

- » 2" silver reflective tape
- » 100% ANSI polyester mesh
- » Dual-sized
- » Pockets: 2 inner lower front
- » Zipper closure
- » Yellow



ECO-GCZ3

ITEM #	ORDER #	SIZE	UOM
ECO-GCZ3-YS/M	325347001	Small/Medium	EA
ECO-GCZ3-YL/XL	325347011	Large/XLarge	EA
ECO-GCZ3-Y2/3X	325347021	2XLarge/3XLarge	EA
ECO-GCZ3-Y4/5X	325347031	4XLarge/5XLarge	EA



Economy Two-Tone Mesh Vest

- » 2" silver reflective tape set on 4" contrast band
- » ANSI 107 100% polyester mesh
- » Mic tab
- » Pockets: 1 smartphone flap chest pocket with gusset, 1 large inside pocket and 1 inside pencil pocket
- » Yellow



ECO-IMZ32T

ITEM #	ORDER #	SIZE	UOM
ECO-IMZ32T-YL	325310651	Large	EA
ECO-IMZ32T-YXL	325310661	XLarge	EA
ECO-IMZ32T-Y2X	325310671	2XLarge	EA



Classic Black Bottom T-Shirt

- » 2" silver reflective tape
- » 100% ANSI wicking birdseye
- » 3.8 oz. fabric weight
- » Lightweight fabric
- » Black bottom front to hide dirt
- » Pocket: 1 left chest
- » Yellow



LUX-SSETPBK

ITEM #	ORDER #	SIZE	UOM
LUX-SSETPBK-L	325327571	Large	EA
LUX-SSETPBK-XL	325327581	XLarge	EA
LUX-SSETPBK-2X	325377221	2XLarge	EA



Black Bottom Hoodie Sweatshirt

- » 2" silver reflective tape
- » 100% 9 oz. polyester fleece
- » Elastic cuffs and waistband
- » Pockets: 2 lower front
- » ASTM F 2732 Temperature Rating: 9°-52°F



LUX-SWTHZBK

ITEM #	ORDER #	SIZE	UOM
LUX-SWTHZBK-YL	325310501	Large	EA
LUX-SWTHZBK-YXL	325310531	XLarge	EA
LUX-SWTHZBK-Y2X	325310461	2XLarge	EA
LUX-SWTHZBK-Y3X	325310471	3XLarge	EA



Hi-Viz Apparel



75-3202

Class 2 Mesh Vest

- » Includes one inside chest pocket and two inside waist pockets
- » Zipper front closure
- » 2" reflective striping
- » ANSI/ISEA 107-2015 Class 2, Type R Standard

ITEM #	ORDER #	SIZE	UOM
Yellow			
75-3201/S	337914301	Small	EA
75-3201/M	337914311	Medium	EA
75-3201/L	337914321	Large	EA
75-3201/X1	337914331	XLarge	EA
75-3201/X2	337914341	2XLarge	EA
75-3201/X3	337914351	3XLarge	EA



75-3239

Class 2 Mesh Vest with DOT Reflective Chainsaw Striping

- » Reflective chainsaw patterned striping for breathability with DOT contrasting
- » Large chest pen pocket, two large waist pockets with Velcro® closure
- » Two large inside waist pockets, left pocket with security strap for electronic tablet
- » ID badge holder
- » Two radio mic tabs
- » Heavy duty front zipper
- » ANSI/ISEA 107-2015 Class 2, Type R Standard

ITEM #	ORDER #	SIZE	UOM
Yellow			
75-3239/M	337901231	Medium	EA
75-3239/L	337901241	Large	EA
75-3239/X1	337901251	XLarge	EA
75-3239/X2	337901261	2XLarge	EA



Waterproof Bib Overall with Quilted Insulation

- » Sturdy plastic shoulder strap buckles
- » Zipper chest pocket with slash side pockets
- » Bottom leg zippers to pull on over boots
- » Snap closures on the bottom of the ankle hem insure a snug fit
- » Black areas are reinforced with nylon ripstop to help prevent tearing and ripping
- » Deep pockets on double layer knees allow for increased wear and optional knee pad
- » Includes removable knee pads
- » ANSI/ISEA 107-2015 Class E Standard

ITEM #	ORDER #	SIZE	UOM
75-2357/L	337944511	Large	EA
75-2357/X1	337944521	XLarge	EA
75-2357/X2	337944531	2XLarge	EA



75-2357



Hi-Viz Apparel



75-1313



Class 3 Waterproof Jacket with Quilted Liner

- » Fixed quilted liner
- » PU coated polyester with fully taped seams and concealed attached hood
- » Elastic ribbed waist, wrist and collar
- » Outside slash pockets and a cell phone pocket
- » ANSI/ISEA 107-2015 Class 3, Type R Standard

ITEM #	ORDER #	SIZE	UOM
75-1313/L	337914071	Large	EA
75-1313/X1	337913891	XLarge	EA
75-1313/X2	337913791	2XLarge	EA
75-1313/X3	337913691	3XLarge	EA



75-1300



High Visibility Waterproof Jacket with Quilted Liner

- » Economical high visibility yellow bomber jacket with fixed quilted liner
- » PU coated polyester with fully taped seams and concealed attached hood
- » Elastic ribbed waist, wrist, and collar
- » Outside slash pockets and a cell phone pocket
- » Meets ANSI / ISEA 107-2015 Class 3, Type R

ITEM #	ORDER #	SIZE	UOM
75-1300/M	337913011	Medium	EA
75-1300/L	337913021	Large	EA
75-1300/X1	337913031	XLarge	EA
75-1300/X2	337913041	2XLarge	EA



75-5355



High Visibility Long Sleeve Shirt

- » Deluxe high visibility yellow birdseye mesh long sleeve T-shirt
- » Double waist 3M stripes and extended vertical striping
- » Left chest pocket
- » Outstanding wicking ability that helps you stay cool on the job
- » Meets ANSI/ISEA 107-2015 Class 3, Type R Standard

ITEM #	ORDER #	SIZE	UOM
75-5355/M	337953711	Medium	EA
75-5355/L	337953721	Large	EA
75-5355/X1	337953731	XLarge	EA
75-5355/X2	337953741	2XLarge	EA



75-5327



High Visibility Hooded Pullover Sweatshirt

- » Deluxe high visibility yellow hooded pullover sweatshirt
- » Black in the areas that get the most soiled
- » 3M reflective striping
- » Meets ANSI/ISEA 107-2015 Class 3, Type R Standard

ITEM #	ORDER #	SIZE	UOM
75-5327/M	337953511	Medium	EA
75-5327/L	337953521	Large	EA
75-5327/X1	337953531	XLarge	EA
75-5327/X2	337953541	2XLarge	EA



Rechargeable



75713



Stinger® Rechargeable LED Flashlight

- » Premier rechargeable duty light
- » Machined aircraft aluminum body with non-slip rubberized comfort grip
- » High/medium/low/strobe modes
- » 3-cell, 3.6 Volt NiMH sub-C battery, rechargeable up to 1000 times
- » IPX4 water-resistant; 1m impact resistance tested
- » Serialized for positive identification
- » Multi-function On/Off push-button switch
- » Limited lifetime warranty
- » Assembled in USA

ITEM #	ORDER #	DESCRIPTION	UOM
75713	342300131	Rechargeable LED Flashlight	EA



74751



Strion LED HL® Rechargeable Flashlight

- » Extraordinary brightness in a wide beam pattern
- » Multi-function On/Off push-button tail switch lets you choose three lighting modes and strobe
- » Lithium ion battery is rechargeable up to 1000 times; fully recharges in 3 hrs.
- » LED technology, impervious to shock with a 50,000 hour lifetime
- » IPX4 water-resistant; 2 meter impact resistance tested
- » Anti-roll head prevents the light from rolling away when you set it down
- » Serialized for positive identification

ITEM #	ORDER #	DESCRIPTION	UOM
74751	342300391	Rechargeable LED Flashlight	EA

Headlamps



Enduro® Pro Headlamp

- » Sleek, Multi-Function LED Headlamp with 200 Lumens
- » Spot for distance lighting
- » Flood for area illumination for tasks at arm's length
- » 45° tilting head and elastic headstrap
- » Powered by 3 "AAA" alkaline batteries (included)

ITEM #	ORDER #	DESCRIPTION	UOM
61422	342300211	LED Headlamp	EA



61422

Headlamps



61703

Bandit® Rechargeable LED Headlamp

- » Produces bright, even light with less shadow than spot beams
- » Provides 180 lumens of widespread white light: LED with high, low and emergency flash
- » USB rechargeable; charges in approx. 2.5 hours
- » Lightweight -1.30 oz. (36.85g) and low profile

ITEM #	ORDER #	DESCRIPTION	UOM
61703	342300201	Rechargeable LED Headlamp	EA



3AA HAZ-LO® Headlamp

- » Intrinsically Safe - Class I, Div 1
- » 120 lumens, 165 meter beam distance, runs 11 hours
- » Push-button on/off switch easy to use even when wearing heavy gloves
- » Package includes both elastic head strap and rubber hard hat strap
- » Powered by 3 "AA" alkaline batteries (included)

ITEM #	ORDER #	DESCRIPTION	UOM
61200	342300241	3AA LED Headlamp	EA



61200



Trident® LED Headlamp

- » Meets lighting needs for both close-up and distance work
- » Features center C4® LED and three ultra-bright white 5mm LEDs
- » Single button operation for multiple light settings: C4 LED for super-bright light, 3 ultra-bright white LEDs for bright light, 1 ultra-bright white LED for extended run times
- » Powered by 3 "AAA" alkaline batteries (included)

ITEM #	ORDER #	DESCRIPTION	UOM
61050	342300231	LED Headlamp	EA



61050



Argo® LED Headlamp

- » Illuminates objects at a distance
- » Three modes: High (150 lumens); Medium (100 lumens); Low (45 lumens)
- » 90° tilting head features a robust ratcheting system; prevents neck fatigue
- » Push-button switch is easy to use when wearing gloves
- » Powered by 3 "AAA" alkaline batteries (included)

ITEM #	ORDER #	DESCRIPTION	UOM
61301	342300221	LED Headlamp	EA



61301



Double Functionality



67751

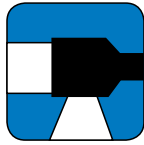

Dualie® 2AA Multi-Function Flashlight

- » Shines both ahead of you and downward
- » Intrinsically safe
- » Features two white LEDs and three modes: spot, flood, spot/flood combo (175 lumens)
- » Two beams that intersect for optimum path illumination and no blind spots
- » Dual head switches on either side of the body for easy beam selection and one-handed operation
- » IPX4 rated; 2m impact resistance tested
- » Integrated magnet on tail end for hands-free use
- » Includes two "AA" alkaline batteries

ITEM #	ORDER #	DESCRIPTION	UOM
67751	342300381	Yellow	EA
67753	342300371	Black	EA



68751



Dualie® 3AA Multi-Function Flashlight

- » Shines both ahead of you and downward
- » Intrinsically safe
- » Features two white LEDs and three modes: spot, flood, spot/flood combo (175 lumens)
- » Two beams that intersect for optimum path illumination and no blind spots
- » Rugged, integrated, snag-free clip
- » Unbreakable polycarbonate face cap and side lens with scratch-resistant coating

ITEM #	ORDER #	DESCRIPTION	UOM
68750	342300361	Yellow - batteries included	EA
68751	342300301	Yellow - w/o batteries	EA
68753	342300261	Black - w/o batteries	EA



68762

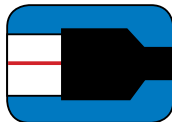

Dualie® 3AA Laser Flashlight

- » Intrinsically safe flashlight with a red laser pointer
- » Target objects at a distance easy with a forward facing LED spot beam and laser pointer
- » Dualie Laser model features one white LED and a 640nm - 650nm red laser and three lighting modes: spot, laser, LED/Laser combo
- » Durable, non-conductive, corrosion-proof polymer resin; rocky stipple texture for a sure grip
- » Unbreakable polycarbonate face cap lens with scratch resistant coating
- » Includes three "AA" alkaline batteries

ITEM #	ORDER #	DESCRIPTION	UOM
68760	342300331	Yellow - Laser	EA
68762	342300321	Black - Laser	EA



68780



Dualie® 3AA Magnetic Clip Flashlight

- » Shines both ahead of you and downward
- » Intrinsically safe
- » Features a magnetic clip with integrated hang hook for hands-free use
- » Features two white LEDs and three modes: spot, flood, spot/flood combo (175 lumens)
- » Two beams that intersect for optimum path illumination and no blind spots
- » Rugged, integrated, snag-free clip
- » Unbreakable polycarbonate face cap and side lens with scratch-resistant coating

ITEM #	ORDER #	DESCRIPTION	UOM
68780	342300351	Yellow - Magnetic Clip	EA
68781	342300341	Black - Magnetic Clip	EA

ProPolymers



67100

2AA ProPolymer® HAZ-LO® Flashlight

- » White LED delivers 65 lumens; 96m beam distance;
- » Impact-resistant engineering polymer construction
- » IPX7; waterproof to 1m for 30 minutes
- » 1m impact resistance tested
- » 6.40 inches in length
- » Powered by 2 "AA" alkaline batteries (included)

ITEM #	ORDER #	DESCRIPTION	UOM
67100	342300311	Black - 2AA ProPolymer	EA
67101	342300291	Yellow - 2AA ProPolymer	EA



2AAA ProPolymer® HAZ-LO® Flashlight

- » LED produces 60 lumens; 800 candela; 57 meter beam distance
- » Impact and chemical-resistant engineering polymer construction
- » IPX4 water-resistant; 1m impact resistance tested
- » 5.40 inches in length
- » Powered by 2 "AAA" alkaline batteries (included)



66505

ITEM #	ORDER #	DESCRIPTION	UOM
66505	342300271	Yellow - 2AAA ProPolymer	EA



4AA ProPolymer® Lux Safety Rated Flashlight

- » LED technology, with a 50,000 hour lifetime
- » Unbreakable polycarbonate lens with scratch-resistant coating
- » 100 lumens typical
- » Rubber-booted, tailend, push-button tailswitch for onehanded operation
- » Non-conductive, Shock resistant (drop test verified)
- » Powered by 4 "AA" alkaline batteries (included)



68244

ITEM #	ORDER #	DESCRIPTION	UOM
68602	342300281	Yellow - Safety Rated Div 1	EA
68244	342300141	Yellow - Safety Rated Div 2	EA

Small Flashlights



Stylus® Pro Pen Light

- » Compact, durable light conveniently fits in your pocket
- » White LED produces 100 lumens; runs 8 hours
- » IPX4 - water-resistant; 2m impact resistance tested
- » Push-button tail switch
- » Durable, anodized machined aircraft aluminum construction
- » Unbreakable polycarbonate lens
- » Powered by 2 "AAA" alkaline batteries (included)



66118

ITEM #	ORDER #	DESCRIPTION	UOM
66118	342300191	Stylus Pro	EA



Small Flashlights



88040

Protac HL® Handheld Flashlight

- » LED technology impervious to shock with a 50,000 hour lifetime
- » Produces a blinding 750 lumen beam on high mode
- » Features three output levels: high, low, strobe
- » Multi-function, push-button tail switch for one-handed operation
- » IPX7 waterproof to 1 meter for 30 minutes
- » 1 meter impact resistance tested
- » Includes two 3V CR123A lithium batteries and nylon holster

ITEM #	ORDER #	DESCRIPTION	UOM
88040	342300151	Tactical Flashlight	EA



Protac® 2AA Flashlight

- » A versatile, pocket sized light with 250 lumens of bright light
- » TEN-TAP® Programming allows selection of three different operating programs
- » IPX7 waterproof to 1m for 30 minutes; 2m impact resistance tested
- » Includes two "AA" alkaline batteries and nylon holster

ITEM #	ORDER #	DESCRIPTION	UOM
88033	342300161	Tactical Pocket Size Light	EA



88033



71500

Streamlight Jr.® LED Flashlight

- » C4® LED delivers 140 lumens; 96m beam distance; runs 5 hours (alkaline)
- » Push button tail switch - momentary or constant on operation
- » Durable, anodized aluminum construction with non-slip knurled grip; unbreakable polycarbonate lens
- » Includes black nylon flapless holster and removable pocket clip
- » Powered by two "AA" alkaline batteries (included)

ITEM #	ORDER #	DESCRIPTION	UOM
71500	342300171	Handheld LED Flashlight	EA



Microstream® Pocket Light

- » Ultra-compact 3.6" design fits in the palm of your hand or comfortably in your pocket
- » White LED delivers 45 lumens; 41m beam; runs 2.25 hours
- » Corrosion-resistant anodized aircraft aluminum construction
- » IPX4 water-resistant
- » Includes one "AAA" alkaline battery and high-strength "break away" safety lanyard

ITEM #	ORDER #	DESCRIPTION	UOM
66318	342300181	Mini LED Flashlight	EA



66318

Headlamps



HDDIN32E

Energizer

Vision HD+Focus LED Headlamp

- » Five LED headlight light modes: high, low, spot, flood, and red for night vision
- » Memory recall feature allows users to quickly access their favorite focus setting the next time the light is activated.
- » Pivoting head to direct headlamp light where needed
- » Powerful headlamp beam. Up to 4X brighter than standard LED technology
- » Water resistant and drop tested
- » Operates on 3 AAA batteries (Included)

ITEM #	ORDER #	DESCRIPTION	UOM
HDDIN32E	217200241	Headlamp	EA



MSHD31BP

Energizer

Intrinsically Safe® 3AA Headlamp

- » Class I Division I rated
- » Light pivots to direct beam where needed
- » Four light modes: high, low, red for night vision, and green for inspection work
- » Flip-up lens diffuses headlamp spot to area light
- » Rear-mount battery pack distributes weight evenly
- » Runtime 15 hours
- » Operates on 3 AAA batteries (Included)

ITEM #	ORDER #	DESCRIPTION	UOM
MSHD31BP	217200211	Headlamp	EA

Work Lights

Energizer

Hard Case® Professional Work Light

- » Rugged polymer and durable over-mold maximize shock absorption
- » Hands free functionality: retractable rotating hook, magnets, wide base
- » Latest LED technology provides clear, bright light for tough jobs
- » High (550 lumens) and Low (150 lumens) modes for brightness
- » Wide angle area light is ideal for projects
- » Operates on 4 AA batteries (Included)

ITEM #	ORDER #	DESCRIPTION	UOM
HCAL41E	217200231	Work Light	EA

⚠ WARNING: Cancer and Reproductive Harm - www.P65Warnings.ca.gov



HCAL41E



TUF2AAPE

Energizer

Hard Case® Professional Task Light

- » Rugged polymer and durable over-mold maximize shock absorption
- » High (300 lumens) and Low (45 lumens) modes for brightness
- » Large push-button switch for easy operation, even with gloves
- » Compact light is easy to carry and store
- » Operates on 2 AAA batteries (Included)

ITEM #	ORDER #	DESCRIPTION	UOM
TUF2AAPE	217200221	Mini LED Flashlight	EA



Small Flashlights



1910



1910 Series

- » Ultra compact aluminum LED flashlight
- » Unconditional lifetime guarantee of excellence
- » Ingress Protected IPX7
- » High/low modes
- » On/off/momentary switch
- » High carbon steel clip
- » Single AAA battery (included)

ITEM #	ORDER #	DESCRIPTION	UOM
1910	548519101	Ultra Compact Black LED Flashlight	EA



1920



1920 Series

- » Compact aluminum LED flashlight
- » Unconditional lifetime guarantee of excellence
- » Ingress Protected IPX7
- » High/low modes
- » On/off/momentary switch
- » High carbon steel clip
- » 2 AAA batteries (included)

ITEM #	ORDER #	DESCRIPTION	UOM
1920	548519201	Compact LED Flashlight	EA

Tactical Light



7000



7000 Series

- » Pocket sized LED tactical light
- » Intense LED output of 774 lumens
- » Four light modes of high/medium/low/strobe
- » 4 programmable combinations
- » Push button switch
- » Nickel plated spring steel clip
- » 2 Lithium-Ion (CR123) batteries (included)

ITEM #	ORDER #	DESCRIPTION	UOM
7000	548500071	Pocket Sized Black LED Tactical Flashlight	EA



7100



7100 Series

- » High performance, compact LED tactical light
- » Intense LED output of nearly 700 lumens
- » Unconditional lifetime guarantee of excellence
- » USB Lithium Ion rechargeable
- » Full time battery level indication
- » Selectable modes - push button switch
- » Four light modes of high/strobe/medium/low
- » Ingress Protected IPX8 Submersible
- » High carbon steel clip

ITEM #	ORDER #	DESCRIPTION	UOM
7100	548501301	Black LED Tactical Flashlight	EA



Headlamps



HeadsUp Lite™ 2690 Series

- » 74 lumens of LED light with 11 hours of battery run time
- » Made of impact and chemical resistant ABS
- » Water resistant for all-weather use
- » One-handed rotary on/off switch
- » 3 AA batteries (included)
- » Class I, Division 1/Class II, Division 1/Class III, Division 1/IECEX ia – Safety Certified
- » IECEX underground mining approved



2690

ITEM #	ORDER #	DESCRIPTION	UOM
2690	548526901	HeadsUp Lite™ Hard Hat Headlamp	EA



2765 Series

- » 105 lumens of LED light with 9 hours and 30 minutes of battery run time
- » Ultra compact and lightweight with three uniquely positioned LEDs
- » Push button switch - high/low/downcast/flashing light modes
- » Full-time battery level indicator
- » 3 AA batteries (included)
- » Class I, Division 1/IECEX ia – Safety Certified



2765

ITEM #	ORDER #	DESCRIPTION	UOM
2765	548500311	Ultra Compact, Lightweight Headlamp	EA

Lantern



360° Sound and Light Lantern

- » Provides 360 degrees of light
- » Built-in Bluetooth® speaker streams music for up to 20 hours
- » USB charging capability keeps battery powered
- » IPX4 water-resistant design
- » Light runtime: 7 hours on high, 16 on medium, 40 on low

ITEM #	ORDER #	DESCRIPTION	UOM
2000033083	623905651	360° Sound and Light Lantern	EA

WARNING: Cancer and Reproductive Harm - www.P65Warnings.ca.gov



2000033083



Lantern

LIGHTING



9410L Series

- » Rechargeable LED lantern is less than 3 pounds and 1203 lumens
- » Four LEDs, powered by the latest generation Lithium-Ion batteries illuminate a distance of 475 yards (435 meters)
- » Battery Level Indicator
- » Push button switch - high/low/flashing light modes
- » Recharge time of 8 hours
- » 6 Lithium-Ion (18650) batteries (included)
- » IPX4 water resistant
- » Approved to NFPA (National Fire Protection Association) 1901



9410L

ITEM #	ORDER #	DESCRIPTION	UOM
9410L	548594101	Rechargeable LED Lantern	EA

Remote Area Lighting Systems



9435



9435 RALS Series

- » Battery powered Remote Area Lighting System (RALS)
- » The fully extendable mast with 360° rotating head fits light in confined or open spaces
- » 1500 lumen output on high setting, 5 hour runtime
- » 750 lumen output on low setting, 10 hour runtime
- » Low battery indicator provides ample warning to recharge
- » 1 NiMH battery (included)
- » Class I Division 2 Groups ABCD T4 - Safety Certified

ITEM #	ORDER #	DESCRIPTION	UOM
9435	548594351	Remote Area Lighting System	EA

Energizer

Ultimate Lithium® Batteries

- » The #1 longest-lasting AA batteries
- » Weighs 1/3 less than standard alkaline batteries
- » Mercury and Cadmium free
- » Guaranteed leak-proof construction (based on standard use)

ITEM #	ORDER #	DESCRIPTION	UOM
L91	217200135	AA	24/PK
L92BP-2	217200265	AAA	2/PK
L522	217200255	9-Volt	12/Pk

Batteries



L91

L92BP-2

L522

Batteries

DURACELL®

Coppertop Alkaline Batteries

- » Duracell® Coppertop batteries are engineered to deliver the power you need for all your professional devices
- » Long lasting, reliable alkaline power
- » Guaranteed for 10 years in storage
- » Available in economical bulk packs

ITEM #	ORDER #	DESCRIPTION	UOM
MN1500BKD	169027535	AA	24/PK
MN2400BKD	169001635	AAA	24/PK
MN1300	169027505	D	12/PK



MN2400BKD



MN1500BKD

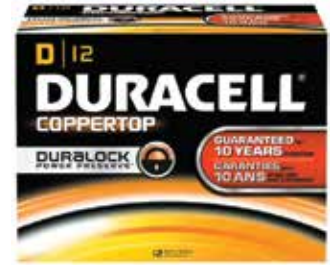

MN1300



PC2400BKD09



PC1500BKD09



PC1400



PC1300



PC1604BKD09

DURACELL®

PROCELL Professional Alkaline Batteries

- » Duracell® PROCELL batteries are economically packaged in bulk and individually date-coded for effective inventory management
- » Manufactured to strict specifications to meet the highest standards of durability, longevity and efficient power
- » Reliable power for hospitals, manufacturing facilities and anywhere else batteries must be frequently replaced

ITEM #	ORDER #	DESCRIPTION	UOM
PC1500BKD09	169021485	AA	24/PK
PC2400BKD09	169036485	AAA	24/PK
PC1400	169018405	C	12/PK
PC1300	169029035	D	12/PK
PC1604BKD09	169027495	9-Volt	12/PK

Energizer

INDUSTRIAL® Alkaline Batteries

- » Economical power for modern devices that demand high power and are heavily used
- » Hold power for up to 10 years in storage
- » Mercury and Cadmium free
- » Available in economical bulk packs

ITEM #	ORDER #	DESCRIPTION	UOM
EN91	373500035	AA	24/Pk
EN92	373500065	AAA	24/Pk
EN93	373500045	C	12/Pk
EN95	373500055	D	12/Pk
EN22	373500015	9-Volt	12/Pk



EN91



EN93



EN92



EN95



EN22

Gas Detectors

Honeywell

ToxiPro® Single Gas Detectors

- » Small, lightweight design
- » Robust, shock-resistant housing
- » Fully illuminated backlit LCD
- » Continuous, real-time gas readings
- » Max, STEL and TWA readings
- » Highly visible bright LED visual alarms (red and yellow)
- » IP66/67 rating
- » Automatic black box datalogger

Approvals:

- UL Class I, Div 1, Group A,B,C,D T4
- UL Class II, Div 1, Group E,F,G
- CSA Class I, Div 1, Group A,B,C,D T4
- CSA Class II, Div 1, Group E,F,G
- ATEX (DEMKO) II 1 G Ex ia IIC T4
- IECEx Ex ia IIC T4 Ga
- CE Mark
- CQST (China) Ex ia IIC T4



54-45-90V

ITEM #	ORDER #	DESCRIPTION	UOM
54-45-02V	C23545041	Single Gas H ₂ S	EA
54-45-13V	C23545131	Single Gas PH ₃	EA
54-45-21V	C23545221	Single Gas NH ₃	EA
54-45-90V	C23545911	Single Gas O ₂	EA



10092521



ALTAIR® Single-Gas Detector

- » Survives multiple 20' drops onto concrete
- » Waterproof and dustproof (third-party certified IP67)
- » 2-year warranty is never pro-rated
- » Can be calibrated if it fails a bump test
- » Does not automatically shutdown when 24-month clock runs out
- » Datalog provides up to 25-event records

ITEM #	ORDER #	INSTRUMENT TYPE	FIRST ALARM	SECOND ALARM	UOM
10092521	3085885B1	Hydrogen Sulfide (H ₂ S)	10 PPM	15 PPM	EA
10092522	3085617D1	Carbon Monoxide (CO)	25 PPM	100 PPM	EA
10092523	3085157D1	Oxygen (O ₂)	19.5% VOL	23% VOL	EA



ALTAIR® 2X Gas Detector

- » Withstands extreme impacts with rugged polycarbonate housing and passes 25-foot drop test
- » IP 67-rated Altair 2X is both dust tight and water tight
- » Minimal radio frequency interference
- » Full three-year warranty supports the entire instrument, including the sensors



10154040

ITEM #	ORDER #	DESCRIPTION	COLOR	UOM
10153984	308539841	2XP with Xcell Pulse Technology: H ₂ S-Pulse (10, 15)	Charcoal	EA
10154040	308500991	2XT Two-TOX Gas Detector: CO/H ₂ S (CO: 25, 100; H ₂ S: 10, 15)	Charcoal	EA
10154181	308501381	2XT Two-TOX Gas Detector: CO/H ₂ S (CO: 25, 100; H ₂ S: 10, 15)	Phosphorescent	EA

Multigas Detectors



10178557



ALTAIR 4XR Multigas Detector

- » <15-second sensor response time
- » Four-year warranty, five-year expected life
- » 24-hour run-time
- » IP68 rating
- » Survives incidental 25-ft. drops, exceeds MIL-STD-810 drop test requirements
- » Bluetooth connectivity and event notification

ITEM #	ORDER #	INSTRUMENT TYPE	UOM
10178557	308511071	Multigas Detector (LEL, O ₂ , CO, H ₂ S), Charcoal	EA



ALTAIR 5X Multigas Detector

- » High-resolution color or monochrome LCD display with multilingual capabilities
- » MSA's Logo Express® Service can customize color display
- » Configurable detectors with interchangeable plug-and-play sensor slots can monitor as many as six gases simultaneously
- » Optional glow-in-the-dark instrument housing for IR sensor-equipped units
- » 20* hour lithium-ion battery; alkaline battery pack also available
- » Fully compatible with the MSA GALAXY® GX2 Automated Test System and MSA Link™ Software



10116926

ITEM #	ORDER #	INSTRUMENT TYPE	UOM
10116926	3085842D1	Monochrome Display, 10-ft. Sampling Line, 1-ft. Probe: (LEL, O ₂ , CO, H ₂ S)	EA
10116928	3085686D1	Color Display, 10-ft. Sampling Line, 1-ft. Probe: (LEL, O ₂ , CO, H ₂ S)	EA

Gas Detectors



10128642



GALAXY GX2 Automated Test System

- » Color touch screen for ease of setup and viewing
- » Extremely simple to use; testing starts automatically without touching a single button
- » Simultaneous testing of up to ten instruments
- » Galaxy GX2 system is optimized for use with MSA's XCell® sensors
- » At-a-glance indicators include low calibration gas volume, expiration warnings and test stand status
- » MSA link pro software provides proactive safety management, dashboard overview and total record-keeping
- » 18 languages available for test stand and MSA link pro software that simplifies usage and reduces training

ITEM #	ORDER #	DESCRIPTION	UOM
10128642	3085303E1	4/4X Multigas Detector: 1 Valve (for Use with 1 Calibration Gas Cylinder)	EA
10128628	308586291	5/5X Multigas Detector: 1 Valve (for Use with 1 Calibration Gas Cylinder)	EA



Econo-Cal® Calibration Cylinders

- » 34 Liter
- » Contents are at 500 psig
- » Aluminum cylinders



711058



467897

10045035



RP Calibration Cylinders

- » 58 Liter
- » Contents are at 500 psig
- » Aluminum cylinders

ITEM #	ORDER #	DESCRIPTION	UOM
711058	30851058	Multi-Gas Cylinder: 1.45% Methane, CO 300 ppm, O ₂ 15%, H ₂ S 10 ppm, Balance N	EA
10048280	30858280	Multi-Gas Cylinder: 1.45% Methane, CO 60 ppm, O ₂ 15%, H ₂ S 20 ppm, Balance N	EA

ITEM #	ORDER #	DESCRIPTION	UOM
467897	308551731	Single Gas (H ₂ S) 40 ppm	EA
804770	30854770	Multi-Gas Cylinder: 1.45% Methane, CO 300 ppm, O ₂ 15%, H ₂ S 10 ppm, Balance N	EA
10045035	308535101	Multi-Gas Cylinder: 1.45% Methane, CO 60 ppm, O ₂ 15%, H ₂ S 20 ppm, Balance N	EA

Gas Detectors



Gas Miser® Regulator

- » Use with RP and Econo-Cal calibration cylinders
- » Can supply gas flow from 0.1 - 3.0 lpm
- » Comes with calibration tubing and special adapter fitting

ITEM #	ORDER #	DESCRIPTION	UOM
710288	308586011	Miser Gas Regulator	EA



710288



Model RP Calibration Check Kit

Includes:

- » Regulator (0.25 lpm)
- » Tubing, 30" (without sampling line connection)
- » Calibration Cap: ALTAIR 4/4X
- » Fitting, Quick Disconnect
- » Zero plug for MSA electrochemical sensors
- » Fitting, Quick Disconnect, Internal, 3/16 Barb



477149

ITEM #	ORDER #	DESCRIPTION	UOM
477149	30857149	Model RP, with 0.25 lpm Regulator	EA



Model RP Fixed Flow Regulator

- » Regulator threads onto into 34, 58 and 116 L aluminum bottles and 100 L steel bottles
- » Limited to 1000 psi

ITEM #	ORDER #	DESCRIPTION	UOM
467895	30857895	Regulator with 0.25 lpm	EA



467895



Confined Space

CONFINED SPACE



9543



9543-15

Ships Direct **FOB Mfg.**



12" Plastic Axial Blower with Canister and Ducting

- » UV-, corrosion- and chemical-resistant polyethylene in "safety orange"
- » Canister attaches to intake or output of blower for suction or ventilation
- » Molded carry handle
- » 1 HP, 115/230V, 50/60Hz, 11A, 3400 RPM

Flow rates*:

- Free air: 1842 CFM
- One 90° bend: 1004 CFM
- Two 90° bends: 933 CFM
- » Certifications: UL Listed, CSA Certified Standard C22.2 No.113, CE Certified

ITEM #	ORDER #	DESCRIPTION	UOM
9543	33429543	Blower Only	EA
9543-15	33429544	Blower with Canister and 15' Ducting	EA
9543-25	33429545	Blower with Canister and 25' Ducting	EA



16" Plastic Axial Blower with Canister and Ducting

- » UV-, corrosion- and chemical-resistant polyethylene in "safety orange"
- » Canister attaches to intake or output of blower for suction or ventilation
- » Molded carry handle
- » 1 HP, 115V/60Hz, 9A, 3450 RPM

Flow rates*:

- Free air: 3200 CFM
- One 90° bend: 2350 CFM
- Two 90° bends: 2250 CFM
- » Certifications: UL Listed, CSA Certified Standard C22.2 No.113

Ships Direct **FOB Mfg.**



9553



9553-15

ITEM #	ORDER #	DESCRIPTION	UOM
9553	334205841	Blower Only	EA
9553-15	334205851	Blower with Canister and 15' Ducting	EA
9553-25	334205861	Blower with Canister and 25' Ducting	EA



16" Ventilation Axial Blower

- » Complete unit epoxy powder coated in "safety orange"
- » Interchangeable flange for intake/exhaust side mounting
- » 18-gauge cold rolled steel housing
- » Integrated carrying handles
- » Equipped with four rubber feet
- » Certifications: CSA Certified Standard C22.2 No.113, UL Listed

Ships Direct **FOB Mfg.**



9515



9515-01

ITEM #	ORDER #	DESCRIPTION	MOTOR	FREE AIR*	ONE 90** BEND	TWO 90** BENDS	UOM
9515	334203291	Standard Blower	1/2 HP, 115V/60Hz, 7.2A, 1725 RPM	3400 CFM	2800 CFM	2300 CFM	EA
9516	334203321	High Output Blower	2 HP, 115/230V, 60Hz, 21/10.5A, 3450 RPM	5500 CFM	4950 CFM	4400 CFM	EA
9515-01	334203311	Explosion-Proof Blower	1/2 HP, 115/230V, 60Hz, 8.2/4.1A, 1725 RPM	2900 CFM	1800 CFM	1750 CFM	EA

Confined Space



20" Ventilation Axial Blower

- » Complete unit epoxy powder coated in "safety orange"
- » Interchangeable flange for intake/exhaust side mounting
- » 16-gauge cold rolled steel housing
- » Integrated carrying handles
- » Equipped with four rubber feet
- » Certifications: CSA Certified Standard C22.2 No.113, UL Listed

Ships Direct FOB Mfg.



ITEM #	ORDER #	DESCRIPTION	MOTOR	FREE AIR*	ONE 90** BEND	TWO 90** BENDS	UOM
9525	33429525	Standard Blower	1/2 HP, 115V/60Hz, 7.2A, 1725 RPM	4650 CFM	3150 CFM	2950 CFM	EA
9525-50	33422550	High Output Blower	2 HP, 115/230V, 60Hz, 21/10.5A, 3450 RPM	7500 CFM	6700 CFM	6130 CFM	EA
9525-01	33422501	Explosion-Proof Blower	1/2 HP, 115/230V, 60Hz, 8.2/4.1A, 1725 RPM	4650 CFM	3150 CFM	2950 CFM	EA



8" Plastic COM-PAX-IAL Blowers

- » 9533-15 and 9533-25 models are the lightest and smallest in the industry
- » UV-, corrosion- and chemical-resistant polyethylene in "safety orange"
- » Bottom enclosure to protect electrical component
- » Carry handle molded into blower and canister housing
- » Steel powder coated grill
- » Certifications - CE Certified, CSA Certified Standard C22.2 No.113, UL Listed



Ships Direct FOB Mfg.

ITEM #	ORDER #	DESCRIPTION	FREE AIR*	ONE 90** BEND	TWO 90** BENDS	UOM
1/3 HP, 115/230V, 50/60Hz, 4.8/2.4A, 3400 RPM						
9533	334203461	AC Blower Only	831 CFM	709 CFM	586 CFM	EA
9533-15	334203481	AC Blower with Canister and 15' Ducting	831 CFM	709 CFM	586 CFM	EA
9533-25	334203491	AC Blower with Canister and 25' Ducting	831 CFM	709 CFM	586 CFM	EA
1/4 HP, 12V DC, 22A, 3800 RPM						
9536	334203561	DC Blower Only	816 CFM	526 CFM	442 CFM	EA
9536-15	334203571	DC Blower with Canister and 15' Ducting	816 CFM	526 CFM	442 CFM	EA
9536-25	334203581	DC Blower with Canister and 25' Ducting	816 CFM	526 CFM	442 CFM	EA
1/3 HP, 115/60Hz, 2.2A, 3250 RPM						
9538	334295381	Explosion Proof Blower Only	900 CFM	650 CFM	625 CFM	EA
9538-15	33423815	Explosion Proof Blower with Canister and 15' Ducting	900 CFM	650 CFM	625 CFM	EA
9538-25	33423825	Explosion Proof Blower with Canister and 25' Ducting	900 CFM	650 CFM	625 CFM	EA



8" Axial Blowers with Canister and Ducting

- » Design allows ducting to collapse into a built-in canister
- » Unit can be stored vertically
- » 1/3 HP, 120V/60Hz, 3A, 3200 RPM
- » 18-gauge cold rolled steel housing
- » 14-gauge steel enclosed panel to protect electrical components

Flow rates*:

- Free air: 1275 CFM
- One 90° bend: 661 CFM
- Two 90° bends: 582 CFM
- » Certified to CSA STD C22.2 No 113, UL Listed
- » Air delivery certified CEESI

Ships Direct FOB Mfg.



ITEM #	ORDER #	DESCRIPTION	UOM
9514	334203231	Includes 15' Ducting	EA
9514-25	334203271	Includes 25' Ducting	EA



Confined Space



Air Bag Blowers with Ducting

- » Blower system with ducting built into heavy duty bag
- » Carry handle with molded-in 2-speed switch
- » Steel/powder coated housing and grills
- » Unique bag with openings for plug/cord, inlet and outlet
- » 15' duct mounted on the blower and stored inside bag
- » Both carrying handle and shoulder strap allows for easy transportation

Ships Direct FOB Mfg.



9535-08

ITEM #	ORDER #	DESCRIPTION	MOTOR	FREE AIR*	UOM
9535-08	334205381	8" System	1/4 HP, 120V/60Hz, 1.4A, 3300 RPM	760 CFM	EA
9535-12	334235121	12" System	1/2 HP, 120V/60Hz, 3.8A, 3300 RPM	1840 CFM	EA



9401-25



Ships Direct FOB Mfg.

Magnetic Manhole Lid Lifters

- » Lift heavy manhole lids alone
- » Clamps to cover without any special tools
- » Eliminates the use of pry bars
- » For safety must be in contact with the cover to be engaged
- » Collapsible for easy storage and transportation

ITEM #	ORDER #	DESCRIPTION	UOM
9401-25	33422127	Steel Dolly and Magnet (Lift Weight: 660 lbs. Flat Items, 330 lbs. Round Items)	EA
9401-25A	33422129	Aluminum Dolly and HD Magnet (Lift Weight: 660 lbs. Flat Items, 330 lbs. Round Items)	EA
9401-26A	33422130	Aluminum Dolly and HD Magnet (Lift Weight: 900 lbs. Flat Items, 450 lbs. Round Items)	EA



9401-20



Manhole Accessories

Ships Direct FOB Mfg.

Guard Rail

- » Designed to protect an area of 33"L x 33"W
- » Support arm gives guardrail added support
- » Two chains with hook for additional security
- » 2 welded marker flags
- » Simple one-piece construction assembles without tools
- » Collapses to 44"L x 32"W x 4"H for compact storage

High Impact Manhole Shield

- » Bright yellow material that resists fading
- » Fits 28", 30" and 32" diameter manholes
- » Inflatable watertight seal
- » 4-outrigger support gussets that stabilize the shield
- » 12" tall to keep water and mud out of manhole

Hook Manhole Lifter

- » 21" heat treated, cadmium-plated all steel alloy hook
- » Lockable hook for convenient storage
- » Rubber grip on handle, rubber foot to minimize slippage
- » Support leg angled 6" for leverage



9401

9401-12

ITEM #	ORDER #	DESCRIPTION	UOM
9401	334202661	Guard Rail	EA
9401-12	334202681	Plastic Shield	EA
9401-20	334202691	Steel, Hook Lifter	EA



Beverages



EverLyte™ Pouch

- » 8 oz. ready to drink pouch
- » Quick and convenient
- » Clear – No added Color/Dyes
- » No preservatives
- » No artificial sweeteners
- » Less calories and sugar than regular Squincher®
- » 24/CS



030860-FP



030861-GR

ITEM #	ORDER #	DESCRIPTION	UOM
159030860	33170156	Fruit Punch	CS
159030861	33170157	Grape	CS



Powder Pack™

- » Quick and easy to mix
- » 3 step cooler ready: add water, add Powder Pack and stir



159016040



159016400

ITEM #	ORDER #	DESCRIPTION	UOM
23.83 oz. Concentrate Yields 2.5 Gal – 32/CS			

159016040	33174854	Lemonade	CS
159016041	33174856	Orange	CS
159016042	33174857	Fruit Punch	CS
159016043	33174858	Lemon-Lime	CS
159016044	33170030	Assorted Flavors	CS
159016045	33170031	Tea	CS
159016046	33174855	Grape	CS
159016047	33170032	Cherry	CS
159016048	33170033	Mixed Berry	CS
159016049	33170034	Tropical Cooler	CS
159016050	33170035	Cool Citrus	CS

ITEM #	ORDER #	DESCRIPTION	UOM
47.66 oz. Concentrate Yields 5 Gal – 16/CS			

159016400	33170036	Mixed Berry	CS
159016401	33170037	Cherry	CS
159016402	33170038	Cool Citrus	CS
159016403	33170039	Lemonade	CS
159016404	33170040	Orange	CS
159016405	33170041	Fruit Punch	CS
159016406	33170042	Grape	CS
159016408	33170043	Lemon-Lime	CS
159016409	33170044	Tropical Cooler	CS



Powder Pack™ EverLyte™

- » Squincher EverLyte™ is formulated in-between regular Squincher and Squincher ZERO with only 40 calories per 8 oz. serving
- » EverLyte™ maintains the taste expected from standard
- » 19.1 oz. concentrate yields 3 Gal, quick and easy to mix
- » 3 step cooler ready: add water, add Powder Pack and stir
- » 20/CS



159016870

ITEM #	ORDER #	DESCRIPTION	UOM
159016870	33176806	Grape	CS
159016871	33176807	Orange	CS
159016872	33176808	Fruit Punch	CS
159016873	33176809	Lemon-Lime	CS



Beverages

HEAT STRESS



Liquid Concentrate

- » Liquid concentrates mix easily with water
- » Low sodium beverage
- » No stirring required

ITEM #	ORDER #	DESCRIPTION	UOM
64 oz. Concentrate Yields 5 Gal – 6/CS			
159030319	33170319	Strawberry Lemonade	CS
159030320	33170055	Mixed Berry	CS
159030321	33170056	Cherry	CS
159030322	33178663	Grape	CS
159030323	33178662	Lemonade	CS
159030324	33178664	Orange	CS
159030325	33178665	Fruit Punch	CS
159030328	33178666	Lemon-Lime	CS
159030329	33170058	Tropical Cooler	CS
159030330	33170059	Cool Citrus	CS



159030319



Single Serve EverLyte™ Sticks

- » 1 oz. of powder mix yields 16.9 to 20 oz.
- » Naturally sweetened
- » Naturally flavored
- » No added color or dyes
- » Low calorie
- » 8/BG



159060280

ITEM #	ORDER #	DESCRIPTION	UOM
159060280	331768105	Grape	BG
159060281	331768115	Orange	BG
159060282	331768125	Fruit Punch	BG
159060283	331768135	Lemon-Lime	BG



Single Serve QwikServ™

- » 1.2 oz. concentrate yields 16.9 oz.
- » Convenient and personal
- » Great for hydration on-the-go
- » Easy to store and pack
- » 8/BG



159060900

ITEM #	ORDER #	DESCRIPTION	UOM
159060900	331709005	Orange	BG
159060901	331709015	Fruit Punch	BG
159060902	331709025	Lemon-Lime	BG
159060904	331709045	Grape	BG



Single Serve Qwik Stik™ ZERO

- » 0.11 oz. concentrate yields 20 oz.
- » No carb, sugar-free electrolyte replenishment formula
- » 50/BG



159060099

ITEM #	ORDER #	DESCRIPTION	UOM
159060099	331760995	Strawberry Lemonade	BG
159060100	331701195	Orange	BG
159060101	331701205	Mixed Berry	BG
159060102	331701215	Fruit Punch	BG
159060103	331701225	Lemonade	BG
159060098	331701645	Lemonade Tea	BG

ITEM #	ORDER #	DESCRIPTION	UOM
159060097	331701655	Watermelon	BG
159060106	331711065	Lemon-Lime	BG
159060107	331711075	Grape	BG
159060109	331711095	Cool Citrus	BG
159060119	33176119	Assorted	200/CS



Beverages



Single Serve Fast Pack® ZERO

- » 0.6 oz. concentrate yields 6 oz.
- » No carb, sugar-free electrolyte replenishment formula
- » 200/CS



159015500

ITEM #	ORDER #	DESCRIPTION	UOM
159015500	33170017	Orange	CS
159015501	33170018	Fruit Punch	CS



Liquid Concentrate ZERO

- » Sugar free
- » 64 oz. concentrate yields 5 Gal
- » Can be mixed in individual cups or pre-mixed to make a large amount
- » No stirring required
- » 6/CS



159050102

ITEM #	ORDER #	DESCRIPTION	UOM
159050102	33170098	Fruit Punch	CS
159050103	33170099	Grape	CS
159050104	33170100	Lemon-Lime	CS
159050106	33170102	Mixed Berry	CS
159050107	33170103	Orange	CS



Squeeze Freezer Pops

- » Freeze and serve
- » Quickly cools body temperature
- » Healthier than frozen sugar ice by replenishing electrolytes
- » Convenient option when on-the-go
- » ZERO freezer pops are Sugar Free
- » 3 oz. single-serve application
- » 150/CS



159200201

ITEM #	ORDER #	DESCRIPTION	UOM
159200201	33170128	Assorted Flavors: Cherry, Grape, Lemon-Lime, Orange and Mixed Berry	CS
159200231	33170168	ZERO Assorted Flavors: Punch, Orange, Watermelon, Dragon Fruit and Mixed Berry	CS



Single Fast Pack®

- » 0.6 oz. concentrate makes a 6 oz. drink
- » Package doubles as a drinking cup
- » Sanitary delivery method prevents contamination
- » No mixing required – just add water
- » No cups required
- » Single serve allows minimal waste
- » Convenient option when on-the-go
- » 200/CS



159015300

ITEM #	ORDER #	DESCRIPTION	UOM
159015300	33170007	Mixed Berry	CS
159015301	33170008	Cherry	CS
159015302	33170009	Grape	CS
159015303	33170010	Lemonade	CS
159015304	33170011	Orange	CS
159015305	33170012	Fruit Punch	CS
159015306	33170013	Tea	CS
159015308	33170014	Lemon-Lime	CS
159015309	33170015	Tropical Cooler	CS
159015310	33170016	Cool Citrus	CS



Beverages



Sqwincer Product Accessories

- » Industrial style, large push-button spout makes dispensing quick and easy
- » Screw-top lid stays secure on your adventures
- » A wide array of accessories from cups to coolers
- » Wide-mouth top for easy filling, especially with ice
- » Low CO₂ insulation for reduced carbon emissions from foam manufacturing



200101



205200



158400104

ITEM #	ORDER #	DESCRIPTION	UOM
158200101	33170129	12 oz. Sqwincer Cups/20 Tubes of 100	CS
158205200	331752001	Universal Plastic Cup Dispenser w/Wall Mount Bracket	EA
158400104	331701331	5 Gal Cooler with Blue Screw on Lid	EA

HEAT STRESS



3000001017



1/2 Gal Beverage Cooler

- » Flip spout makes it easy to grab a drink then securely close your beverage cooler
- » Screw-top lid stays secure on your adventures
- » Bail handle allows for easy carrying with just one hand
- » Wide-mouth top for easy filling, especially with ice

ITEM #	ORDER #	DESCRIPTION	UOM
3000001017	623910171	Red	EA



3000004064



5 Gal Beverage Cooler

- » OSHA jobsite compliant
- » Antimicrobial liner resists odor, mold, mildew and fungus on the product
- » Attached cup dispenser
- » Oversized, comfort-grip handles for easy, controlled lifting and carrying
- » Tethered, screw-top lid stays secure when closed
- » Easy-use faucet lets you conveniently fill your drink

ITEM #	ORDER #	DESCRIPTION	UOM
3000004064	623905101	5 Gal OSHA Cooler	EA



3-Piece Cooler Combo

54 Qt Cooler

- Keeps the Ice![™] - 3-day ice retention at temperatures up to 90°F
- Holds 63 cans
- Leak-resistant channel drain for easy draining without tilting the cooler
- Hinged lid for easy, one-handed access

5 Qt FlipLid[™] Cooler

- Holds 6 cans
- FlipLid[™] reversible hinged lid turns this cooler into a mini table
- Bail handle allows for easy carrying with just one hand
- EZ-Clean top uses a smoother surface that easily wipes clean

1/3 Gal Beverage Cooler

- Flip open cap makes it easy to grab a drink
- Screw-top lid stays secure on your adventures
- Bail handle allows for easy carrying with just one hand

ITEM #	ORDER #	DESCRIPTION	UOM
5295A780G	623904861	Blue	ST



5295A780G



Seasonal Protection



12641

Chill-Its® 6660 Hard Hat Brim with Shade

- » Universal design - elastic inner rim to fit most hard hats
- » Provides sun and UV protection on the face and neck
- » Patented
- » 100% Polyester fabric

ITEM #	ORDER #	DESCRIPTION	UOM
12640	332101651	Hi-Vis Lime	EA
12641	332101661	Hi-Vis Orange	EA



Chill-Its® 6602 Evaporative Cooling Towel



12420

- » Advanced PVA cooling technology
- » Super-evaporative, feels significantly cooler than ambient air
- » Activates fast and easy just run under water
- » Wear for hours or for quick relief
- » Simply re-wet to reactivate
- » Machine washable

ITEM #	ORDER #	DESCRIPTION	UOM
12420	332107341	Size: 13" x 29.5"	EA



940-WAV

Miracool® Neck Bandana

- » New lightweight design with the same cooling power and all of the comfort of 100% cotton

ITEM #	ORDER #	DESCRIPTION	UOM
940-12	325305081	Assorted	EA
940-WAV	325305091	Wavy Flag	EA



Miracool® Heat Stress Prevention Products

- » Exceptional cooling power
- » Lightweight super-absorbent material holds water without weighing you down
- » Helps reduce the cause of heat stress



935-BL



931-BL

ITEM #	ORDER #	DESCRIPTION	UOM
930-BL	325309301	Cooling Neck Wrap, 31.5"L x 4"W	EA
931-BL	325309391	Cooling Towel, 29.5"L x 14"W	EA
932-BL	325319321	PVA Bandana, Adjustable Slit Closure	EA
935-BL	325319351	Snap-On Hard Hat Sweatband Attaches with Snaps	EA
936-BL	325319365	PVA Sweatbands	PK

WARNING: Cancer and Reproductive Harm - www.P65Warnings.ca.gov



Tuff & Dry® Wicking and Cooling

- » Chemical-Free Cooling™ fabric technology
- » Wicks and cools with or without water
- » Activates instantly; snap when wet
- » 23% more cooling power than microfiber
- » 30% cooler than skin when wet

ITEM #	ORDER #	DESCRIPTION	UOM
TD200-018	325310261	Blue Skull Cap	EA
TD300-018	325310301	Blue Bandana 22.5" x 22.5"	EA
TD400-018	325310331	Blue Towel, 26"L x 8"W	EA



TD200-HVY



TD300-018



TD400-018



First Aid - Class A



K615-011

Class A First Aid Kits

- » Designed for common workplace injuries
- » Meets ANSI/ISEA Z308.1-2015 requirements

ITEM #	ORDER #	DESCRIPTION	UOM
K615-011	328000031	16PW First Aid Kit Plastic Case	EA
K615-015	328000041	18M First Aid Kit Metal Case	EA

DESCRIPTION	Size	Pieces
Certi-Strips - Plastic	1" x 3"	16/unit
Triangular Bandage - w /Pins	40" x 40" x 56"	3/unit
Certi-Gauze Pads	3" x 3"	4/unit
Certi-Sporyn - Antibiotic Cream	1g	10/unit
Antiseptic Towelettes	5" x 7"	10/unit
Hand Sanitizer	1g	10/unit
Certi-Tape	½" x 2-½ yd	2/unit
Eye Pads-4 & Certi-Tape-4	Oval/Strips	8/unit
Certi-Burn Cream	1g	10/unit
Gloves - Nitrile - Powder Free	Large	2/pair
CPRotector® - Plastic Bag	5.5" sq	1
Water Jel Burn Dressing	4" x 4"	1
Cold Pack - Certi-Cool Junior	5" x 7"	1
Eye Wash	1 oz	1
Certi-Gauze Roll	2" x 6 yd	1
Scissors - Bandage - Red Handle	4"	1
Trauma Pad - Compress	5" x 9"	1
First Aid Facts Guide	Book	1



K615-012

Class A First Aid Kits - Metal Detectable

- » Bandages are blue metal detectable for food processing and hospitality environments
- » Designed for common workplace injuries
- » Meets ANSI/ISEA Z308.1-2015 requirements

ITEM #	ORDER #	DESCRIPTION	UOM
K615-012	328000171	18PN Class A Blue Metal Detectable	EA
KR616-060	328000351	18PN Class A Blue Metal Detectable Refill	EA

DESCRIPTION	Size	Pieces
Certi-Strips - Woven - BMD	1" x 3"	16/unit
Triangular Bandage - w /Pins	40" x 40" x 56"	3/unit
Certi-Gauze Pads	3" x 3"	4/unit
Certi-Sporyn - Antibiotic Cream	1g	10/unit
Antiseptic Towelettes	5" x 7"	10/unit
Hand Sanitizer	1g	10/unit
Eye Pads-4 & Certi-Tape-4	Oval/Strips	8/unit
Certi-Tape	½" x 2-½ yd	2/unit
Certi-Burn Cream	1g	10/unit
Gloves - Nitrile - Powder Free	Large	2/pair
CPRotector® - Plastic Bag	5.5" sq	1
Water Jel Burn Dressing	4" x 4"	1
Cold Pack - Certi-Cool Junior	5" x 7"	1
Eye Wash	1 oz	1
Certi-Gauze Roll	2" x 6 yd	1
Scissors - Bandage - Red Handle	4"	1
Trauma Pad - Compress	5" x 9"	1
First Aid Facts Guide	Book	1



First Aid - Class A



K616-015

Class A Office - 3 Shelf Metal Cabinet

- » Designed for common office workplace injuries
- » Medicinals for common workplace ailments: cough, congestion, headache, muscle aches and stomach pain
- » Meets ANSI/ISEA Z308.1-2015 requirements

ITEM #	ORDER #	DESCRIPTION	UOM
K616-015	328000141	75V Class A Office Cabinet	EA
KR616-015	328000311	75V Class A Office Cabinet Refill	EA

DESCRIPTION	Size	Pieces
Certi-Profen Tablets - Ibuprofen	2/pkg	25/box
Certi-Antacid - Calcium Carbonate 420mg	2/pkg	25/box
Certi-Cet Plus Tablets - Non-Aspirin-X-Strength	2/pkg	25/box
Cold-Plus Tablets	2/pkg	25/box
Certi-Ache - Analgesic	2/pkg	25/box
WoundSeal	Tube	2
Cold Pack - Certi-Cool Junior	5" x 7"	1
Gloves - Nitrile - Powder Free	Large	2/pair
Certi-Burn Cream	1g	10/unit
Eye Pads-4 & Certi-Tape-4	Oval/Strips	8/unit
Certi-Tape	½" x 2-½ yd	2/unit
Hand Sanitizer	1g	10/unit
Antiseptic Towelettes	5" x 7"	10/unit
Certi-Sporyn - Antibiotic Cream	1g	10/unit
Certi-Stopper - XL-TD	4" x 60"	1
Burn Dressing	4" x 4"	1
Trauma Pad - Compress	5" x 9"	1
CPRotector® - Plastic Bag	5.5" sq	1
Eye Wash	4 oz	1
Certi-Strips - Woven	Knuckle	8/unit
Certi-Strips - Woven	Fingertip	10/unit
Certi-Gauze Pad	3" x 3"	4/unit
Triangular Bandage - w /Pins	40" x 40" x 56"	3/unit
Certi-Gauze Rolls	2" x 6 yd	2/unit
Certi-Non-Stick Pads	2" x 3"	4/unit
Certi-Strips - Plastic - Junior	½" x 2-¼"	40/unit
Certi-Strips - Plastic	1" x 3"	16/unit
First Aid Facts Guide	Book	1



K615-021

Class A First Aid - 3 Shelf Metal Cabinet

- » Designed for common workplace injuries
- » Meets ANSI/ISEA Z308.1-2015 requirements

ITEM #	ORDER #	DESCRIPTION	UOM
K615-021	328000071	75V First Aid Cabinet	EA
KR615-021	328000281	75V First Aid Cabinet Refill	EA

DESCRIPTION	Size	Pieces
Antiseptic Towelettes	5" x 7"	25/box
Certi-Sporyn - Antibiotic Cream	1g	25/box
Eye Wash	1 oz	1
Certi-Rip - Elastic Cohesive Bandage - Tan	2" x 5 yd	1
CPRotector® - Plastic Bag	5.5" sq	1
Certi-Strips - Plastic	1" x 3"	50/box
Certi-Strips - Woven	Knuckle	25/box
Certi-Strips - Woven	Fingertip	25/box
Certi-Gauze Pads	3" x 3"	10/box
HSB-BloodBorne Pathogen Economy	HSB	1
Cold Pack - Certi-Cool Junior	5" x 7"	1
Cotton Swabs	3"	100/pkg
Certi-Strips - Plastic	2" x 3"	6/unit
Certi-Non-Stick Pads	2" x 3"	4/unit
Certi-Gauze Rolls	2" x 6 yd	2/unit
Certi-Gauze Roll	4" x 6 yd	1/unit
Triangular Bandage - w /Pins	40" x 40" x 56"	3/unit
Certi-Tape	½" x 2-½ yd	2/unit
Eye Pads-4 & Certi-Tape-4	Oval/Strips	8/unit
Insect Sting Wipe-Ups	1" x 2"	10/unit
Tourniquet & Scissors & Forceps	Assortment	3/unit
Hand Sanitizer	1g	10/unit
Certi-Burn Cream	1g	10/unit
Gloves - Nitrile - Powder Free	Large	2/pair
Water Jel Burn Dressing	4" x 4"	1
Certi-Stopper - XL-TD	4" x 60"	1
Trauma Pad - Compress	5" x 9"	1
WoundSeal	Tube	2
First Aid Facts Guide	Book	1



First Aid - Class A

DESCRIPTION	Size	Pieces
Certi-Strips - Plastic	1" x 3"	16/unit
Certi-Non-Stick Pads	2" x 3"	4/unit
Triangular Bandage - w/Pins	40" x 40" x 56"	3/unit
Certi-Gauze Pads	3" x 3"	4/unit
Certi-Sporyn - Antibiotic Cream	1g	10/unit
Antiseptic Towelettes	5" x 7"	10/unit
Certi-Tape	½" x 2-½ yd	2/unit
Eye Pads-4 & Certi-Tape-4 Hand	Oval/Strips	8/unit
Sanitizer	1g	6/unit
Water Jel Cool Jel	1/8 oz	6/unit
Gloves - Nitrile - Powder Free	Large	2/pair
CPRotector® - Plastic Bag	5.5" sq	1
Cold Pack - Certi-Cool Junior	5" x 7"	1
Eye Wash	1 oz	1
Certi-Gauze Roll	2" x 6 yd	1
Scissors - Bandage - Red Handle	4"	1
Trauma Pad - Compress Rescue	5" x 9"	1
Blanket - Silver	52" x 84"	1
Water Jel Burn Dressing	4" x 16"	1
Water Jel Burn Dressing	4" x 4"	1
First Aid Facts Guide	Book	1



K615-017

Class A First Aid Kits - Burn Relief

- » Water-Jel burn dressings provide fast, one-step relief for emergency first aid when someone has been burned
- » Meets ANSI/ISEA Z308.1-2015 requirements

ITEM #	ORDER #	DESCRIPTION	UOM
K616-017	328000131	18PN Class A Burn	EA
KR616-062	328000341	18PN Class A Burn Refill	EA

First Aid - Class B

DESCRIPTION	Size	Pieces
Certi-Strips - Plastic	1" x 3"	16/unit
Certi-Gauze Rolls	2" x 6 yd	2/unit
Certi-Gauze Roll	4" x 6 yd	1/unit
Triangular Bandage - w/Pins	40" x 40" x 56"	3/unit
Certi-Gauze Pads	3" x 3"	4/unit
Antiseptic Towelettes	5" x 7"	10/unit
Hand Sanitizer	1g	10/unit
Certi-Tape	½" x 2-½ yd	2/unit
Eye Pads-4 & Certi-Tape-4	Oval/Strips	8/unit
Tourniquet & Scissors & Forceps	Assortment	3/unit
Gloves - Nitrile - Powder Free	Large	2/pair
Certi-Sporyn - Antibiotic Cream	1g	25/box
Certi-Burn Cream	1g	25/box
CPRotector® - Plastic Bag	5.5" sq	1
Cold Pack - Certi-Cool Junior	5" x 7"	1
Water Jel Burn Dressing	4" x 4"	1
Eye Wash	4 oz	1
Trauma Pad - Compress	5" x 9"	1
Sam· Splint	36"	1
First Aid Facts Guide	Book	1



K615-019

Class B First Aid Kits

- » Designed for High Risk work zones
- » Gasketed and weather resistant
- » Meets ANSI/ISEA Z308.1-2015 requirements

ITEM #	ORDER #	DESCRIPTION	UOM
K615-017	328000051	36PW First Aid Kit - Plastic Case	EA
K615-019	328000061	36M First Aid Kit - Metal Case	EA
KR615-017	328000321	36 First Aid Kit Refill	EA



First Aid - Class B



K616-025

FAC-3 - Class B - 3 Shelf Metal Cabinet

- » Designed for High Risk work zones
- » Meets ANSI/ISEA Z308.1-2015 requirements

ITEM #	ORDER #	DESCRIPTION	UOM
K615-025	328000081	FAC-3 Class B 3 Shelf Cabinet	EA
KR615-025	328000271	FAC-3 Class B 3 Shelf Cabinet Refill	EA

DESCRIPTION	Size	Pieces
Cold Pack - Certi-Cool Junior	5" x 7"	1
HSB - BloodBorne Pathogen	HSB	1
Eye Wash	4 oz	1
CPRotector® - Plastic Bag	5.5" sq	1
Certi-Tape - Spool - Tri Cut	2" x 5 yd	1
Certi-Rip - Elastic Cohesive Bandage - Tan	2" x 5 yd	1
Cotton Swabs	3"	100/vial
Water Jel Burn Dressing	4" x 4"	1
Antiseptic Towelettes	5" x 7"	25/box
Certi-Sporyn - Antibiotic Cream	1g	25/box
Certi-Burn Cream	1g	25/box
Hand Sanitizer	1g	10/unit
Eye Pads-4 & Certi-Tape-4	Oval/Strips	8/unit
Insect Sting Wipe-Ups	1" x 2"	10/unit
Tourniquet & Scissors & Forceps	Assortment	3/unit
Gloves - Nitrile - Powder Free	Large	2/pair
Certi-Gauze Pads	3" x 3"	25/box
Certi-Strips - Plastic	1" x 3"	50/box
Certi-Strips - Plastic	2" x 3"	25/box
Certi-Strips - Woven	Knuckle	25/box
Certi-Strips - Woven	Fingertip	25/box
Certi-Stopper - XL-TD	4" x 60"	1
Sam Splint	36"	1
Trauma Pad - Compress	5" x 9"	1
Certi-Non-Stick Pads	2" x 3"	4/unit
Certi-Gauze Rolls	2" x 6 yd	2/unit
Certi-Gauze Roll	4" x 6 yd	1/unit
Triangular Bandage - w/Pins	40" x 40" x 56"	3/unit
WoundSeal	Tube	2
First Aid Facts Guide	Book	1



K615-034

FAC-3 - Class B - Blue Metal Detectable - 3 Shelf Metal Cabinet

- » Designed for High Risk work zones
- » Meets ANSI/ISEA Z308.1-2015 requirements

ITEM #	ORDER #	DESCRIPTION	UOM
K615-034	328000161	FAC-3 Class B 3 Shelf Cabinet - Metal Det.	EA
KR615-034	328000241	FAC-3 Class B 3 Shelf Cabinet Refill	EA

DESCRIPTION	Size	Pieces
Cold Pack - Certi-Cool Junior	5" x 7"	1
Water Jel Burn Dressing	4" x 4"	1
HSB - BloodBorne Pathogen	HSB	1
Sam® Splint	36"	1
Certi-Rip - Elastic Cohesive Bandage - Tan	2" x 5 yd	1
CPRotector® - Plastic Bag	5.5" sq	1
Cotton Swabs	3"	100/vial
Certi-Tape - Spool - Tri Cut	2" x 5 yd	1
Certi-Strips - Woven - BMD	1" x 3"	50/box
Certi-Strips - Woven - BMD	2" x 3"	6/unit
Certi-Strips - Woven - BMD	Fingertip	10/unit
Certi-Strips - Woven - BMD	Knuckle	8/unit
Certi-Non-Stick Pad	2" x 3"	4/unit
Certi-Gauze Rolls	2" x 6 yd	2/unit
Certi-Gauze Roll	4" x 6 yd	1/unit
Triangular Bandage - w /Pins	40" x 40" x 56"	3/unit
Eye Pads-4 & Certi-Tape-4	Oval/Strips	8/unit
Tourniquet & Scissors & Forceps	Assortment	3/unit
Certi-Gauze Pads	3" x 3"	25/box
Certi-Stopper - XL-TD	4" x 60"	1
Trauma Pad - Compress	5" x 9"	1
Hand Sanitizer	1g	10/unit
Gloves - Nitrile - Powder Free	Large	2/pair
Certi-Sporyn - Antibiotic Cream	1g	25/box
Certi-Burn Cream	1g	25/box
Antiseptic Towelettes	5" x 7"	25/box
Eye Wash	4 oz	1
WoundSeal	Tube	2
First Aid Facts Guide	Book	1



K616-002

OTC - Class B Field Trauma - Bag

- » Portable trauma bag for High Risk work zones
- » Meets ANSI/ISEA Z308.1-2015 requirements

ITEM #	ORDER #	DESCRIPTION	UOM
K616-002	328000151	Trauma Bag	EA
KR616-002	328000251	Trauma Bag Refill	EA

DESCRIPTION	Size	Pieces
Certi-Strips - Plastic	1" x 3"	50/box
Certi-Strips - Plastic	2" x 3"	25/box
Certi-Strips - Woven	Knuckle	25/box
Certi-Strips - Woven	Fingertip	25/box
Certi-Gauze Pads	3" x 3"	25/box
Antiseptic Towelettes	5" x 7"	25/box
Water Jel Cool Jel	1/8 oz	6/unit
Water Jel Burn Dressing	4" x 16"	1
Water Jel Burn Dressing	4" x 4"	1
Cold Pack - Certi-Cool Junior	5" x 7"	1
Certi-Tape - Spool - Tri Cut	2" x 5 yd	1
Certi-Rip - Elastic Cohesive Bandage - Tan	2" x 5 yd	1
Certi-Sporyn - Antibiotic Cream	1g	25/box
Certi-Burn Cream	1g	25/box
Certi-Non-Stick Pad	2" x 3"	4/unit
Certi-Gauze Rolls	2" x 6 yd	2/unit
Certi-Gauze Roll	4" x 6 yd	1/unit
Triangular Bandage - w/Pins	40" x 40" x 56"	3/unit
Eye Pads-4 & Certi-Tape-4	Oval/Strips	8/unit
Hand Sanitizer	1g	10/unit
Tourniquet - Latex Free	1" x 17"	1
Gloves - Nitrile	Large	2/pair
First Aid Facts Guide	Book	1
Trauma Pad - Compress	5" x 9"	1
Lip Balm Stick	.15 oz	1
Insect Sting Wipe-Ups	1" x 2"	1
IvyX Pre-Contact Towelettes	5" x 8"	1
IvyX Post-Contact Cleanser Towelettes	8" x 5"	1
SunX 30+ Lotion - Pouch	1/4 oz	1
IvyX Anti-Itch Gel	1g	1
Eye Wash	4 oz	1
Cotton Swabs	3"	100/vial
Certi-Stopper - XL-TD	4" x 60"	1
Bite Stick - Hard Plastic	3.5"	1
Tweezers w/Magnifier	3.5"	1
Scissors All-Purpose - EMT Style	6"	1
Sam® Splint	36"	1
ZLB - Supplemental First Aid	ZLB	13
HSB - BloodBorne Pathogen	HSB	1
CPRotector® - Plastic Bag	5.5" sq	1



First Aid - Class B



K616-029

FAC-3 - Class B - 4 Shelf Metal Cabinet

- » Designed for High Risk work zones
- » Meets ANSI/ISEA Z308.1-2015 requirements

ITEM #	ORDER #	DESCRIPTION	UOM
K615-029	328000091	FAC-4 Class B 4 Shelf Cabinet	EA
KR615-029	328000291	FAC-4 Class B 4 Shelf Cabinet Refill	EA

DESCRIPTION	Size	Pieces
Certi-Stopper - XL-TD	4" x 60"	1
Trauma Pad - Compress	5" x 9"	1
Certi-Gauze Rolls	2" x 6 yd	2/unit
Certi-Gauze Roll	4" x 6 yd	1/unit
Triangular Bandage - w/Pins	40" x 40" x 56"	3/unit
Hand Sanitizer	1g	10/unit
Eye Pads-4 & Certi-Tape-4	Oval/Strips	8/unit
Insect Sting Wipe-Ups	1" x 2"	10/unit
Tourniquet & Scissors & Forceps	Assortment	3/unit
Gloves - Nitrile - Powder Free	Large	2/pair
Certi-Strips - Plastic	1" x 3"	100/box
Certi-Strips - Plastic	¾" x 3"	50/box
Certi-Strips - Plastic	2" x 3"	25/box
Certi-Strips - Woven	1" x 3"	50/box
Certi-Strips - Woven	Knuckle	50/box
Certi-Strips - Woven	Fingertip	50/box
Certi-Non-Stick Pads	2" x 3"	25/box
Certi-Gauze Pads	3" x 3"	25/box
Certi-Sporyn - Antibiotic Cream	1g	25/box
Certi-Burn Cream	1g	25/box
Antiseptic Towelettes	5" x 7"	25/box
Water Jel Burn Dressing	4" x 4"	1
Cold Pack - Certi-Cool Junior	5" x 7"	1
Eye Wash	4 oz	1
Cotton Swabs	3"	100/vial
Certi-Tape	1" x 5 yd	1
Certi-Tape - Spool - Tri Cut	2" x 5 yd	1
Certi-Rip - Elastic Cohesive Bandage - Tan	2" x 5 yd	1
CPRotector® - Plastic Bag	5.5" sq	1
HSB - BloodBorne Pathogen	HSB	1
Sam® Splint	36"	1
WoundSeal	Tube	2
First Aid Facts Guide	Book	1



First Aid - Classic Kits



Classic First Aid Kit

- » White plastic case
- » General purpose first aid kit
- » Includes multiple sizes Certi-Strips, Certi-Gauze, antibiotic cream, Certi-Burn cream, gloves, tape, absorbant compress, and other general use first aid items

K610-027



K610-033

ITEM #	ORDER #	DESCRIPTION	UOM
K610-027	328000101	10PW - 10 Person First Aid Kit	EA
K610-029	328000111	16PW - 25 Person First Aid Kit w/ Eyewash	EA
K610-033	328000121	24PW - 50 Person First Aid Kit	EA

First Aid - Bloodborne Pathogen



Bloodborne Pathogen Kits

- » Provides appropriate personal protective equipment to employees that could be exposed to blood or other potentially infectious materials
- » Includes gloves, gowns, face shields, masks, eye protection, biohazard bag, and bag with scoop and handle scraper

FK200-970



FK200-931

ITEM #	ORDER #	DESCRIPTION	UOM
FK200-970	328000211	10PW - Bloodborne Pathogen Economy - Plastic white case	EA
FK200-969	328000181	HSB - Bloodborne Pathogen Economy - Heat Sealed Bag	EA
FK200-931	328000201	10M - Bloodborne Pathogen Deluxe - Metal white case	EA
FKR200-906	328000301	Bloodborne Pathogen Deluxe Refill	EA

First Aid - Heat Stress



Heat Stress Relief Kit

- » Plastic red case

K613-040



ITEM #	ORDER #	DESCRIPTION	UOM
K613-040	328000361	Heat Stress Relief Kit	EA

DESCRIPTION	Size	Pieces
Cold Pack - Certi-Cool Junior	5" x 7"	1
Thermometer - Forehead - Reusable	¾" x 3.5"	1
Certi-Tape	1" x 5 yd	1
Rescue Blanket - Silver in Plastic Bag	52" x 84"	1
IXL Stick - Blue/Rasp - 0 Sodium	16.9 fl oz	1
First Aid Facts Guide	Card	1



First Aid

FIRST AID



019742-0029L



019743-0030L



019744-0031L

Construction Bulk First Aid Kits

- » Meets need for minor injuries in construction environment
- » Plastic
- » OSHA 1926.50

ITEM #	ORDER #	DESCRIPTION	SIZE	UOM
019742-0029L	347627481	10 Person	8" x 5.125" x 2.75"	EA
019743-0030L	347627491	25 Person	10.25" x 7" x 3"	EA
019744-0031L	347627501	50 Person	10" x 10" x 3"	EA

DESCRIPTION	019742-0029L 10 Person	019743-0030L 25 Person	019744-0031L 50 Person
Adhesive Bandage, 1" x 3", Plastic	16	32	100
Adhesive Tape, 0.5" x 2.5 yds	1	1	2
Ammonia Inhalants	—	—	10
Antibiotic Ointment Pouch	6	6	12
Antiseptic Wipes, BZK	6	6	12
Buffered Eyewash, 1 oz	—	—	1
Emergency Pressure Bandage	—	—	1
Eye Pad, Sterile	2	2	4
First Aid/Burn Cream with Aloe	6	6	12
Forceps, Pointed, Plastic	1	1	1
Gauze Pads, Sterile, 3" x 3"	4	4	10
Instant Cold Pak	1	1	2
Knuckle Bandage, Cloth	—	—	8
Medical Gloves, Synthetic (Pair)	2	2	4
Non-Aspirin Pain Reliever, 2/Pouch	3	3	6
Roller Bandage, 3" x 6 yds, Non-Sterile	1	1	2
Scissors, Angled, Red Handle	1	1	1
Sting Relief Wipes	6	6	12
Trauma Pad, 5" x 9", Sterile	1	1	2
Triangular Bandage, Non-Sterile	1	1	1



Blood Borne Pathogens Kit

- » Supplies to clean a spill containing bloodborne pathogens
- » PPE necessary to protect employees in accordance with OSHA 1910.130
- » Plastic kit
- » 8" x 5.125" x 2.75"

ITEM #	ORDER #	DESCRIPTION	UOM
019748-0033L	34762752	10 Unit Size	EA



019748-0033L

DESCRIPTION	019748-0033L
Absorbent Towel	1
Antiseptic Wipes, BZK	1
Biohazard Bag, 24" x 24"	1
Germicidal Surface Wipe	1
Medical Gloves (Pair)	1
Plastic Shovel	1
Twist Tie	1
Vital 1® Absorbent, 2 oz	1



First Aid

Honeywell

NORTH

Bulk First Aid Kits

» Contain economic bulk supplies easily accessed when needed

» Ideal for manufacturing settings



FAK25PL-CLSA



FAK50STL-CLSA



FAK100CAB-CLSB

ITEM #	ORDER #	DESCRIPTION	SIZE	UOM
019700-0001L	347627131	10 Person, Plastic, ANSI 2009	5"H x 8"W x 2.27"D	EA
019701-0001L	347627141	10 Person, Metal, ANSI 2009	5"H x 8"W x 2.63"D	EA
FAK25PL-CLSA	314000111	25-Person, Plastic, ANSI 2015. Class A	7"H x 10.25"W x 3"D	EA
FAK25STL-CLSA	314000091	25-Person, Steel, ANSI 2015. Class A	7"H x 10.25"W x 3"D	EA
FAK50PL-CLSA	341574841	50-Person, Plastic, ANSI 2015. Class A	11"H x 15.75"W x 3"D	EA
FAK50STL-CLSA	314000161	50-Person, Steel, ANSI 2015. Class A	11"H x 15.75"W x 3"D	EA
019709-0005L	347627221	10 Person, Unitized, Metal, ANSI 2009	5"H x 8"W x 2.625"D	EA
FAK100CAB-CLSB	314000171	100 Person, Station, ANSI 2015. Class B	10.5"W x 15"H x 4.75"D	EA

	DESCRIPTION	019700-0001L	FAK25PL-CLSA	FAK50PL-CLS	019709-0005L	FAK100CAB-CLSB
		019701-0001L	FAK25STL-CLSA	FAK50STL-CL	10 Users	100 Users
BANDAGES	Adhesive Bandage, 2" x 4"	2	1	2	—	6
	Adhesive Bandage, 1" x 3" Plastic	16	32	100	16	100
	Fingertip Bandage	1	3	4	—	40
	Knuckle Bandage	—	2	3	—	40
	Triangular Bandage, 40" x 40" x 56"	1	1	1	—	2
	Roller Bandage, 2"	1	2	3	—	4
	Roller Bandage, 3"	1	1	2	—	—
	Roller Bandage, 4"	—	—	—	—	4
	Elastic Bandage 2" x 4.5 yds.	—	—	1	—	—
	Elastic Bandage 3" x 4.5 yds.	—	—	—	—	1
PADS, TAPES, ANTIBIOTICS	Neomycin Antibiotic	6	10	10	6	30
	Blood Stopper Trauma Pad	—	—	—	—	4
	Trauma Pad, 5" x 9"	1	2	2	—	—
	Gauze Pad, 2" x 2"	4	—	—	—	10
	Gauze Pad, 3" x 3"	1	4	10	1	25
	Adhesive Tape 1" x 5 yds.	—	—	—	—	2
	Adhesive Tape 0.5" x 5 yds.	2	2	2	2	—
BURN CARE	Non Adherent Pads 2" x 3"	—	—	—	—	10
	Burn Relief Pump 2 oz	—	—	—	—	1
	Burn Relief Foil Pack	6	10	10	6	—
EYE CARE	Burn Dressing 4" x 4"	—	1	1	—	2
	Eye Pads w/Adhesive Strips	—	4	4	—	8
	Eyewash, 1 oz	—	1	1	—	—
MISCELLANEOUS	Eyewash, 4 oz	—	—	—	—	1
	Antiseptic Wipe	10	10	10	—	—
	Antiseptic Pump 2 oz	—	—	—	—	1
	Alcohol Prep Pads	—	—	—	—	10
	Hand Sanitizer, .9 g	—	10	10	—	10
	Sting Relief Wipe	6	6	6	—	—
	Cold Pack 5" x 6"	1	1	1	1	2
	Scissors	1	1	1	1	1
	Tweezers	1	1	1	—	1
	Exam Gloves, Pair	1	2	4	1	4
	Non-Aspirin Pain Reliever, 2/Pouch	3	3	3	—	50
	CPR Filtershield	—	1	1	—	1
	First Aid Guide	1	1	1	1	1
Tourniquet w/Tag and Pencil	—	—	—	—	1	
Wire Splint	—	—	—	—	1	



First Aid



019730-0017L

Honeywell NORTH

Specialty First Aid Kit

- » Steel
- » Designed for construction environment

ITEM #	ORDER #	DESCRIPTION	SIZE	UOM
019730-0017L	347627361	16 Person	9.5" x 6.625" x 2.625"	EA

DESCRIPTION	019730-0017L
Plastic Adhesive Bandage, 1" x 3"	32
Adhesive Tape, 0.5" x 2.5 yds	2
Compress Bandage, 4" Offset	1
Triangular Bandage, Non-Sterile	1
Gauze Pads, 3" x 3", Sterile	4
First Aid/Burn Cream w/Aloe	6
Eye-Lert® Eyewash, 1 oz	1
Eye Dressing w/(4) Adhesive Strips	4
Forceps, Pointed, Plastic	1
Instant Cold Pak	1
Medical Gloves, Synthetic	2 pr
PVP Iodine Wipes	10
Ammonia Inhalant	10
Alcohol Prep Pads	10

Honeywell NORTH

222® Barrier Cream with Silicone

- » For wet or dry work environments
- » Barrier against many sticky, staining, irritating industrial substances

ITEM #	ORDER #	DESCRIPTION	UOM
272204	347622041	4 oz	EA



272204



122004XA

Honeywell NORTH

BugX® 30 Insect Repellent Towelettes In Dispenser

- » 8" x 5" size for full coverage
- » DEET 30%
- » Repels mosquitoes, ticks, fleas, mites, black flies, sand flies and deerflies

ITEM #	ORDER #	DESCRIPTION	UOM
122004XA	347629961	50 per Dispenser	BX



Eyewash



Portable Emergency Eyewash Station

- » No plumbing required, mounting bracket included
- » One-hand operation
- » Holds 9 Gal of water
- » 15 minute flow time
- » Locking cap (lock not included)
- » Meets ANSI Z358.1

ITEM #	ORDER #	DESCRIPTION	UOM
5134-00	G7350006	Eyewash Station	EA



5134-00



32-000454-0000

Honeywell

Eyesaline® Personal Eyewash Bottles

- » Portable and ready to use
- » Sterile, buffered, saline is superior to tap water for emergency eye care
- » User controls delivery of drops or an irrigating stream of solution
- » Three-year shelf life from manufacture date
- » English/Spanish

ITEM #	ORDER #	DESCRIPTION	UOM
32-000451-0000	34150105	1 oz. Bottles	4/Cs
32-000454-0000	341501071	16 oz. Bottles	EA
32-000455-0000	341501081	32 oz. Bottles	EA



32-000461-0000

Honeywell

Eyesaline® Wall Eyewash Station

- » No plumbing required, mounting bracket included
- » Highly visible and available for emergency flushing
- » Designed for easy "snap-out" access to eyewash
- » Features bilingual (English/Spanish) instructions
- » Meets ANSI Z358.1

ITEM #	ORDER #	DESCRIPTION	UOM
--------	---------	-------------	-----

Single Wall Station

32-000460-0000	341501091	16 oz. Bottle	EA
32-000461-0000	341501101	32 oz. Bottle	EA

Double Wall Station

32-000465-0000	34156501	16 oz. Bottles	CS
32-000462-0000	341501111	32 oz. Bottles	EA



32-000462-0000

Honeywell

Fendall Pure Flow 1000® Eyewash Station

- » No plumbing required
- » Delivers 15 minutes of flushing
- » Factory sealed cartridges for easy of use
- » Integral fluid reservoir captures waste fluid
- » Easy-view window
- » Meets ANSI Z358.1

ITEM #	ORDER #	DESCRIPTION	UOM
32-001000-0000	341554681	Eyewash Station, English	EA
32-001050-0000	341500791	Refill Cartridges, Trilingual	PR



32-001050-0000



32-001000-0000



Eyewash

Honeywell

Fendall Porta Stream® I Eyewash Station

- » Delivers 6 minutes of uninterrupted, hands-free flushing
- » Gravity-fed flow begins immediately when the nozzle pull strap is removed
- » No plumbing required
- » Portable
- » Includes 70 oz. saline concentrate
- » Large fill hole



32-000100-0000

ITEM #	ORDER #	DESCRIPTION	UOM
32-000100-0000	341500761	Eyewash	EA



32-000200-0000

Honeywell

Fendall Porta Stream® II Eyewash Station

- » Offers versatile portability and 15 minutes of uninterrupted flushing
- » Gravity-fed flow begins immediately when the nozzle pull strap is removed
- » No plumbing required
- » Large fill hole w/lockable fill cap
- » Includes 180 oz. saline concentrate
- » Meets ANSI Z358.1

ITEM #	ORDER #	DESCRIPTION	UOM
32-000200-0000	341500881	Eyewash Station w/ Saline Concentrate	EA

Honeywell

Eyesaline® Replacement Saline Solutions

- » For use to refill Porta Stream eyewash stations
- » Concentrate (10:1) or premixed (ready to use)
- » 30-month self life, 6-months once opened from manufacture date



32-000502-0000

ITEM #	ORDER #	DESCRIPTION	UOM
32-000502-0000	341501141	1 Gal Premix - Ready to Use	EA
32-000513-0000	341501171	180 oz. Concentrate	EA
32-000509-0000	341501151	70 oz. Concentrate	EA



Eyewash

Guardian

AquaGuard Gravity-Flow Portable Eyewash, 16 Gal

- » Self-contained 16 Gal gravity-flow eyewash unit is ideal for use in low traffic areas, and where a continuous supply of potable water is unavailable for plumbed units
- » Rugged plastic tank
- » Built-in carrying handle
- » Furnished with bracket for optional wall mounting
- » Meets ANSI Z358.1-2014

ITEM #	ORDER #	DESCRIPTION	UOM
G1540	B73101151	Eyewash Station	EA
G1540HTR	B7311546	Eyewash Station with Heated Orange Insulation Jacket	EA



G1540

Guardian

15 Gal Portable Eyewash/Drench Hose Units

- » Self-contained units for use in low traffic areas and where a continuous supply of potable water is unavailable for plumbed units
- » Provides 10 usable Gal (37.9 L) for effective rinsing of eyes, face or body for 15 min
- » Pressure regulator controls eyewash flow to 0.65 GPM for 15 min
- » Two eyewash spray heads have flip top dust covers, flow control and filter
- » Hand held drench hose unit has spray head, squeeze handle and 6' hose
- » Unit has built-in carrying handles
- » Bacteriostatic additive supplied with unit
- » Meets ANSI Z358.1-2014 for eyewashes

ITEM #	ORDER #	DESCRIPTION	UOM
G1562	B7311562	Eyewash/Drench Hose Unit	EA
G1562HTR	B7311547	Eyewash/Drench Hose Unit w/Heated Jacket	EA
G1562DLY	B7310358	Stainless Steel Dolly w/Lockable Casters	EA



G1562HTR



G1562

Guardian

EyeSafe™ and EyeSafe-X™ Faucet-Mounted Eyewash Stations

- » Converts any faucet into an emergency eyewash station
- » Won't interfere with normal faucet operation
- » Angle of outlet heads are adjustable to permit full coverage and avoid splashing
- » Dust covers protect outlet heads
- » Pull knob activates eyewash
- » Inlet body has 0.859375"-27 female thread and comes with three adaptors to install on most faucets
- » Removable aerator at outlet is furnished
- » Completely assembled



G1101



G1100

ITEM #	ORDER #	DESCRIPTION	UOM
G1100	B73101021	EyeSafe Faucet-Mounted Eyewash Station	EA
G1101	B73101031	Eye-Safe-X Faucet-Mounted Eyewash Station, Gooseneck Version	EA



Eyewash



Wall Mounted Eyewash Stations

- » Two GS-Plus™ spray heads with flow control and filter
- » Aluminum flag run/handle
- » Valve: 0.5" IPS brass stay-open ball valve with PTFE seals
- » Supply inlet: 0.5" NPT female
- » Waste outlet: 1.25" NPT female
- » Heavy duty cast aluminum wall bracket with powder coated finish
- » Fully assembled and tested
- » ANSI-compliant sign included



G1814



G1814BC



ITEM #	ORDER #	DESCRIPTION	UOM
G1814	B73102031	Eyewash Station w/ Stainless Steel Bowl	EA
G1814P	B73102041	Eyewash Station w/ ABS Plastic Bowl	EA
G1814BC	B73111141	Eyewash Station w/ Stainless Steel Bowl and Cover	EA



Wall Mounted Eye/Face Wash Stations

- » Two FS-Plus™ spray heads with flow control and filter
- » Aluminum flag run/handle
- » Valve: 0.5" IPS brass stay-open ball valve with PTFE seals
- » Supply inlet: 0.5" NPT female
- » Waste outlet: 1.25" NPT female
- » Heavy duty cast aluminum wall bracket with powder coated finish
- » Fully assembled and tested
- » ANSI-compliant sign included



G1750



G1750BC



ITEM #	ORDER #	DESCRIPTION	UOM
G1750	B73101661	Eye/Face Wash Station w/ Stainless Steel Bowl	EA
G1750P	B73101671	Eye/Face Wash Station w/ ABS Plastic Bowl	EA
G1750BC	B7310332	Eye/Face Wash Station w/ Stainless Steel Bowl and Cover	EA



G1750P



G1825

G1825BC



Free Standing Pedestal-Mounted Eyewash Stations

- » Two GS-Plus™ spray heads with flow control and filter
- » Aluminum flag run/handle
- » Pipe/fittings: Schedule 40 galvanized steel. Furnished with orange polyethylene pipe covers
- » Supply inlet: 0.5" NPT female
- » Waste outlet: 1.25" NPT female
- » ANSI-compliant sign included

ITEM #	ORDER #	DESCRIPTION	UOM
G1825	B73102101	Eyewash Station w/ Stainless Steel Bowl	EA
G1825P	B73102121	Eyewash Station w/ ABS Plastic Bowl	EA
G1825BC	B7311825	Eyewash Station w/ Stainless Steel Bowl and Cover	EA



Eyewash

Guardian

Deck/Sink Mounted Eyewash Station

- » Spray heads swivel 90° from storage to operational position
- » Two GS-Plus™ spray heads with “flip top” dust covers, flow control and filter
- » Unit can be installed on deck next to sink on right side (G1806) or left side (G1806LH)
- » Aluminum flag run/handle
- » Valve: 0.5" IPS brass stay-open ball valve with PTFE seals
- » Supply inlet: 0.5" NPT male
- » Fully assembled and tested
- » ANSI-compliant sign included



G1806

ITEM #	ORDER #	DESCRIPTION	UOM
G1806	B73101981	Eyewash Station 90° Swivel, Right Hand Mount	EA
G1806LH	B73101991	Eyewash Station 90° Swivel, Left Hand Mount	EA

Guardian

Eyewash/Drench Hose Stations

- » Dual purpose eyewash/drench station for wall mounting (G5026) or deck mounting (G5022)
- » Meets ANSI Z358.1-2014 as both an eyewash and drench hose
- » Fixed position use or hand held hose for use to rinse any part of the body
- » Two GS-Plus™ spray heads with “flip top” dust covers, flow control and filter
- » 8' reinforced PVC hose
- » Fully assembled and tested
- » ANSI-compliant sign included

ITEM #	ORDER #	DESCRIPTION	UOM
G5026	B73102851	Deck Mounted	EA
G5022	B73102811	Wall Mounted	EA



G5026

G5022

Showers & Eyewash

Guardian

Emergency Shower Stations

- » 10" orange ABS plastic shower head with stainless steel actuating arm and 29" pull rod
- » Vertically mounted (G1635) or horizontally mounted (G1643)
- » 1" IPS brass stay-open ball valve with PTFE seals
- » Supply inlet: 1" NPT female
- » ANSI-compliant sign included

ITEM #	ORDER #	DESCRIPTION	UOM
G1635	B73101271	Vertically Mounted	EA
G1643	B73101311	Horizontally Mounted	EA



G1635

G1643



Showers & Eyewash



Shower Safety Stations with Eyewash

- » Combination overhead shower and separate eyewash station
- » 10" orange ABS plastic shower head with stainless steel actuating arm and 29" pull rod
- » Shower Valve: 1" IPS brass stay-open ball valve with PTFE seals
- » Two GS-Plus™ spray heads with flow control and filter for eyewash station
- » Eyewash valve: 0.5" IPS brass stay-open ball valve with PTFE seals
- » Pipe/fittings: Schedule 40 galvanized steel. Furnished with orange polyethylene pipe covers
- » Supply inlet: 1.25" NPT female top or side
- » ANSI-compliant sign included

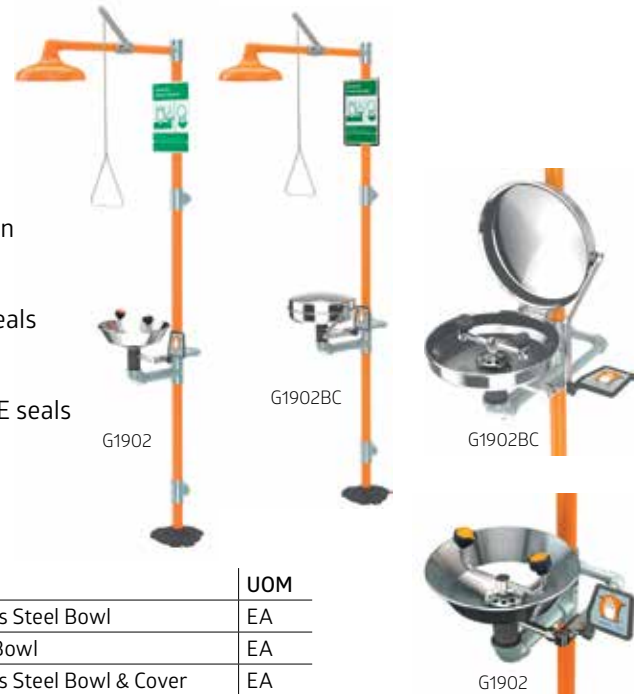

ITEM #	ORDER #	DESCRIPTION	UOM
G1902	B7311903	Shower Safety Station & Eyewash w/ Stainless Steel Bowl	EA
G1902P	B7311902	Shower Safety Station & Eyewash w/ Plastic Bowl	EA
G1902BC	B73103251	Shower Safety Station & Eyewash w/ Stainless Steel Bowl & Cover	EA



Heated Shower Safety Station with Eyewash

- » Heated combination overhead shower and separate eyewash station
- » Electric heat-traced station prevents freezing even in extreme conditions
- » Unit is fully wired at factory. Requires 120 VAC single phase power supply
- » Intended for cold weather use down to -40°F
- » 10" orange ABS plastic shower head with stainless steel actuating arm and 29" pull rod
- » Shower valve: 1" IPS brass stay-open ball valve with PTFE seals
- » Freeze-resistant spray head assembly with float-off dust covers and internal flow control
- » Eyewash valve: 0.5" IPS brass three-way self-draining stay-open ball valve with PTFE seals
- » Pipe/fittings: Schedule 40 galvanized steel. Furnished with orange polyethylene pipe covers
- » Supply inlet: 1.25" NPT female top
- » ANSI-compliant sign included

ITEM #	ORDER #	DESCRIPTION	UOM
GFR3100	B7313100	Heated Overhead Shower with Separate Eyewash Station	EA



Lockout/Tagout



50943

Brady® All Purpose Cable Lockout Device with 8" Cable

- » Compact, lightweight body is made of rugged impact modified glass filled nylon for superior chemical, corrosion and temperature resistance properties
- » Includes 1/8" diameter cable
- » Built-in cable loop keeps cable neatly coiled when stored and prevents it from dangling loose when device is being used

ITEM #	ORDER #	DESCRIPTION	UOM
50943	J05200411	8" Sheathed Metal Cable	1/EA
50941	J05200421	8" Non-conductive Nylon Cable	1/EA



65396

65321



Brady® Clamp-On w/Cleat Breaker Lockout Device

- » Extremely versatile - works on a wide range of single-pole and internal-trip multi-pole breakers
- » Easy to install using the proprietary thumbwheel design - no screwdrivers needed!
- » Isolates and secures circuit breaker switches to protect employees against electrical accidents during equipment maintenance

ITEM #	ORDER #	DESCRIPTION	UOM
65396	J05200441	120/277V	1/EA
65397	J05200451	480/600V	1/EA
65965	J05200975	120/277V	6/PK
65966	J05200985	480/600V	6/PK
73744	J05200591	277V	1/EA
65321	J05201075	480/600V, Oversized frame lockout fits breaker switches up to 2-1/4 in. wide and 7/8 in. thick	1/EA



65674



Brady® Electrical Plug Lockout Device

Electrical Plug Lockout Device

- » Prevents electrical plugs from being inserted into a wall outlet
- » Accommodates a large variety of plug shapes and sizes
- » Constructed of rugged polypropylene

3-In-1 Plug Lockout Device

- » Accommodates high and low-voltage plugs up to 3 in. in diameter and 5-1/2 in. in length
- » Two rotating top lids that can be used individually or together to fit small, medium & large-diameter cords up to 1-1/4 in.
- » Made of bright yellow thermoplastic material

ITEM #	ORDER #	DESCRIPTION	UOM
65674	J05200611	110 V, Red	1/EA
65675	J05200621	220/550 V, Red	1/EA
PL023	J05200661	High & Low Voltage, Yellow	1/EA



PL023



65375



Steel Group Hasps

- » Hasps are constructed of vinyl-coated high tensile steel with rust-resistant plating
- » Hasps allow multiple padlocks to secure a single lockout device

ITEM #	ORDER #	DESCRIPTION	UOM
65375	J05201135	1" diameter jaws	12/PK
65376	J05201145	1.5" diameter jaws	12/PK





Lockout/Tagout

LOCKOUT/TAGOUT



Adjustable Gate Valve Lockout Device

- » Adjusts to fit 1 in. to 6 1/2 in. diameter valve handles, replacing three conventional gate valve lockouts
- » Durable polypropylene which is resistant to extreme temperatures ranging from -13 to 194°F (-25 to 90°C)
- » Cover the valve handle with the gate valve lockout device and apply a personal padlock and lockout tag to ensure employee safety



64057

ITEM #	ORDER #	DESCRIPTION	UOM
64057	J05200471	Adjusts to fit 1 in. to 6 1/2 in. diameter valve handles	1/EA



65560



Brady® Gate Valve Lockout Device

- » Made of extremely rugged injection-molded polypropylene for superior impact and chemical resistance
- » Supplied with English, Spanish and French danger labels
- » Cover the valve handle with the gate valve lockout device and apply a personal padlock and lockout tag to ensure employee safety
- » Accepts padlock shackles up to 3/8" in diameter

ITEM #	ORDER #	DESCRIPTION	UOM
65560	J05200481	Gate valve for 1 - 2.5 in. diameter	1/EA
65561	J05200501	Gate valve for 2.5 - 5 in. diameter	1/EA



Lockout Tags

- » Excellent write-on surface is ideal for adding on-the-spot customized notes and other information
- » Paper cardstock tags are recommended for indoor use only
- » Not recommended for chemical exposure



65454



ITEM #	ORDER #	DESCRIPTION	Material	UOM
65501	J05201015	Self-Laminating DANGER: DO NOT OPERATE	Polyester	10/PK
65502	J05201025	Overlaminated DANGER: DO NOT OPERATE	Polyester	25/PK
65520	J05201035	Overlaminated DANGER: DO NOT OPERATE (w/ red stripes)	Polyester	25/PK
66050	J05201045	Self-Laminating DANGER: DO NOT OPERATE	Polyester	25/PK
66064	J05201055	Self-Laminating DANGER: DO NOT OPERATE (w/ red stripes)	Polyester	25/PK
65454	J05201065	Not Laminated DANGER: LOCKED OUT DO NOT OPERATE	Paper	25/PK

Lockout/Tagout



Lockout Stations



51186



51181



3003Y

5-Lock Capacity Padlock Center

- » Holds up to 5 locks, plus lockout hasps and tags
- » Board measures 11-1/2 in. H x 15-1/2 in. W
- » Boards are made of 3/16" thick bright yellow acrylic with acrylic lock rails and clear polycarbonate tag pockets that accommodate tags up to 3" wide

Economy Lockout Center with Steel Padlocks, Hasps and Tags

- » Kit contains lockout devices for single- and multi-pole breakers and electrical plugs, as well as hasps, padlocks, tags and a training booklet
- » Comes in a convenient toolbox made of rugged polyethylene that measures 4.5 in. H x 12 in. W x 6.5 in. D

ITEM #	ORDER #	DESCRIPTION	UOM
51186	J05200751	5-Lock Capacity Padlock Center with 5 Steel Padlocks	1/EA
51181	J05200761	5-Lock Capacity Padlock Center with 5 Safety Padlocks	1/EA
3003Y	J05200781	Economy Lockout Center with Steel Padlocks, Hasps and Tags	1/EA

WARNING: Cancer and Reproductive Harm - www.P65Warnings.ca.gov



Group Lock Boxes

Brady® Metal Wall Lockout Box

- » Durable, powder-coated steel with key slot on top and includes clear Lexan window that slides out when locks are removed
- » Includes key pegs and ID labels to simplify key management, and predrilled holes and hardware for quick mounting



105714



50938

Wall-Mounted Miniature Group Lockout Box

- » Injection molded using Isoplast polymers for extra durability, has excellent chemical and heat resistance
- » Patented lock rails accommodate up to 8 padlocks and the slot in front allows keys to be inserted when box is locked

Brady® Portable Metal Group Lockout Box

- » Made of heavy-duty steel and powder coated for extra rust-resistance
- » Accommodates up to 12 padlocks on the lid and can also be used as a lock storage box for up to 40 padlocks
- » Each employee retains exclusive control, as required by OSHA, by placing his own lock on the lockout box containing the keys to the job locks



51171

ITEM #	ORDER #	DESCRIPTION	UOM
105714	J05200701	7 in H x 8 in W x 2.25 in D, Metal Wall Lockout Box	1/EA
50938	J05200681	6.2 in H x 4 in W x 5.5 in D, Wall-Mounted Miniature Lockout Box	1/EA
51171	J05200671	6 in H x 7.375 in W x 9.25 in D, Portable Metal Group Lockout Box	1/EA
65699	J05200691	6 in H x 9 in W x 3.5 in D, Portable Metal Group Lockout Box	1/EA



Lockout/Tagout



Lockout Toolbox Kits

Premium Lockout Toolbox Kit

- » Premium kit includes lockout devices for breakers, wall switches, electrical plugs and gate valves, plus a cable lockout, AC voltage sensor and more
- » Comes in a convenient toolbox made of rugged polyethylene that measures 4.5 in. H x 12 in. W x 6.5 in. D
- » Complies with OSHA's Lockout Standard



LKP

Economy Lockout Kit with Toolbox

- » Kit contains lockout devices for single- and multi-pole breakers and electrical plugs, as well as hasps, padlocks, tags and a training booklet
- » Comes in a convenient toolbox made of rugged polyethylene that measures 4.5 in. H x 12 in. W x 6.5 in. D



65289

Basic Electrical Lockout Toolbox Kit with 1 Steel Padlock

- » Lockout devices for electrical and mechanical risks
- » Basic lockout toolbox kit that includes your most commonly used electrical devices
- » Includes lockout devices for gate valves, ball valves, electrical plugs, breakers and wall switches, as well as a hasp, tags and padlocks

ITEM #	ORDER #	DESCRIPTION	UOM
LKP	J05200771	Premium Lockout Toolbox Kit	EA
LKX	J05201171	Economy Lockout Kit with Toolbox	EA
65289	J05201151	Basic Electrical Lockout Toolbox Kit with 1 Steel Padlock	EA

WARNING: Cancer and Reproductive Harm - www.P65Warnings.ca.gov



51339



Nylon Lockout Padlocks – Keyed Different

- » Feature lightweight, nonconductive fiberglass-reinforced nylon bodies, hardened steel shackles and tamper-resistant 6-pin cylinders
- » Comply with all OSHA requirements and offer superior temperature, chemical and corrosion resistance
- » Safer alternative to metal locks for lockout applications
- » Each padlock is keyed differently with keys precision-machined to exacting standards, so that the key for one lock will not open another in the set

ITEM #	ORDER #	DESCRIPTION	UOM
99552	J05200951	Keyed Different, Red	EA
51339	J05200965	Keyed Different, Red	6/PK

WARNING: Cancer and Reproductive Harm - www.P65Warnings.ca.gov



Nylon Lockout Padlocks - 3 in. Shackle Clearance – Keyed Different

- » Patent-pending linear lock design allows for more precise key cutting, giving you more unique key codes and smoother key operation
- » Find it fast – keys and lock bodies are color matched to help you quickly find the key for your lock
- » Get years of use with the low-friction locking mechanism and durable one-piece body design
- » Nylon padlocks with steel shackles are lightweight and durable making them ideal for general lockout applications



ITEM #	ORDER #	DESCRIPTION	UOM
NYL-RED-76ST-KD	J05200341	Red	EA
NYL-YLW-76ST-KD	J05200351	Yellow	EA
NYL-BLU-76ST-KD	J05200361	Blue	EA



Lockout/Tagout



SafeKey Lockout Padlocks – Keyed Alike

- » Fewer keys, less confusion – six padlocks are keyed alike so each lock in the group can be opened with the same key, reducing the number of keys you need to track
- » Ideal for employees who work on multiple machines or isolation points
- » Patent-pending linear lock design allows for more precise key cutting, giving you more unique key codes and smoother key operation
- » Find it fast – keys and lock bodies are color matched to help you quickly find the key for your lock
- » Get years of use with the low-friction locking mechanism and durable one-piece body design
- » Keep it together – padlock is key retaining so you can keep your key and padlock together when not in use
- » 1.5 in. vertical clearance



NYL-BLU-38ST-KA6PK

ITEM #	ORDER #	DESCRIPTION	UOM
Nylon Padlocks with Steel Shackles			
NYL-RED-38ST-KA6PK	J05200835	Keyed Alike, Red	6/PK
NYL-YLW-38ST-KA6PK	J05200845	Keyed Alike, Yellow	6/PK
NYL-GRN-38ST-KA6PK	J05200855	Keyed Alike, Green	6/PK
NYL-BLU-38ST-KA6PK	J05200865	Keyed Alike, Blue	6/PK
Nylon Padlocks with Plastic Shackles - Non-conductive and Non-sparking			
NYL-RED-38PL-KA6PK	J05200875	Keyed Alike, Red	6/PK
NYL-YLW-38PL-KA6PK	J05200885	Keyed Alike, Yellow	6/PK
NYL-GRN-38PL-KA6PK	J05200895	Keyed Alike, Green	6/PK
NYL-BLU-38PL-KA6PK	J05200905	Keyed Alike, Blue	6/PK



NYL-RED-38PL-KA6PK



SafeKey Lockout Padlocks – Keyed Different

- » SafeKey padlocks get up to 700% more key codes than traditional safety padlocks
- » Patent-pending linear lock design allows for more precise key cutting, giving you more unique key codes and smoother key operation
- » Keys and lock bodies are color matched to help you quickly find the key for your lock
- » Get years of use with the low-friction locking mechanism and durable one-piece body design
- » Padlock is key retaining to keep your key and padlock together when not in use
- » Single keyed different padlocks are ideal for starting, or expanding, your lockout program
- » 1.5 in. vertical clearance



NYL-YLW-38ST-KD

ITEM #	ORDER #	DESCRIPTION	UOM
Nylon Padlocks with Steel Shackles			
NYL-RED-38ST-KD	J05200251	Red	EA
NYL-YLW-38ST-KD	J05200261	Yellow	EA
NYL-GRN-38ST-KD	J05200271	Green	EA
NYL-BLU-38ST-KD	J05200281	Blue	EA
NYL-RED-38ST-KD6PK	J05200795	Red	6/PK
NYL-YLW-38ST-KD6PK	J05200805	Yellow	6/PK
NYL-GRN-38ST-KD6PK	J05200815	Green	6/PK
NYL-BLU-38ST-KD6PK	J05200825	Blue	6/PK

ITEM #	ORDER #	DESCRIPTION	UOM
Nylon Padlocks with Plastic Shackles - Non-conductive and Non-sparking			
NYL-RED-38PL-KD	J05200371	Red	EA
NYL-YLW-38PL-KD	J05200381	Yellow	EA
NYL-GRN-38PL-KD	J05200391	Green	EA
NYL-BLU-38PL-KD	J05200401	Blue	EA
NYL-RED-38PL-KD6PK	J05200915	Red	6/PK
NYL-YLW-38PL-KD6PK	J05200925	Yellow	6/PK
NYL-GRN-38PL-KD6PK	J05200935	Green	6/PK
NYL-BLU-38PL-KD6PK	J05200945	Blue	6/PK



Lockout/Tagout

LOCKOUT/TAGOUT



V-Safe® Wheel Valve Cover Lockouts

- » The V-Safe® wheel valve cover consists of two flattened half moons that completely cover the valve wheel
- » Made of strong polypropylene plastic
- » Fully Dielectric
- » Highly resistant to cracking and abrasion
- » Resistant to extreme temperature changes from - 50° to 360°F



VS02



ITEM #	ORDER #	DESCRIPTION	UOM
VS02	347620021	For Wheel Valves 1" - 2.5"	EA
VS04	347620041	For Wheel Valves 2.5" - 5"	EA
VS06	347626071	For Wheel Valves 5" - 6.5"	EA
VS09	347626111	For Wheel Valves 6.5" - 10"	EA
VS13Y	347626161	For Wheel Valves 10" - 13"	EA



B-Safe® Ball Valve Lockouts

- » Lockout and tagout
- » Dielectric
- » Resistant to most solvents
- » Made of polypropylene plastic



BS01R



BS04R

ITEM #	ORDER #	DESCRIPTION	UOM
BS01R	347600031	For Ball Valves "In Open Position" .375" – 1.25", .875"W Handle	EA
BS02R	347699021	For Ball Valves 1.5" - 2.5", .875"W Handle	EA
BS03R	347605991	For Ball Valves 2" - 8", 1.625"W Handle	EA
BS04R	347606051	Universal Butterfly Valve, 1.625"W Handle	EA



CBLOK06R

Multi-Purpose Cable Lockouts

- » Highly visible red nylon hasp holds up to 6 padlocks
- » PVC coated .1875" thick galvanized steel cable
- » Available in corrosion resistant cables, 6' or 10' lengths

ITEM #	ORDER #	DESCRIPTION	UOM
CBLOK06R	347607411	6' Long Cable	EA
CBLOK10R	347607421	10' Long Cable	EA

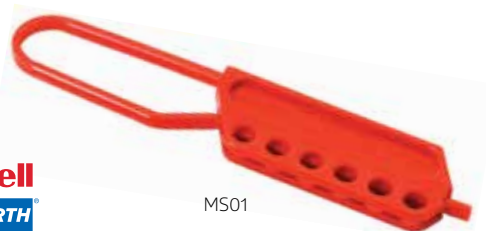

MS01

M-Safe® Lockout Hasp

- » Electrical safety lockout hasp
- » Bright red heavy-duty nylon hasp holds up to 6 padlocks
- » Fully Dielectric

ITEM #	ORDER #	DESCRIPTION	UOM
MS01	347619881	Heavy-Duty Nylon Lockout Hasp	EA



Lockout/Tagout



CB01R



CB02R



CB03R

C-Safe® Circuit Breaker Lockouts

- » Available in single or double pole circuit breaker configurations
- » Made of red Polyamide plastic
- » 6 per pack

ITEM #	ORDER #	DESCRIPTION	UOM
CB01R	347600075	Single Pole, Requires a Circuit Breaker with a Recessed Hole. Fits Breakers to .5625"W (14 mm) in Off Position, 6/Pk	PK
CB02R	347607455	Double pole, Requires Circuit Breakers Connected with a Cross Bar. Fits Breakers up to .625"W (16 mm) in Off Position, 6/Pk	PK
CB03R	347600135	Single Pole, Does Not Require a Switch with a Recessed Hole. Fits Breakers to .5625"W (14 mm), 6/Pk	PK



E-Safe® Plug Lockout Kits

- » Electrical plug lockout kits
- » Lock-a-Plug shell completely encloses the plug when closed
- » Fully Dielectric
- » Made of red polypropylene plastic

ITEM #	ORDER #	DESCRIPTION	UOM
LP110	347601101	For 110 V, Cord Dia to .5" (12 mm). Plug to 1.75" x 1.75" x 3.25" (44.5 x 44.5 x 82 mm)	EA
LP550	347605501	For 220/550 V, Cord Dia to 1" (25 mm). Plug to 3" x 3" x 6.75" (76 x 76 x 170 mm)	EA



LP110



LP550



Wipes & Cleaners



3841-08-CLMS



3841-16-ECO

PURELL™ Body Fluid Spill Kit

- » Provides a comprehensive solution to help reduce the risk of Norovirus outbreaks
- » Safely removes vomit, blood, feces & other body fluids
- » PURELL® Foodservice Surface Sanitizer is effective against Norovirus, E.Coli, Salmonella and more in just 30 seconds, and is proven effective on most hard and soft surfaces
- » Bilingual, step-by-step instructions for ease of use
- » OSHA and Food Code compliant
- » Approved for food contact surfaces (no rinse required)
- » Includes hairnet, sleeved gown, gloves, shoe covers, eye shield and mask to provide head-to-toe personal protection
- » 3-year shelf life

ITEM #	ORDER #	DESCRIPTION	UOM
3841-08-CLMS	354009401	Plastic clam shell kit with two single use refills	EA
3841-16-ECO	354009421	Sustainable* single use kit	EA
3841-16-RFL	354009411	Clam Shell Refill	EA



3342-03



4342-04

PURELL® Professional Surface Disinfectant

- » One-step disinfectant /cleaner with a fresh citrus scent
- » Kills Norovirus and MRSA in 30 seconds
- » Kills 99.9% of germs on surfaces, including the cold & flu virus
- » No rinse required on food contact surfaces
- » Proven effective across most hard and soft surfaces
- » Awarded the U.S. EPA Design for the Environment certification (DfE)
- » Sealed & capped bottles with triggers included

ITEM #	ORDER #	DESCRIPTION	UOM
3342-03	35400597	32 oz. RTU - bottles capped & sealed with triggers	3/CS
4342-04	35400585	1 Gallon RTU refills	4/CS



7265-D2



GOJO® MULTI GREEN® Hand Cleaner

- » Multi-purpose hand cleaner with natural pumice scrubbers
- » Gel-style hand cleaner clings to hands and spreads easy
- » Contains natural pumice scrubbers
- » USDA BioPreferred® Certified, readily biodegradable
- » Contains a natural citrus solvent
- » Meets California VOC requirement for consumer products
- » SANITARY SEALED™ refill helps prevent contamination
- » Effective on oil, grease, paint, tar, and asphalt

ITEM #	ORDER #	DESCRIPTION	UOM
7265-D2	35400968	Starter Kit: 1 Dispenser / 1 Refill	CS
7265-04	354000181	2000 mL Refill for Dispenser	EA



7278-08



0972-04

GOJO® SUPRO MAX™ Hand Cleaner

- » Fast and effective heavy-duty hand cleaner with gentle scrubbers
- » Unique blend of cleaners and skin conditioners help leave skin feeling healthy
- » Non-drying formula
- » Gentle on skin
- » Effective on oil, grease, paint, and adhesives

ITEM #	ORDER #	DESCRIPTION	UOM
0979-02	35400936	1 Gallon w/ Pump Dispenser	2/CS
0972-04	35400969	.5 Gallon w/ Pump Dispenser	4/CS
7278-08	35400108	10 fl oz Bottle	8/CS
2370-01	35407001	0.5 fl oz Packet	40/CS

Wipes & Cleaners



PURELL® Professional HEALTHY SOAP® Fresh Scent Foam

- » Mild foam hand soap with pleasant fragrance
- » Elegant design complements décor
- » AT-A-GLANCE™ refills provide the easiest way to see when refills need to be changed
- » SANITARY SEALED™ PET refill bottle with removable collar for easy recycling
- » LOCK OR NOT™ technology - can convert to a locking system

ITEM #	ORDER #	DESCRIPTION	UOM
5077-1G	35400799	Starter Kit: 1 Dispenser / 1 Refill	CS
5077-02	35400710	1200 mL Refill for Dispenser	2/CS



PURELL® Foodservice Advanced Hand Sanitizer Foam

- » Advanced foam hand sanitizer formulation designed for foodservice environments
- » Kills more than 99.99% of most common germs that may cause foodborne illness including: E. coli, Listeria, Salmonella and Campylobacter
- » Meets Food Code Hand Sanitizers criteria
- » Hypoallergenic, Dermatologist tested, Dye free

ITEM #	ORDER #	DESCRIPTION	UOM
5055-1W	35400802	Starter Kit: 1 Dispenser / 1 Refill	CS
5054-02	35400708	1200 mL Refill for Dispenser	2/CS



8145-06



8150-12



8745-D1



GOJO® HAND MEDIC® Professional Skin Conditioner

- » Fragrance-free skin conditioner, specially formulated for industrial environments
- » Helps prevent dry, cracked skin by maintaining skin's moisture level
- » Absorbs quickly with no greasy after-feel
- » Silicone and fragrance free
- » Latex glove compatible
- » NSF E4 Registered

ITEM #	ORDER #	DESCRIPTION	UOM
8745-D1	354087461	Starter Kit: 1 Dispenser / 1 Refill	EA
8745-04	35408745	700 mL Refill for Dispenser	4/CS
8142-12	35408142	2 fl oz Bottle	12/CS
8145-06	35408145	8 fl oz Bottle w/ Pump Disp	6/CS
8150-12	35408150	5 fl oz Tube	12/CS



9605-24

PURELL® Advanced Hand Sanitizer Gel

- » Refreshing gel
- » Kills more than 99.99% of most common germs that may cause illness

ITEM #	ORDER #	DESCRIPTION	UOM
9652-12	35405212	8 fl oz Pump Bottle	12/CS
9605-24	35400524	2 fl oz PERSONAL™ Bottle	24/CS



Wipes & Cleaners



Kimtech® Prep Wipers for Bleach Disinfectants and Sanitizers

- » Wipers have durable meltblown construction, for saturated wiping with sanitizers, bleach and disinfectants; just pour in the cleaner you choose
- » Cuts solvent usage by 20% using the Wettask® closed bucket; significantly reduces solvent waste and VOC emissions
- » Enclosed system also helps eliminate exposure to chemical vapors and splashes and (with disposable wipers) is an ideal alternative to an open bucket and eliminates the need for laundering contaminated cloth rags

ITEM #	ORDER #	DESCRIPTION	UOM
06411	15406264	White, 12" x 12.5"	6 RI/Cs



06411



36101



Kimtech® Wettask® Dual Performance Wiping System

- » The 2-in-1 durable meltblown construction wipers have a textured, purple side with tough scrubbing power and a soft white side for regular cleaning
- » Cuts solvent usage by 20% using the Wettask® closed bucket; significantly reduces solvent waste and VOC emissions
- » Enclosed system also helps eliminate exposure to chemical vapors and splashes and (with disposable wipers) is an ideal alternative to an open bucket and eliminates the need for laundering cloth rags

ITEM #	ORDER #	DESCRIPTION	UOM
36101	15400234	Purple and White, 12" x 12.5"	6 RI/Cs



Kimtech® Wettask® Wipers for Solvents

- » Feature strong Hydroknit construction, for saturated wiping with solvents; just pour in the cleaner you choose
- » Cuts solvent usage by 20% using the Wettask® closed bucket; significantly reduces solvent waste and VOC emissions
- » Enclosed system also helps eliminate exposure to chemical vapors and splashes and (with disposable wipers) is an ideal alternative to an open bucket and eliminates the need for laundering cloth rags

ITEM #	ORDER #	DESCRIPTION	UOM
06001	15405290	White, 12" x 12.5"	6 RI/Cs



06001



75260



Scott® Rags In A Box

- » Strong, durable, and multi-purpose towels that feel and perform like a cloth
- » Made of cellulose fibers with a latex binder for thickness, absorbency and strength
- » Designed for wet or dry-cleaning applications
- » Box with built-in handle

ITEM #	ORDER #	DESCRIPTION	UOM
75260	15405260	White, 10" x 12"	8 Bx/Cs



Wipes & Cleaners



Scott® Shop Towels

- » Each shop paper towel is ultra-strong, durable and works well even when wet
- » Use them for cleaning, refilling fluids and general maintenance

ITEM #	ORDER #	DESCRIPTION	UOM
Towels on a Roll			
75130	15405130	Blue, 11" x 10.4"	30 RI/Cs
Towels in a Box			
75190	15405190	Blue, 10" x 12"	8 Bx/Cs



75130



75190



05812



Wypall* L30 Towels

- » Ideal for a wide range of light-duty healthcare/patient wiping, maintenance, processing and janitorial wiping tasks
- » Features (DRC) Double Re-Creping technology, high surface softness and a reinforced grid for strength
- » Quarter-folded for easy storage

ITEM #	ORDER #	DESCRIPTION	UOM
05812	15405812	White, 12.5" x 12"	12 Pk/Cs



Wypall* Waterless Cleaning Wipes

- » Disposable industrial cleaning wipes are pre-saturated with an alcohol-free natural citrus cleaning agent for the waterless cleansing of skin and hard surfaces
- » 2-in-1 wipe, one textured side for scrubbing and one smooth side for wiping dirt off surfaces and hands

ITEM #	ORDER #	DESCRIPTION	UOM
Bucket with 75 Wipes			
91371	154013711	Green and White, 9.5" x 12"	PK
Canister with 50 Wipes			
58310	15408310	Green and White, 9.5" x 12"	8/Cs



91371



Wipes & Cleaners



Wypall* X80 Cloths

- » Reinforced for extra scrubbing power
- » Doesn't fall apart when tackling the most demanding jobs - even in solvents
- » Rinse and reuse - reduce waste and cost

ITEM #	ORDER #	DESCRIPTION	UOM
41041	15401041	Blue, 12.5" x 16.8"	1/Cs



41041



42272



SCRUBS In-A-Bucket® Hand Cleaner Towels

- » Clean, citrus fragrance
- » Advanced cleaning power
- » For use on hands and surfaces, no sticky residue
- » NO SOAP! NO WATER! NO PROBLEM!™
- » Remove: dirt, tar, oils, grease, paints, adhesives, epoxies, caulks, inks and dyes, urethanes, lubricants, "Icky-PIC", cable jelly, asphalt

ITEM #	ORDER #	DESCRIPTION	UOM
42272	311222721	72 Towel Container	EA



SCRUBS® Hand Sanitizer Wipes

- » Kills 99.9% of germs, broad spectrum
- » Dissolves Bio-film
- » Prevents cross-contamination
- » Replaces alcohol gels, which do not remove contaminants
- » Can be used where soap and water are not available

ITEM #	ORDER #	DESCRIPTION	UOM
90985	311209851	85 Wipe Container	EA



90985



26832



Spray Nine® Multi-Purpose Cleaner & Disinfectant

- » Cleans
- » Degreaser
- » Disinfects against viruses in 30 seconds
- » Disinfect against bacteria in 45 seconds
- » Sanitizes in 10 seconds
- » Kills fungus in 3 minutes
- » Deodorizes
- » Controls mold & mildew
- » Removes stains

ITEM #	ORDER #	DESCRIPTION	UOM
26832	A3440002	Multi-Purpose Heavy Duty Cleaner, 32 oz.	12/Cs

⚠ WARNING: Cancer and Reproductive Harm - www.P65Warnings.ca.gov

Sorbents



AW1818



ALLWIK® Universal Absorbent Pillows

- » 18" x 18" pillow
- » 28 gallon absorbency capacity
- » Designed for use in tight spaces, under valves or under machinery lifted off the floor, pillows provide the greatest absorbency per square inch
- » Highly versatile, grey absorbents pick up water-based, petroleum-based and non-aggressive, chemical fluids
- » Made of all-purpose polypropylene suitable for most industrial applications

ITEM #	ORDER #	DESCRIPTION	UOM
AW1818	J0520014	18" x 18" Absorbent Pillow	16/CS



DTA25



ALLWIK® Universal Absorbent Drum Top Covers

- » 22 inch diameter
- » 6 gallon absorbency capacity
- » Help to maintain clean work surfaces by preventing pump spills and overspray from reaching the floor
- » Highly versatile, grey absorbents pick up water-based, petroleum-based and non-aggressive, chemical fluids
- » Made of all-purpose polypropylene suitable for most industrial applications

ITEM #	ORDER #	DESCRIPTION	UOM
DTA25	J0520004	22" Dia, Drum Top Cover	25/CS



ALLWIK® Universal Absorbent Socks



AW124

- » Moldable SOCs wrap around machinery and conform to uneven surfaces to prevent leaks from reaching walkways
- » Highly versatile, grey absorbents pick up water-based, petroleum-based and non-aggressive, chemical fluids
- » Gray color masks spills and stains, helping you resist the urge to pick up the absorbent before it is fully saturated
- » Made of all-purpose polypropylene suitable for most industrial applications

ITEM #	ORDER #	DESCRIPTION	UOM
AW124	J0520016	3" x 12', 12 Gallon Absorbency per case	4/CS
AW412	J0520017	3" x 4', 12 Gallon Absorbency per case	12/CS



BASIC® Universal Absorbent Sock



BSC40

- » 3" x 42" pads
- » 81 gallon absorbency capacity
- » Moldable SOCs wrap around machinery and conform to uneven surfaces to prevent leaks from reaching walkways
- » Highly versatile, grey absorbents pick up water-based, petroleum-based and non-aggressive, chemical fluids

ITEM #	ORDER #	DESCRIPTION	UOM
BSC40	J0520015	3" x 42", 81 Gallon Absorbency per case	40/CS



Oil Only Absorbent Socks



OIL412

- » 3" x 4' pads
- » 12 gallon absorbency capacity
- » White absorbents pick up petroleum-based fluids, paints and non-water soluble chemicals while repelling water - great for indoor & outdoor use
- » Oil Only absorbents are unaffected by temperature and impervious to rot and mildew
- » Floats indefinitely even when saturated with oil

ITEM #	ORDER #	DESCRIPTION	UOM
OIL412	J0520023	3" x 4', 12 Gallon Absorbency per case	12/CS

Sorbents

SORBENTS



MRO Plus® Universal Absorbent Pads



MRO100

- » 15" x 19" pads
- » Highly versatile, grey absorbents pick up water-based, petroleum-based and non-aggressive, chemical fluids
- » 3-ply Meltblown Polypropylene construction is designed for general industrial applications
- » Perforations provide cost control and reduce waste by allowing you to use only what you need

ITEM #	ORDER #	DESCRIPTION	UOM
MRO100	J0520005	Heavy Weight, 26 Gal Absorbency	100/CS
MRO300	J0520008	Medium Weight, 20.5 Gal Absorbency	100/CS



BASIC® Universal Absorbent Pads



BPU100

- » 15" x 17" pads
- » Highly versatile, grey absorbents pick up water-based, petroleum-based and non-aggressive, chemical fluids
- » BASIC Series meltblown polypropylene absorbents feature economical, single-ply construction
- » Perforations provide cost control and reduce waste by allowing you to use only what you need

ITEM #	ORDER #	DESCRIPTION	UOM
BPU100	J0520012	Heavy Weight, 26 Gal Absorbency	100/CS
BPU200	J0520013	Light Weight, 34 Gal Absorbency	200/CS



BASIC® Oil Only Absorbent Pads



BPO200

- » 15" x 17" pads
- » White absorbents pick up petroleum-based fluids, paints and non-water soluble chemicals while repelling water - great for indoor & outdoor use
- » BASIC Series meltblown polypropylene absorbents feature economical, single-ply construction
- » Perforations provide cost control and reduce waste by allowing you to use only what you need

ITEM #	ORDER #	DESCRIPTION	UOM
BPO100	J0520010	Heavy Weight, 20.5 Gal Absorbency	100/CS
BPO200	J0520011	Light Weight, 34 Gal Absorbency	200/CS



SPC® Oil Only Absorbent Pads



SPC300

- » 15" x 19" pads
- » White absorbents pick up petroleum-based fluids, paints and non-water soluble chemicals while repelling water - great for indoor & outdoor use
- » SPC® absorbents are made with MAXX® Technology for superior absorbency and greater strength without the added weight
- » Perforations provide cost control and reduce waste by allowing you to use only what you need

ITEM #	ORDER #	DESCRIPTION	UOM
SPC100	J0520007	Heavy Weight, 35 Gal Absorbency	100/CS
SPC300	J0520006	Medium Weight, 30 Gal Absorbency	100/CS
SPC200	J0520009	Light Weight, 51 Gal Absorbency	200/CS



ALLWIK® Portable Economy Spill Control Kit - Universal Application



SKA-PP

- » 5 gallon absorbency capacity
- » Includes: (10) 15 in x 19 in Pads, (2) 3 in x 4 ft Socks, Disposal Bag, Instruction Sheet, Nitrile Gloves
- » Yellow PVC Bag offers high visibility spill control storage so items can be quickly located in an emergency situation
- » Improve worker productivity and efficiency by placing spill kits around your facility close to areas prone to spills
- » Portable spill kits are ideal for fast spill response

ITEM #	ORDER #	DESCRIPTION	UOM
SKA-PP	J0520019	Portable Economy Spill Control Kit	1/CS

Sorbents



SKA-BKT



ALLWIK® 6.5-Gallon Bucket Spill Control Kit - Universal Application

- » 9 gallon absorbency capacity
- » Includes: (10) 15 in x 19 in Pads, (3) 3 in x 4 ft Socks, Disposal Bag, Instruction Sheet, Nitrile Gloves
- » Highly versatile, grey absorbents pick up water-based, petroleum-based and non-aggressive, chemical fluids
- » Improve worker productivity and efficiency by placing spill kits around your facility close to areas prone to spills
- » Spill kits are ideal for fast response to critical accidents

ITEM #	ORDER #	DESCRIPTION	UOM
SKA-BKT	J0520018	6.56 Gallon Spill Control Kit	1/CS



T-270

3M™ Petroleum Sorbent Booms

- » For use in oil-only sorbent applications
- » Scrim encased tube of particulate sorbent material is secured by netting
- » Built in attachment clips are provided at each end of the boom, allowing booms to be linked together
- » Unique double-cylinder design maximizes absorption and minimizes the escape of traces of oil in flowing water
- » UV resistant; will not deteriorate or disintegrate
- » Recommended for use in ditches, streams, rivers, lakes, and terminal docks and piers

ITEM #	ORDER #	DESCRIPTION	UOM
T-270	66550855	8" x 10'/Boom: 20 Gal/Boom	4/CS
T-280	66550856	(2) 4" x 10'/Booms: 10 Gal/Boom	4/CS



3M™ Maintenance Sorbent Folded Environmental Safety Product, High Capacity



M-FL550DD

- » For use on most non-aggressive liquids
- » Four sorbents in one - use as a boom, pillow, pad, or roll
- » Perforations every 16" allow you to select the length desired
- » Each perforated sheet unfolds to approximately 18" x 16" – gray

ITEM #	ORDER #	DESCRIPTION	UOM
M-FL550DD	66550793	Absorption: 10.5 Gal/Box/ 31.5 Gal/Case	3 BX/CS



T-151



3M™ Petroleum Sorbent Pad Environmental Safety Products

- » For use in oil-only sorbent applications
- » Pads are conveniently sized
- » White, 17" x 19"

ITEM #	ORDER #	DESCRIPTION	UOM
T-151	66550853	Absorption: 43.5 Gal/Case	200/CS



3M™ Chemical Sorbent Pad Environmental Safety Product

P-110



- » For use on most aggressive (hazardous) and non-aggressive liquids
- » Conveniently sized and packaged in a dispenser box
- » Ideal for cleaning up small spills and wiping down contaminated areas
- » A scrim on one side to increase strength and eliminate linting

ITEM #	ORDER #	DESCRIPTION	UOM
P-110	66550802	11" x 13"/Box: 17 Gal/Case	4 BX/CS



Hazard Storage

HAZARD STORAGE



55 Gallon Safety Drum Cover

- » Turn ordinary drums into fire-safe waste collection centers
- » Simply use a screwdriver and wrench to attach the cover to a drum
- » Spring-loaded cover slams shut in case of fire
- » Durable steel construction with powder-coat finish
- » Excellent chemical resistance



26750

WARNING: Cancer and Reproductive Harm - www.P65Warnings.ca.gov

ITEM #	ORDER #	UOM
26750	B61614361	EA



EcoPolyBlend™ Drum Accumulation Center

- » EcoPolyBlend™ black is 100% recycled polyethylene and yellow is 30% recycled
- » Resist chemical attack from hazardous acids, caustics and solvents
- » Seamless construction eliminates leaks, making these ideal for drum filling and dispensing operations
- » Self-locating grates won't ride-up and are removable for easy cleaning
- » EPA, SPCC compliant and meets fire codes

Ships Direct FOB Mfg.



28657

ITEM #	ORDER #	DESCRIPTION	UOM
28657	B6168657	4 Drum Unit, Black, 49"W x 5.5"H x 49"D	EA
28656	B6168656	4 Drum Unit, Yellow, 49"W x 5.5"H x 49"D	EA
28623	B6168623	2 Drum Unit w/ Oversized Sump, 49"W x 18"H x 25"D	EA



09300



Oily Waste Cans

- » Dispose of oil-soaked rags
- » Foot operated lid opens to no more than 60° and stays closed when not in use
- » Prevent fires caused by stray sparks or spontaneous combustion
- » Round construction and elevated base allow circulation of air to disperse heat
- » Steel construction with powder-coat finish provides chemical resistance
- » Ten-year warranty - OSHA compliant
- » Approved by FM, UL/ULC and TUV

ITEM #	ORDER #	DESCRIPTION	UOM
09100	B61606921	6 Gal, 15.875"H x 11.875" Outer Dia.	EA
09300	B61606971	10 Gal, 18.25"H x 13.938" Outer Dia.	EA
09500	B61607011	14 Gal, 20.25"H x 16.063" Outer Dia.	EA
09700	B61607041	21 Gal, 23.438"H x 18.375" Outer Dia.	EA



Smokers Cease Fire® Cigarette Butt Receptacles

- » Innovative self-extinguishing design
- » Made of flame-retardant and sturdy polyethylene
- » Galvanized collection steel bucket
- » Tie-down notches offer security and stability
- » Fire tested and FM-approved

ITEM #	ORDER #	DESCRIPTION	UOM
26800D	B6160003	Deco Black, 4 Gal, 38.5" H x 16.5" Outer Dia.	EA
26800	B6160010	Pewter Gray, 4 Gal, 38.5" H x 16.5" Outer Dia.	EA
26800B	B6160001	Adobe Beige, 4 Gal, 38.5" H x 16.5" Outer Dia.	EA



26800D

26800

26800B



Hazard Storage



Sure-Grip® EX Countertop and Compac Safety Cabinets for Flammables

- » Protect workers, reduce fire risks and improve productivity by storing flammables and chemicals in code-compliant safety cabinets
- » 18-gauge (1-mm) thick double-wall construction, welded steel with 1.5" (38 mm) of insulating air space for fire resistance
- » High-performance, self-latching doors
- » U-Loc™ handle comes with a cylinder lock and key set or accepts an optional padlock
- » Patented SpillSlope® galvanized steel shelf directs spills to leak-proof bottom sump
- » Lead-free epoxy/polyester powder-coat finish provides chemical resistance
- » Ten-year warranty - OSHA and NFPA compliant

Ships Direct **FOB Mfg.**



890400



891200

ITEM #	ORDER #	DESCRIPTION	UOM
890400	B6164400	4 Gal Countertop, Manual Closing Door, 22" H x 17" W x 17" D	EA
890420	B6161801	*4 Gal Countertop, Self-Closing Door, 22" H x 17" W x 17" D	EA

FM Approved

891200	B6161796	12 Gal, Manual Closing Door, 35" H x 23.25" W x 18" D	EA
891220	B6161803	*12 Gal, Self-Closing Door, 35" H x 23.25" W x 18" D	EA

* **WARNING:** Cancer and Reproductive Harm - www.P65Warnings.ca.gov



Sure-Grip® EX Safety Cabinets for Flammables

- » Protect workers, reduce fire risks, and improve productivity by storing flammables and chemicals in code-compliant safety cabinets
- » 18-gauge (1 mm) thick double-wall construction, welded steel with 1.5" (38-mm) of insulating air space for fire resistance
- » High-performance, self-latching doors
- » U-Loc™ handle comes with a cylinder lock and key set or accepts an optional padlock
- » Patented SpillSlope® galvanized steel shelf directs spills to leak-proof bottom sump
- » Cabinets have dual vents with flame arresters, four adjustable self-leveling feet, grounding connector and trilingual warning label
- » Lead-free epoxy/polyester powder-coat finish provides chemical resistance
- » Ten-year warranty - OSHA and NFPA compliant, FM approved



896020

Ships Direct **FOB Mfg.**

ITEM #	ORDER #	DESCRIPTION	UOM
30 Gal Cabinets (44"H x 43"W x 18"D)			
893000	B6168930	2 Doors, 1 Shelf, Manual Closing Door	EA
893020	B6163020	*2 Doors, 1 Shelf, Self-Closing Door	EA
45 Gal Cabinets (65"H x 43"W x 18"D)			
894500	B61611021	2 Doors, 2 Shelves, Manual Closing Door	EA
894520	B6164520	2 Doors, 2 Shelves, Self-Closing Door	EA
60 Gal Cabinets (65"H x 34"W x 34"D)			
896000	B6166000	2 Doors, 2 Shelves, Manual Closing Door	EA
896020	B6161795	2 Doors, 2 Shelves, Self-Closing Door	EA

* **WARNING:** Cancer and Reproductive Harm - www.P65Warnings.ca.gov



Hazard Storage

HAZARD STORAGE



Type I Steel Safety Cans

- » High-grade coated steel, each can is tested to guarantee 100% leak-proof construction
- » Single spout for filling and pouring
- » Sealed lid features automatic positive-pressure relief that vents between 3 and 5 psig (0.2 and 0.35 bar) to guard against rupture or explosion
- » Cans equipped with a stainless-steel flame arrester which dissipates heat to stop flashback ignition
- » Durable steel construction with powder-coat finish
- » OSHA and NFPA compliant
- » Approved by FM, UL/ULC and TUV



10301



7150110



7150200

ITEM #	ORDER #	DESCRIPTION	UOM
Red, Type I Flammable Fuel			
10301	B61607181	1 Gal w/ Trigger Handle, 11.5"H x 7.25" Outer Dia.	EA
7110100	B61621001	1 Gal w/ Swinging Handle, 11"H x 9.5" Outer Dia.	EA
7120100	B61631001	2 Gal w/ Swinging Handle, 13.75"H x 9.5" Outer Dia.	EA
7125100	B61651001	2.5 Gal w/ Swinging Handle, 11.5"H x 11.75" Outer Dia.	EA
7150100	B61618091	5 Gal w/ Swinging Handle, 16.875"H x 11.75" Outer Dia.	EA
7150110	B61651101	5 Gal w/ Funnel, Swinging Handle, 16.875"H x 11.75" Outer Dia.	EA
Yellow, Type I Diesel Fuel			
7150200	B61652001	5 Gal w/ Swinging Handle, 16.875"H x 11.75" Outer Dia.	EA
Polyethylene Funnel			
11202Y	B61608451	For 1 Gal Cans and Above, 11.25"L x 0.5" Outer Dia.	EA



Type II AccuFlow™ Steel Safety Cans

- » Easy-to-use Safe-Squeeze® trigger for controlled pouring
- » Two-openings; one for targeted pouring, one with lift-lever for easy filling
- » Flexible 9" (229 mm) long metal hose spout helps control the pour into small openings
- » Sealed lid features automatic positive-pressure relief that vents between 3 and 5 psig (0.2 and 0.35 bar) to guard against rupture or explosion
- » Cans equipped with a stainless-steel flame arrester which dissipates heat to stop flashback ignition
- » Durable steel construction with powder-coat finish, each can is pressure tested
- » Ten-year warranty - OSHA and NFPA compliant
- » Approved by FM, UL/ULC and TUV
- » 17.5" H x 11.75" Outer Dia.



7250120

ITEM #	ORDER #	DESCRIPTION	UOM
7250120	B61661201	5 Gal w/ 0.625" Dia. Hose	EA
7250130	B61631301	5 Gal w/ 1" Dia. Hose	EA

Industrial Markers



DYKEM
Brand

83314

Cross Check™ Torque Seal® Tamper-Proof Indicator

- » Tamper proof torque mark
- » Safe for most surfaces, excellent adhesion
- » Highly visible, detects loose nuts and bolts
- » Provides warranty protection
- » Fluorescent under black/UV light
- » Boeing Specification: BMS8-45 Type II

ITEM #	ORDER #	DESCRIPTION	UOM
83314	31120048	Orange Paste, 2 oz. Tube	24/Cs



84001



84002



41006



41008

DYKEM
Brand

BRITE-MARK® General Purpose Markers

- » General-purpose, permanent paint markers
- » Durable, UV-resistant
- » Dries in 25-35 seconds
- » Contains more paint than competitive paint markers
- » Marks on virtually any surface
- » Valve actuated tip prevents paint in barrel from drying when cap is left off

ITEM #	ORDER #	DESCRIPTION	UOM
Medium Tip			
84001	31124001	Blue	12/Cs
84002	311240025	Black	12/Cs
84003	31124003	White	12/Cs
84004	31120009	Yellow	12/Cs
Fine Tip			
41001	31121001	Blue	12/Cs
41003	31121003	Black	12/Cs
41006	31120011	Yellow	12/Cs
41008	31120001	White	12/Cs



84202



84203

DYKEM
Brand

BRITE-MARK® ROUGHNECK Plastic Tip Markers

- » Writes longer with more paint than competitive paint makers
- » Plastic tip resists fraying and disintegrating when used on rough surfaces
- » Tip repels oil and grease and can be wiped clean
- » Industrial-grade UV resistant paint withstands harsh outdoor conditions

ITEM #	ORDER #	DESCRIPTION	UOM
84202	31120005	Black	12/Cs
84203	311200065	White	12/Cs
84204	31120008	Yellow	12/Cs



16033



16063

DYKEM
Brand

TEXPEN® Industrial Steel Tip Paint Marker

- » Medium barrel holds large capacity of product
- » Stainless steel ball tip – no risk of tip wear, even when writing on rough concrete or rusty metal
- » Writes through oil, grease and water
- » Writes at all angles, even upside down
- » Paint withstands extreme weather conditions without losing legibility or brightness
- » Drying time: 25-35 minutes

ITEM #	ORDER #	DESCRIPTION	UOM
Steel Fine Tip			
16030	31120012	Black	12/Cs
16060	31120016	Yellow	12/Cs
16080	31120018	White	12/Cs
Steel Medium Tip			
16033	31120021	Black	12/Cs
16063	31120029	Yellow	12/Cs
16083	31120030	White	12/Cs
Steel Broad Tip			
16064	31120031	Yellow	12/Cs
16084	31120034	White	12/Cs



DALO® Industrial Steel Tip Paint Marker

- » Large barrel holds large capacity of product, minimizing replacement time
- » Stainless steel ball tip – no risk of tip wear, even when writing on rough concrete or rusty metal
- » Writes through oil, grease and water
- » Writes at all angles, even upside down
- » Paint withstands extreme weather conditions without losing legibility or brightness
- » Drying time: 25-35 minutes

ITEM #	ORDER #	DESCRIPTION	UOM
Steel Medium Tip			
26033	31120035	Black	6/Cs
26063	31120038	Yellow	6/Cs
26083	31120039	White	6/Cs



HIGH PURITY Marker

- » Permanent marks will not etch stainless steel
- » Certified low-chloride, low-halogen and low-contaminant ink
- » Meet Nuclear, GE Energy, GE Aviation and a wide range of industry-accepted specs

ITEM #	ORDER #	DESCRIPTION	UOM
Fine Tip			
33404	31120042	Black	12/Cs
33729	31120043	White	12/Cs



HIGH PURITY TXP Marker

- » Certified by an outside laboratory
- » Contain trace amounts of halogens, low melting point elements and chlorides
- » Meet or exceed the requirements of the US Energy Research & Development Administrations Nuclear Grade for black, yellow and white
- » Writes through oil and grease without losing legibility or brightness

ITEM #	ORDER #	DESCRIPTION	UOM
17463	31120047	Medium Tip, White	12/Cs

Industrial Markers



26033



26063



26083

ITEM #	ORDER #	DESCRIPTION	UOM
Steel Broad Tip			
26064	31120040	Yellow	6/Cs
26084	31120041	White	6/Cs



44404



44729



44916

ITEM #	ORDER #	DESCRIPTION	UOM
Threaded Cap, Medium Tip			
44404	31120044	Black	12/Cs
44729	31120045	White	12/Cs
44916	31120046	Yellow	12/Cs



17463

Safety & Area Marking Tape



ToughStripe® Floor Marking Tape Roll

- » Visible floor-marking improves safety and organization in almost any industrial environment
- » High-gloss surface shines like new paint and withstands forklift traffic without tearing or lifting
- » Ideal for marking aisles, passageways and storage locations and identifying equipment and egress paths

ITEM #	ORDER #	DESCRIPTION	UOM
2" x 100'			
104311	J05200581	White	RL
104312	J05200531	Yellow	RL
104313	J05200511	Red	RL
104314	J05200461	Blue	RL
104315	J05200641	Green	RL
104316	J05200541	Orange	RL
104317	J05200561	Black/Yellow Strip	RL
3" x 100'			
104342	J05200491	Yellow	RL
104347	J05200631	Black/Yellow Strip	RL
4" x 100'			
104372	J05200601	Yellow	RL
104377	J05200651	Black/Yellow Strip	RL



104377

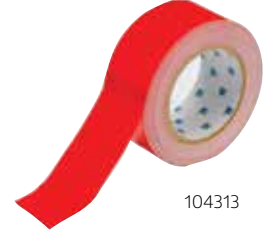

104313



91420



91423



Pipe Marking Directional Flow Arrow Tape Vinyl

- » High gloss, durable, flexible vinyl with a permanent cold temperature pressure sensitive acrylic adhesive
- » Good chemical, oil and water resistance
- » Item comes in end-user packaging for use in point-of-purchase displays
- » Supplied in liner-mounted rolled form - use two bands per pipe marker

ITEM #	ORDER #	DESCRIPTION	UOM
2" x 30 yd			
91420	J05201081	Yellow/Black Arrows	RL
91421	J05201091	Green/White Arrows	RL
91423	J05201101	Blue/White Arrows	RL
1" x 30 yd			
91424	J05201111	Yellow/Black Arrows	RL
91425	J05201121	Green/White Arrows	RL



ToughStripe® Floor Corner L-Shaped Marking Tape, Yellow

- » Visible floor-marking improves safety and organization in almost any industrial environment
- » High-gloss surface shines like new paint and withstands forklift traffic without tearing or lifting
- » Ideal for marking corners of work cells and storage locations
- » Can be easily applied by one person
- » 2" wide x 5" long



104433

ITEM #	ORDER #	DESCRIPTION	UOM
104433	J05201005	Corner L-Shaped Marking Tape	20/Pk

Masking Tape



70006745700

3M

3M™ High Performance Green Masking Tape 401+

- » Removes cleanly in one piece with no adhesive residue
- » Remains in place around corners, over contours and irregular surfaces
- » Resists paint bleed-through to help create sharp paint lines
- » Green backing improves visibility and accuracy during paint masking
- » Withstands surface temperatures up to 250°F/121°C for 30 minutes in paint bake operations

ITEM #	ORDER #	DESCRIPTION	UOM
70006745700	66552726	24 mm x 55 m, 6.7 mil Thick	24/Cs
70006745718	66552727	36 mm x 55 m, 6.7 mil Thick	16/Cs
70006745726	66552728	48 mm x 55 m, 6.7 mil Thick	12/Cs
70006745734	665527291	72 mm x 55 m, 6.7 mil Thick	8/Cs

3M

3M™ High Performance Yellow Masking Tape 301+

- » Proprietary, solvent-free adhesive formula removes cleanly in one-piece with no adhesive residue
- » Withstands surface temperatures up to 225°F/107°C for 30 minutes
- » Resists paint bleed-through to help create good paint lines
- » Sticks with confidence on rubber moldings, plastic, glass, wood, concrete, metal and painted surfaces
- » Yellow backing improves visibility and accuracy during paint masking
- » Remains in place around corners, over contours and irregular surfaces



70006745635

ITEM #	ORDER #	DESCRIPTION	UOM
70006745635	66554199	72 mm x 55 m, 6.3 mil Thick	12/Cs

3M

3M™ General Purpose Tan Masking Tape 231/231A

- » Rubber adhesive provides strong tack and adhesion and resists lifting
- » Clean removal from many surfaces following multi-bake or high temperature bake
- » Smooth mini-crepe paper backing conforms and maintains integrity when formed around a corner
- » Strong backing is easy to tear, yet resists slivering and provides one-piece removal
- » Controlled unwind dispenses evenly, reducing fatigue



GT500030199

ITEM #	ORDER #	DESCRIPTION	UOM
GT500030199	66552491	24 mm x 55 m, 7.6 mil Thick	36/Cs
GT500030215	66554200	48 mm x 55 m, 7.6 mil Thick	24/Cs

3M

3M™ General Purpose Tan Masking Tape 234

- » Strong backing is easy to tear, yet resists slivering and provides one-piece removal
- » Rubber adhesive provides instant adhesion and resists lifting or curling, yet still removes easily
- » Crepe paper backing conforms and maintains integrity when formed around a corner
- » Performs well in paint bake operations up to 250°F for 30 minutes
- » Manufactured without solvents for reduced environmental impact

ITEM #	ORDER #	DESCRIPTION	UOM
70006319290	665542021	24 mm x 55 m, 5.9 mil Thick	RL
70006319308	665531101	48 mm x 55 m, 5.9 mil Thick	RL



70006319290

Masking Tape

3M

Scotch® Green Fine Line Tape 218

- » High-performance polypropylene plastic tape
- » Thin tape provides excellent color line separation
- » Proven excellent for painting long straight lines and smooth curves
- » Resistant to most solvents and moisture
- » Resists heat in bake cycles that reach 250°F/121°C for up to 30 minutes



70006028693

ITEM #	ORDER #	DESCRIPTION	UOM
70006028693	665537881	2" x 60 yd., 5.0 mil Thick	RL



GT500015844

3M

3M™ Performance Tan Masking Tape 2380

- » Provides strong holding power and exceptional high-temperature resistance
- » Resists slivering when exposed to high heat
- » Removes cleanly after 30 minutes at bake temperatures up to 325°F/162°C
- » Heavy crepe paper backing resists bleed-through
- » Adhesive bonds instantly to many surfaces, holding in place without lifting or curling
- » Strong backing is easy to tear and provides one-piece removal

ITEM #	ORDER #	DESCRIPTION	UOM
GT500015844	665538701	48 mm x 55 m, 7.3 mil Thick	RL

3M

3M™ Tan Masking Tape 2307

- » General purpose tape for woodworking
- » Rubber adhesive offers broad tack and moderate adhesion
- » Crepe-paper backing conforms over irregular surfaces, contours and around corners

ITEM #	ORDER #	DESCRIPTION	UOM
70006159522	66553264	24 mm x 55 m, 5.2 mil Thick	36/Cs



70006159522

Duct Tape

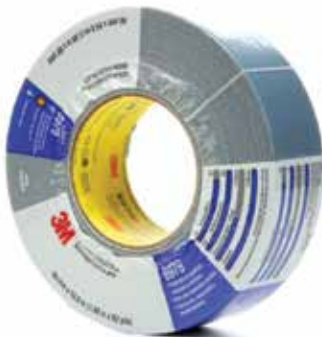

3M

3M™ Performance Plus Slate Blue Duct Tape 8979

- » Removes cleanly for up to six months from most opaque surfaces even after UV exposure to sun and outdoor weathering
- » Sticks immediately and stays on for up to one-year without deterioration
- » Strong water-resistant backing resists wear and light abrasion
- » Provides a tight, moisture-resistant seal in many containment situations
- » Conforms to irregular surfaces without lifting

ITEM #	ORDER #	DESCRIPTION	UOM
70006413457	665542051	48 mm x 54.8 m, 12.1 mil Thick	RL
70006413465	665542041	72 mm x 54.8 m, 12.1 mil Thick	RL

Duct Tape



3M™ Silver Duct Tape

- » For use in MRO/construction applications
- » Removes cleanly for up to three months when applied indoors
- » Sticks immediately and stays on for up to one-year without deterioration
- » Water-resistant backing resists wear and light abrasion
- » Provides a tight, moisture-resistant seal in many containment situations
- » Conforms to irregular surfaces without lifting



70006720661



70006250602



70006250172

ITEM #	ORDER #	DESCRIPTION	UOM
48 mm x 54.8 m, (1.88" x 60 yd.)			
70006720661	665542311	Value 1900, 5.8 mil Thick	RL
70006250602	665508291	Multi-Purpose 3900, 7.7 mil Thick	RL
70006250172	665516461	Extra Heavy-Duty 6969, 10.7 mil Thick	RL



70006413572



3M™ Performance Plus Duct Tape 8979N

- » Resists UV, sunlight and weather to stay on for up to one-year without deterioration
- » Distinctive red and slate blue color available
- » Complies with MIL-STD-2041D(SH), Notice 2 for leachable halides and sulfur
- » Curl-resistant, moisture-resistant and conformable backing for easy handling
- » Removes cleanly from most opaque surfaces after up to six months of UV exposure and weather



70006356003

ITEM #	ORDER #	DESCRIPTION	UOM
Slate Blue			
70006413564	66554208	48 mm x 54.8 m, 12.1 mil Thick	24/Cs
70006413572	66554214	72 mm x 54.8 m, 12.1 mil Thick	12/Cs
Nuclear Red			
70006355997	66554215	48 mm x 54.8 m, 12.1 mil Thick	24/Cs
70006356003	66554216	72 mm x 54.8 m, 12.1 mil Thick	12/Cs



70005025054



3M™ Poly & Tarps Gray Duct Tape

- » High adhesion to heavy-weight poly
- » High tensile strength that resists tearing
- » Great for repairing tarps and securing drop cloths
- » Water resistant and temperature flexible
- » Conformable for a tight, long-lasting seal
- » UL 723 compliant

ITEM #	ORDER #	DESCRIPTION	UOM
70005025054	66552977	48 mm x 54.8 m, (1.88" x 60 yd.)	9/Cs



3M™ Vinyl Yellow Duct Tape 3903

- » Rubber adhesive sticks fast and stays fast on many surfaces, even irregular surfaces
- » Embossed vinyl backing seals out dust, dirt and moisture and resists abrasion and many chemicals
- » Peels off cleanly after 30 minutes on painted steel as hot as 200°F (93°C)
- » Easy to tear and conforms to irregular surfaces



70007507034

ITEM #	ORDER #	DESCRIPTION	UOM
70007507034	66553983	2" x 50 yd., 6.5 mil Thick	24/Cs

Electrical Tape



80610833867

WARNING: Cancer - www.P65Warnings.ca.gov



Scotch® Professional Grade Vinyl Electrical Tape Super 88

- » The combination of the pressure-sensitive, rubber-resin adhesive and the PVC backing offers excellent electrical and mechanical protection
- » Provides high resistance to UV rays, abrasion, moisture, alkalis, acids and corrosion
- » Withstands a temperature range of 0° to 221°F (-18° to 105°C)
- » Provides a protective jacket and electrical insulation for splices and cables
- » Tensile strength rating of 20 lbs. per inch
- » UL Listed, CSA Certified and RoHS 2011/65/EU Compliant

ITEM #	ORDER #	DESCRIPTION	UOM
80610833867	665525431	Black PVC, 0.75" x 66 ft., 8.5 mil Thick	RL



Scotch® Super 33+™ Vinyl Electrical Tape

- » The combination of the pressure-sensitive, rubber-resin adhesive and the PVC backing offers excellent electrical and mechanical protection
- » Provides high resistance to UV rays, abrasion, moisture, alkalis, acids and corrosion
- » Withstands a temperature range of 0° to 221°F (-18° to 105°C)
- » Compatible with rubber and synthetic splicing compounds
- » Tensile strength rating of 15 lbs. per inch
- » UL Listed, CSA Certified and RoHS 2011/65/EU Compliant

WARNING: Cancer - www.P65Warnings.ca.gov



80610833834

ITEM #	ORDER #	DESCRIPTION	UOM
80610833834	665515681	Black PVC, 0.75" x 66 ft., 7 mil Thick	RL



Scotch® Vinyl Color Coding Red Electrical Tape 35

- » Electrical and mechanical protection from combined pressure-sensitive, rubber-resin adhesive and PVC backing
- » Suitable for use in phase identification, color coding of motor leads and piping systems and for marking safety areas
- » Withstands a temperature range of 32° to 221°F (0° to 105°C)
- » Tensile strength rating of 17 lbs. per inch
- » UL Listed, CSA Certified and RoHS 2011/65/EU Compliant

WARNING: Cancer - www.P65Warnings.ca.gov



80610833909

ITEM #	ORDER #	DESCRIPTION	UOM
80610833909	665539091	Red PVC, 0.75" x 66 ft., 7 mil Thick	RL

Painter's Tape



ScotchBlue™ Original Painter's Tape 2090

- » Ideal for use on smooth or lightly textured walls, trim, glass and metal
- » Sharp paint lines on a variety of surfaces
- » Removes cleanly up to 14 days with no sticky residue
- » Medium adhesion level removes easily, while protecting your surfaces
- » Indoor or outdoor use



70006960200

ITEM #	ORDER #	DESCRIPTION	UOM
70006960200	665537855	48 mm x 54.8 m, (1.88" x 60 yd.), 5.4 mil Thick	6/Pk
70006576543	665530651	48 mm x 54.8 m, (1.88" x 60 yd.), 5.4 mil Thick	RL



Specialty Tape



70006658192

3M

3M™ High Performance Double Coated Tape 9086

- » Double coated tape with tissue carrier, acrylic adhesive
- » High tack, immediate bond, quick stick, high adhesion and good initial adhesion
- » Solvent resistant
- » Bonds to a wide variety of materials and substrates

ITEM #	ORDER #	DESCRIPTION	UOM
70006658192	665530721	White, 1" x 55 yd., 7.5 mil Thick	RL



70006006301

3M

3M™ Adhesive Transfer Tape Extended Liner

- » Pressure sensitive adhesives
- » Dry edge and finger lift edge liners
- » Tack free tape roll edges for ease of use
- » Easy liner starting and removal

ITEM #	ORDER #	DESCRIPTION	UOM
70006006301	66554163	Translucent, 0.75" x 1000 yd., 1.0 mil Thick	9/Cs



7000028907

3M

Scotch® Box Sealing Tape 375

- » High edge tear and split resistance
- » Polypropylene backing with synthetic rubber adhesive
- » Easy unwind and smooth dispensing
- » Resists abrasion, moisture, chemicals and scuffing
- » Excellent adhesion to recycled liner paper and fiberboard

ITEM #	ORDER #	DESCRIPTION	UOM
7000028907	665537511	Clear, 48 mm x 50 m, 3.1 mil Thick	RL
70006182920	665538611	Tan, 48 mm x 50 m, 3.1 mil Thick	RL



70006295037

3M

3M™ Impact Stripping Tape 528

- » Tan, durable backing protects against a variety of blasting media
- » Acrylic adhesive provides reliable bond
- » Adhesive helps ensure clean, one-piece removal without residue
- » Easy release paper liner makes for efficient die-cutting

ITEM #	ORDER #	DESCRIPTION	UOM
70006295037	665538461	Tan, 4" x 20 yd., 85.0 mil Thick	RL

3M

3M™ Preservation Sealing Tape 481

- » Effective for many outdoor applications with quick, clean removal when finished
- » Helps preserve equipment and vehicles for long-term storage of at least two years
- » Can be certified to Military Specification: SAE AMS-T-22085
- » Resistance to staining, common lubricants and strippable coatings on a variety of surfaces
- » Polyethylene backing

ITEM #	ORDER #	DESCRIPTION	UOM
70006021078	665538621	Black, 2" x 36 yd., 9.5 mil Thick	RL



70006021078

Specialty Tape

3M

3M™ All Weather Flashing Tape 8067

- » Apply at surface temperatures as low as 0°F (-18°C) or high as 176°F (80°C)
- » Resists UV exposure for up to 12 months
- » Passes nail sealability before and after thermal cycling according to AAMA 711-05
- » Bonds to most common building materials without primers and staples
- » Service temperature -40° to 240°F (-40° to 116°C)
- » No adverse reaction with many building sealants
- » Split-liner for easy and accurate positioning of tape, especially long lengths



70006745015

ITEM #	ORDER #	DESCRIPTION	UOM
70006745015	665539881	Tan, 4" x 75 ft., Slit Liner	RL

Spray Adhesives



62497749309

3M

3M™ Super 77™ Multipurpose Spray Adhesive

- » Provides professional, industrial strength for demanding applications
- » Bonds paper, cardboard, fabric, insulation, plastic, metal, wood and more
- » Allows for a bond time of 15 seconds to 30 minutes
- » Repositionable while providing long-lasting strength

ITEM #	ORDER #	DESCRIPTION	UOM
62497749309	66550012	Aerosol, 24 Fluid Oz., Net. Wt. 16.75 oz.	12/Cs

3M

3M™ Foam Fast 74 Spray Adhesive

- » Designed specifically for foams and fabrics
- » Dispenses with a lace-spray pattern optimized for foam bonding
- » Provides professional, industrial strength for demanding applications
- » Offers a fast, aggressive tack for a quick assembly of high-stress bonds
- » Allows for a bond time of 15 seconds to 30 minutes

ITEM #	ORDER #	DESCRIPTION	UOM
62493549505	66553866	Orange Aerosol, 24 Fluid Oz., Net. Wt. 16.9 oz.	12/Cs
62495049504	66554225	Clear Aerosol, 24 Fluid Oz., Net. Wt. 16.9 oz.	12/Cs



62493549505



62493349500

3M

3M™ Pressure Sensitive Spray Adhesive 72

- » Pressure sensitive adhesive gains strength as pressure is applied
- » Permanent tack ideal for many one-surface bond applications
- » Low soak-in formula keeps adhesive on the surface
- » Long open time allows bonds to be made hours or days after application
- » Variable width lace spray pattern allows for precise dispensing

ITEM #	ORDER #	DESCRIPTION	UOM
62493349500	66554224	Aerosol, 24 Fluid Oz., Net. Wt. 17.3 oz.	12/Cs



Barricade Tape

BARRICADE TAPE



T15101



T15102



T20103

Barricade Tape CAUTION

- » Yellow, 3-Inch Width
- » Non-Toxic, Non-Flammable
- » UV Resistant Ink, Lead Free
- » High Strength, Remains Flexible in Cold Weather
- » 1000 Feet Per Roll

ITEM #	ORDER #	DESCRIPTION	UOM
CAUTION			
T15101	346301371	1.5 Mil, CAUTION	EA
T20101	346301421	2.0 Mil, CAUTION	EA
CAUTION DO NOT ENTER			
T15102	346301381	1.5 Mil, CAUTION DO NOT ENTER	EA
T20102	346301431	2.0 Mil, CAUTION DO NOT ENTER	EA
Bilingual CAUTION/CAUIDADO			
T20103	346301441	2.0 Mil, CAUTION/CAUIDADO	EA

Barricade Tape DANGER

- » Red, 3-Inch Width
- » Non-Toxic, Non-Flammable
- » UV Resistant Ink, Lead Free
- » High Strength, Remains Flexible in Cold Weather
- » 1000 Feet Per Roll

ITEM #	ORDER #	DESCRIPTION	UOM
DANGER			
T15211	346301391	1.5 Mil, DANGER	EA
T20211	346301451	2.0 Mil, DANGER	EA
DANGER DO NOT ENTER			
T15212	346301411	1.5 Mil, DANGER DO NOT ENTER	EA
T20212	346301461	2.0 Mil, DANGER DO NOT ENTER	EA
Bilingual DANGER/PELIGRO			
T20213	346301471	2.0 Mil, DANGER/PELIGRO	EA



T15101



T15102



T20103



Air Horns



Mega Blast Rechargeable Siren Horn

- » Rechargeable via the included USB plug and adapter
- » Extremely loud: 122dB
- » Weatherproof & shock resistant solid state electronics
- » Meets U.S. Coast Guard requirements
- » Great for camping, boating, hiking, and job sites
- » No need to replace air canisters, or carry an air pump to re-fill

ITEM #	ORDER #	DESCRIPTION	UOM
65805	J41200041	Rechargeable Siren Horn	EA

⚠ WARNING: Cancer and Reproductive Harm - www.P65Warnings.ca.gov



Portable Air Horns

- » Environmentally friendly
- » Ideal for construction work sites
- » Meets all coast guard requirements

ITEM #	ORDER #	DESCRIPTION	UOM
29112	J1190001	Sport Air Horn, 1.8 oz	12/CS
6580823	J4120001	Big Horn Air Horn, 125 decibels	12/CS
2000281	J4120002	Big Horn Air Horn replacement cartridge	12/CS



⚠ WARNING: Cancer and Reproductive Harm - www.P65Warnings.ca.gov

AED



Automated External Defibrillators (AEDs)

AED Plus Fully Automatic Defibrillator

- » Real CPR Help provides real-time CPR feedback on the rate and depth of chest compressions
- » Easy-to-place, one-piece CPR-D-padz® electrodes with a 5-year shelf life
- » Unit will deliver a shock on its own when a shockable heart rhythm is detected

AED Plus Semi Automatic Defibrillator

- » Real CPR Help provides real-time CPR feedback on the rate and depth of chest compressions
- » Easy-to-place, one-piece CPR-D-padz® electrodes with a 5-year shelf life
- » Can withstand conditions like extreme temperature, altitude, vibration, and shock



ITEM #	ORDER #	DESCRIPTION	UOM
8000-004007-01	C35080011	AED Plus Fully Auto medical prescription case	EA
8000-004000-01	C35080021	AED Plus Semi Auto medical prescription case	EA
8900-0800-01	C35000021	CPR-D padz with accessory kit	EA
8000-0855	C3500007	AED cabinet with alarm	EA

⚠ WARNING: Cancer and Reproductive Harm - www.P65Warnings.ca.gov



Manufacturer Index



3M Company www.mmm.com
 Eye Protection 3 - 8, 29, 33 - 34, 38
 Head & Face Protection 40 - 41
 Hearing Protection 54 - 58, 67 - 69
 Respiratory Protection 73 - 76, 84 - 88, 95 - 96
 Sorbents 282
 Tapes & Adhesives 289 - 294
 Welding & FR Safety 146 - 147
DBI Sala
 Fall Protection 165 - 167, 173 - 178, 183, 185, 189 - 192
DBI Sala Python Safety
 Fall Protection for Tools 169 - 170
Protecta
 Fall Protection 165, 167, 179, 185, 193



Allegro Industries www.allegrosafety.com
 Confined Space 245 - 247
 Respiratory Protection 97 - 98



Ansell Edmont Industrial Inc. www.ansellpro.com
 Cold Weather Gear 215
 Hand Protection 103, 112, 116 - 120, 128 - 129



Brady Products www.bradyid.com
 Area Tape 288
 Lockout/Tagout 268 - 272
 Sorbents 280 - 282



Bollé www.bollesafety-usa.com
 Eye Protection 24 - 28



Bullard www.bullard.com
 Head & Face Protection 41 - 43



Certified Safety Mfg. www.certifiedsafetymfg.com
 First Aid 253 - 258



Coleman www.coleman.com
 Heat Stress 251
 Lighting 238



DuPont Personal Protection www.dupont.com
 Protective Clothing 201 - 209, 212



Duracell www.duracell.com
 Lighting 240



Energizer www.energizer.com
 Lighting 236, 240



Ergodyne www.ergodyne.com
 Cold Weather Gear 218
 Ergonomics 162
 Fall Protection 171
 Footwear 160
 Hand Protection 138
 Heat Stress 252



Fiamm www.fiamm.com
 Emergency Response 296



Gateway Safety www.gatewayssafety.com
 Eye Protection 24, 34
 Respiratory Protection 82



Gerson, Inc. www.gersonco.com
 Respiratory Protection 82 - 83

Manufacturer Index



GOJO Industries, Inc. www.gojo.com
Wipes & Cleaners275 - 276



Guardian Equipment www.gesafety.com
Shower & Eyewash 264 - 267



HexArmor www.hexarmor.com
Eye Protection 2 - 3
Hand Protection 99 - 102, 110

Honeywell

Honeywell www.honeywell.com
Hand Protection 104
Instrumentation 241
Lockout/Tagout273 - 274
Protective Clothing 212
Shower & Eyewash 262 - 263

Fibre-Metal

Head & Face Protection44, 46 - 47
Welding & FR Safety 150

Howard Leight

Hearing Protection 59 - 62, 70 - 71

Miller

Fall Protection 166 - 168, 170, 180 - 182, 186 - 187, 194

North Safety Products

Cold Weather Gear 215
First Aid 259 - 261
Hand Protection 113, 121, 130, 132, 134
Head & Face Protection 44 - 45
Respiratory Protection81, 90 - 92

Servus

Footwear161

Uvex

Eye Protection 9 - 15, 30, 35 - 36, 39
Head & Face Protection 45
Welding & FR Safety 150



Ironclad www.ironclad.com
Hand Protection104, 134, 138 - 140, 159



ITW Pro Brands www.itwprobrands.com
Wipes & Cleaners 279
Industrial Markers 286 - 287



John Tillman & Co. www.jtillman.com
Cold Weather Gear 216
Hand Protection125 - 126, 136, 140 - 141
Welding & FR Safety151 - 159



Justrite Manufacturing Co. www.justrite.com
Hazardous Storage 283 - 285



Kimberly-Clark Corp. www.kcprofessional.com
Eye Protection15 - 17, 31 - 32, 37
Hand Protection104, 120, 129 - 130
Protective Clothing 210 - 211
Wipes & Cleaners277 - 279



Majestic Glove www.majesticglove.com
Cold Weather Gear 217, 220
Hand Protection105, 126, 130 - 131, 141 - 142
Hi-Viz Apparel 229 - 230



MCR Safety www.mcrcsafety.com
Cold Weather Gear 216 - 217
Eye Protection18 - 21, 32, 36, 38
Hand Protection105 - 106, 110 - 111, 121, 126, 131 - 132, 136 - 137, 142
Head & Face Protection 49
Hi-Viz Apparel 225
Protective Clothing212 - 214



Mechanix Wear www.mechanix.com
Hand Protection 107, 143 - 145



ML Kishigo www.mlkishigo.com
Hi-Viz Apparel221 - 224



Moldex-Metric, Inc. www.moldex.com
Hearing Protection63 - 66, 72
Respiratory Protection76 - 81, 88 - 90



Manufacturer Index



MSA Safety Incorporated www.msasafety.com
 Cold Weather Gear 218
 Fall Protection 166, 168, 182 - 183, 188, 194
 Head & Face Protection 50 - 52
 Instrumentation 241 - 244
 Respiratory Protection 93 - 94



Occunomix International, Inc. www.occunomix.com
 Cold Weather Gear 215, 218 - 220
 Ergonomics 162 - 163
 Head & Face Protection 52 - 53
 Heat Stress 252
 Hi-Viz Apparel 226 - 228



Pelican www.pelican.com
 Lighting 237 - 239



Guardian Fall Protection www.guardianfall.com
 Fall Protection 164, 172 - 173, 184, 189



Radians www.radians.com
 Eye Protection 22, 30, 38



SAS Safety Corp. www.sassafety.com
 Eye Protection 23, 34
 Hand Protection 121 - 123, 127 - 128
 Hi-Viz Apparel 226
 Respiratory Protection 82
 Shower & Eyewash 262



Showa www.showagloves.com
 Hand Protection 107, 113 - 114, 123 - 124, 132 - 133



Sqwincher Corporation www.sqwincher.com
 Heat Stress 248 - 251



Streamlight, Inc. www.streamlight.com
 Lighting 231 - 235



Stearns www.coleman.com
 Water Safety 195 - 200



Surewerx www.surewerx.com
 Cold Weather Gear 218
 Head & Face Protection 47 - 49
 Welding & FR Safety 147 - 150



Weldas Company www.weldas.com
 Head & Face Protection 53



Wells Lamont Industrial wellslamontindustrial.com
 Cold Weather Gear 216
 Hand Protection 108 - 109, 111, 114, 127, 133 - 135, 137, 145



Zoll Medical Corporation www.zoll.com
 Emergency Response 296

Product Index

A

Absorbent Pads	281–282
Absorbent Pillows	280
Absorbent Socks	280
Adapters & Brackets, faceshield	43, 46–49
Air Blowers, confined space ventilation	245–247
Air Horns	296
mega blast rechargeable siren horn	296
portable air horns	296
Air Quality, detection	241–242
Anchors & Connectors, fall protection	164–166
ANSI Class Apparel	221–230
Apparel, hi-viz	213, 220–221
Aprons	
disposable	206, 210
leather & FR	153
Arc Flash Protection	151–153
Area Lighting Systems	239
Automated External Defibrillators (AEDs)	296
Automatic Inflation Vests	199
Axial Blowers, ventilation	245–247

B

Backhand Pads	159
Back Supports, ergonomics	162
Bandanas & Doo Rags	252
Banded Earplugs	54, 61, 63
Barricade Tape	295
Batteries	239–240
Beam Anchors, fall protection	164–166
Beverage Coolers	251
Bibs, leather	153
Bloodborne Pathogen First Aid Kits	258–259
Blowers, confined space	245–247
Body & Eyewash Shower Units	266–267
Body Fluid Spill Kit	275
Boots	161
Box Sealing Tape	293
Brackets, headgear & faceshield	40–41, 43, 45–50
Breaker Lockouts	268, 273
Bucket, fall protection	169
Buoy, water safety	195

C

Cabinets, flammable storage	284
Cable Lockouts	268, 273
Calibration, gas	243
Cans, safety	285
Cape Sleeves, welding	151–153
Cap Mount Earmuffs	67, 69–72

Caps & Hard Hats	40–42, 44, 47, 51–53
Carabiners, fall protection	166
Cartridges & Filters, respiratory	87, 89–90, 92, 94–95
Caution Barricade Tape	295
Chemical Protection Apparel	201
Chemical Resistant Gloves	112–114
Chemical Sorbents	280–282
Cigarette Butt Receptacles	283
Circuit Breaker Lockout Devices	268, 274
Class A First Aid	253–255
Class B Field Trauma Bag	257
Class B First Aid	255–257
Cleaning, respiratory	98
Cleaner, lens	38–39
Clothing, protective	201–214
Cold Water Immersion Suits	200
Cold Weather Gear	215–220
apparel	220
footwear	218
gloves	215–217
head liners	218–219
Combination Shower & Eyewash Units	267
Confined Space	245–247
blowers	245–247
Manhole Accessories	247
Containment & Spill Control	280–282
Coolers, beverage	251
Cooling Towels	252
Countertop Storage Cabinets	284
Coveralls, disposable	201–206, 210–211
Cut-Resistant Gloves	100–109
Cut-Resistant Sleeves	110–111
Cylinders, calibration gas	243

D

Detectors, gas	241–244
Disposable	
apparel	201–212
earplugs	54–66
gloves	115–124
respirators	73–83
Doo Rags	53
Double Functionality Flashlights	233
Drench Hose, eyewash units	266
D-Rings, fall protection	167
Drinks, electrolyte	248–250
Drivers Gloves	125–127
Drum Accumulation Center	283
Drum Cover	283
Duct Tape	290–291



E

- Earmuffs 67-72
- Earplugs 54-66
- Electrical Gloves 127-128
- Electrical Plug Lockouts 268, 274
- Electrical Safety, lockout/tagout 268-274
- Electrical Tape 292
- Electrolyte Drinks 248-250
- Emergency Escape Respirator 92
- Emergency Response 296**
 - air horns 296
 - automated external defibrillators (AEDs) 296
 - first aid kits 253-261
 - water safety / rescue 195-200
- Ergonomics 162-163**
 - back supports 162
 - knee pads 163
 - ring and watch guards 163
 - wrist supports 162
- Eye Protection 2-39**
 - eyewash units 262-267
 - goggles 33-37
 - lens cleaning 38-39
 - readers & magnifiers 30-32
 - safety glasses 2-29
 - side shields 38
 - welding 146-150
- Eyesaline Saline Solution 262-263
- Eyewash & Showers 262-267**
 - combination units 267
 - drench hose units 266
 - permanent units 264-267
 - personal 262
 - portable 262-264
 - refill solution 263
- Eyewash Stations 262-266

F

- Faceshields & Visors 40-41, 43, 46-50
- Fall Limiters, fall protection 167-168
- Fall Protection 164-194**
 - anchors 164-166
 - arc flash & welding 176, 180, 182
 - beam anchors 164-166
 - carabiners 166
 - D-Rings 167
 - fall limiters 167-168
 - fall protection for tools 169-171
 - harnesses 172-183
 - hoist system 183
 - lanyards 184-188
 - lifelines 189-194
 - limiters 167-168

- manhole guard system 194
- positioning device 184
- rope grabs & restraints 191
- SRLs 189-194
- trauma strap 184, 192
- Filters & Cartridges, respiratory 87, 89-90, 92, 94-95
- First Aid 253-261**
 - bloodborne pathogen 258-259
 - Class A 253-255
 - Class B 255-257
 - eyewash & showers 262-267
 - field trauma bag 257
 - heat stress 258
 - insect repellent 261
 - kits & cabinets 253-261
 - skin creams 261
- Fit Testing, respiratory 97
- Flame-Resistant Apparel 151-153
- Flammable Storage 284
- Flashlights 231-238
- Flotation Gear, water safety 195
- Footwear 160-161**
 - ice traction devices 160
 - knee boots 161
 - over boots 161
- Freezer Pops, electrolytes 250
- Full Facepiece Respirators 84, 86, 89-91, 93-94

G

- Gas Detection 241-244**
 - calibration cylinders 243
 - gas regulators 244
 - multigas detectors 241-242
 - single gas detectors 241
- General Purpose Gloves 128-133
- Glasses, Safety 2-29
- Gloves**
 - backhand pads 159
 - chemical-resistant 112-114
 - cut-resistant 100
 - cut-resistant sleeves 110-111
 - disposable 115-124
 - drivers 125-127
 - electrical 127-128
 - general purpose 128-133
 - leather and work gloves 136-137
 - needlestick resistant 99
 - puncture resistant 99
 - trade & utility 138-145
 - welders 154-159
- Goggles 33-37
- Group Lock Boxes 270, 274
- Guard Rails, manhole 194



H

Half Facepiece Respirators 85–86, 88–89, 91–93
 Hand Cleaner 275, 279
Hand Protection 99–145
 backhand pads 159
 chemical-resistant 112–114
 cut-resistant 100–109
 cut-resistant sleeves 110–111
 disposable 115–124
 drivers 125–127
 electrical 127–128
 general purpose 128–133
 hand warmers 215
 heat resistant 134–135
 insulated gloves 215–217
 leather and work gloves 136–137
 needlestick resistant 99
 puncture resistant 99
 trade & utility 138–145
 Welders 154–159
 Hand Sanitizer 276, 279
 Hand Soap 276
 Hand Warmers 215
 Hard Hats & Caps 40–42, 44, 47–49
 Harnesses 172–183
Hazardous Storage 283–285
 cigarette butt receptacles 283
 containment 283
 oily waste cans 283
 safety cabinets 284
 spill pallets 283
 steel safety cans 285
Head & Face Protection 40–53
 brackets & adapters 43, 47–50
 faceshields & visors 40–41, 43, 45–50
 hard hats & caps 40–42, 44, 47, 51–53
 spray socks 98
 suspensions 50
 sweatbands & doo rags 42, 50, 53
 welding helmets 146–150
 winter liners 218, 219
 Headlamps 231–232, 236, 238
Hearing Protection 54–72
 banded earplugs 54, 61, 63
 detectable 56, 59, 61, 63, 65
 dispensers 57, 62, 64–66
 earmuffs 67–72
 earplugs 54–66
 radio headsets 69
Heat Resistant
 apparel 151–153
 gloves 134–135, 154–159

Heat Stress 248–252
 bandanas & doo rags 252
 coolers 251
 cooling towels 252
 electrolyte drinks 248–250
 hard hat shade 252
 sweatbands 252
 Heat Stress First Aid Kit 258
 Helmets, welding 146–150
 Highway Safety, apparel 221–230
Hi-Viz Apparel 221–230
 class 2 apparel 221–229
 class 3 apparel 228, 230
 jackets 220, 230
 non-compliant apparel 225–226
 overall pants 229
 rainwear 213
 shirts 223, 228
 sweatshirts 220, 228, 230
 vests 221–229
 Hoist System, fall protection 183
 Horizontal Lifelines, fall protection 192

I

Ice Rescue Suits, water safety 200
 Ice Traction Devices 160, 218
 Impact Resistant Gloves 138–145
 Industrial Markers 286–287
 Insect Repellent 261
Instrumentation
 gas detection 241–244
 Insulated Gloves 215–217

J

Jackets
 ANSI Class 220, 230
 cold weather 220, 230
 flotation 195–199
 FR, welding 151–152
 rainwear 213–214

K

Kits
 fall protection 173, 179
 first aid 253–261
 gas calibration 244
 Knee Boots 161
 Knee Pads, ergonomics 163

L

Lab Coats 207–208
 Ladder Safety, fall protection 191



Lanterns 238–239

Lanyards, fall protection 184–188

Leading Edge, fall protection 188, 193

Leather and Work Gloves 136–137

Leather Apparel 152–153

Lens Cleaning Stations 38–39

Lid Lifter, manhole 247

Life Jackets, water safety 195–199

Lighting 231–240

 batteries 239–240

 double functionality 233

 headlamps 231–232, 236, 238

 lanterns 238

 propolymers 234

 rechargeable 231

 remote area lighting 239

 small flashlights 235, 237

 work lights 236

Lithium Batteries 239

Lockout/Tagout 268–274

 cable lockout 268, 273

 circuit breaker lockout 268, 274

 group lock boxes 270, 274

 hasps 268, 273

 padlocks 271–272

 plug lockout 268, 274

 stations 270

 tags 269

 valve lockouts 269, 273

Lumbar & Back Supports 162

M

Magnifiers & Readers, eyewear 30–32

Maintenance Sorbents 280–282

Manhole Safety 247

 accessories 247

 lid lifter 247

 manhole guard system 194

 ventilation 245–247

Masking Tape 289–290

Multigas Detectors 241–242

N

Needlestick Resistant Gloves 99

O

Oily Waste Cans 283

Over Boots, footwear 161

P

Padlocks, lockout/tagout 271–272

Pads, sorbents 280–282

Painter's Tape 292

PAPR (Powered Air Purifying Respirators) 95–97

Particulate Respirators 73–83

Petroleum Sorbents 280–282

Plug Lockout Devices 268, 274

Ponchos, rainwear 214

Portable Eyewash Station 262–264

Protective Clothing 201–214

 aprons 206, 210

 booties 208–210

 cold weather 215–220

 coveralls 201–208, 210–211

 disposable 201–212

 frocks 207–208

 hi-viz 221–230

 hoods 208

 jackets 230

 lab coats 207–208

 pants 207

 rainwear 213–214

 shirts 223, 228

 sleeves 212

 sweatshirts 228, 230

 welding 151–153

 winter liners 218–219

Puncture-Resistant Gloves 99

R

Radio Earmuffs 69

Rags, shop 277

Rainwear 213–214

Readers, eyewear 30–32

Rechargeable Flashlights 231

Reflective Apparel 195–200, 213, 220–230

Regulators, gas detection 244

Remediation Kit, mold 86

Remote Area Lighting Systems 239

Rescue Bags, water safety 195

Rescue Suits, water safety 200

Respiratory Protection 73–98

 cartridges & filters 87, 89–90, 92, 94

 cleaning pads 98

 disposable 73–83

 fit test kits 97

 hoods 88

 locker 80

 mold remediation 86

 PAPRs 95–97

 reusable 84–94

 spray socks 98

 storage bags 98

 welding 75, 80

Retractable Lifelines, fall protection 189–194

Reusable Earplugs 57–59, 61–63, 65–66

Reusable Respirators 84–94
 Ring and Watch Guards, ergonomics 163
 Ring Buoy, water safety 195
 Roof Anchors, fall protection 164–165
 Rubber Boots 161

S

Safety & Area Marking Tape 288
 Safety Cabinets 284
 Safety/Cover Lenses, welding 151
 Safety Eyewear 2–37
 Safety Glasses 2–29
 Saline, eyewash 262–263
 Shoe & Boot Covers 208–209
Showers & Eyewash Stations 262–267
 combination units 267
 drench hose units 266
 permanent units 264–267
 personal 262
 portable 262–264
 refill solution 263
 Side Shields, eye protection 38
 Single Gas Detectors 241
 Small Flashlights 235, 237
Sorbents 280–282
 absorbent pads 281–282
 absorbent pillows 280
 absorbent socks 280
 spill control kit 281–282
 Spats, leather 153
 Specialty Tape 293–294
 Spill Control Kit 281–282
 Spray Adhesives 294
 Spray Socks 98
 SRLs, fall protection 189–194
 Steel Safety Cans 285
 STOP/SLOW Sign 224
 Storage Bags, respiratory 98
 Surface Disinfectant 275, 279
 Sweatbands 252
 Sweatbands, hard hats 42, 50, 53
 Sweatshirts 220, 228–229

T

Tactical Lights 237
Tapes & Adhesives 288–294
 box sealing tape 293
 duct tape 290–291
 electrical tape 292
 masking tape 289–290
 painter’s tape 292

safety & area marking tape 288
 specialty tape 293–294
 spray adhesives 294
 Tethers, fall protection 169–171
 Tool Lanyards, fall protection 169–171
 Towels, shop 278
 Trade & Utility Gloves 138–145

Traffic & Work Zone Safety

 hi-viz apparel 221–230
 manhole guard system 194
 Trauma Strap, fall protection 184, 192
 T-Shirts 223, 228

V

Valve Lockout Devices 269, 273
Vests
 flotation 195–199
 hi-viz 221–229
 Visors & Faceshields 40–41, 43, 45–50

W

Wall Mounted Eyewash Stations 265
 Warning Flag 224
Water Safety 195–200
 automatic inflation vests 199
 buoys 195
 flotation vests 195–199
 immersion suits 200
 rescue bag 195
 rescue suits 200
Welding & FR Safety 146–159
 apparel 151–153
 backhand pads 159
 fall protection 176, 180, 182
 flotation 196
 gloves 154–159
 helmets & filters 146–150
 lenses & goggles 150–151
 PAPRs 150
 Winter Apparel & Gloves 215–220
 Winter Liners 218–219
Wipes & Cleaners 275–279
 body fluid spill kit 275
 hand cleaner 275, 279
 hand sanitizer 276, 279
 hand soap 276
 rags 277–278
 surface disinfectant 275, 279
 wipes 277–279
 Work Lights 236
 Wrist Support, ergonomics 162–163



Distributing the BEST Safety Products!

Westcoast Industries was started by a top producing OSHA certified Qualified Safety Sales Professional in the Gas, Welding, Construction and Manufacturing industry for 8+ years and is proud to be Woman and Minority owned. We are small by design and customize our product offerings and inventory based on our customers' needs and preferences. We believe in Quality over Quantity so we only take on a small number of customers in order to focus 100% of our time on helping them grow and servicing all of their needs, from on time order delivery to conducting safety consultations and trainings.



Westcoast Industries

Marina Del Rey, CA 90292
310-651-1038

sales@westcoast-industries.com
www.westcoast-industries.com





Westcoast Industries

Marina Del Rey, CA 90292

310-651-1038

sales@westcoast-industries.com

www.westcoast-industries.com

3M Science.
Applied to Life.™

Style. Comfort. Performance. It's a Triple Threat.

On-the-job eye protection shouldn't mean sacrificing style and comfort. The 3M™ SecureFit™ 400 with Scotchgard™ Anti-fog series offers style, comfort and increased anti-fog performance with 3M™ Scotchgard™ Anti-fog coating.

These sleek new models are available in contemporary colors to reflect personal style with proprietary 3M™ Pressure Diffusion Temple Technology to enhance frame comfort without compromising the security of fit.

